

**Modelling Legal Argument:
Reasoning with Cases
and Hypotheticals**

**A Ph.D. Dissertation by
Kevin D. Ashley**

COINS Technical Report 88-01

**Department of Computer and Information Science
University of Massachusetts
Amherst, Massachusetts 01003**

**Modelling Legal Argument:
Reasoning with Cases and Hypotheticals**

**A Dissertation Presented
by
Kevin D. Ashley**

**Submitted to the Graduate School of the
University of Massachusetts in partial fulfillment
of the requirements for the degree of**

DOCTOR OF PHILOSOPHY

February, 1988

Department of Computer and Information Science

©Copyright by Kevin D. Ashley 1987
All Rights Reserved

National Science Foundation, Grant IST-8212238

Advanced Research Projects Agency, Department of Defense
Monitored by Office of Naval Research
Contract No. N00014-84-K-0017
Contract No. N00014-87-K-0238

University Research Initiative, Award No. N00014-86-K-0764

IBM Graduate Student Fellowship

Modelling Legal Argument: Reasoning with Cases and Hypotheticals

A Dissertation Presented
by
Kevin D. Ashley

Approved as to style and content by:

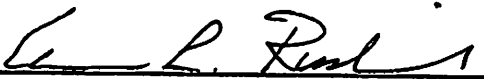

Edwina L. Rissland, Chairperson of Committee



Wendy G. Lehnert, Member

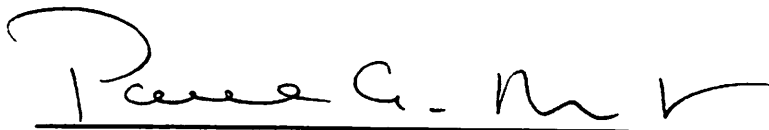

Paul A. Brest, Outside Member

W. Richards Adrion, Chairman
Department of Computer and Information Science
University of Massachusetts

Acknowledgments

Edwina Rissland has been the chairperson of my dissertation committee and my mentor throughout my graduate school career. She teaches by example to look beyond the bounds of ones own expertise, to be energetic and creative in searching for ideas and ways to test them, and to “structure, structure, structure” prose. Her overriding concern on behalf of her students has always been to get them to “think good thoughts”. Working with Edwina, it is hard not to.

As members of the dissertation committee, Wendy Lehnert and Paul Brest have helped me to see how the dissertation fits into the larger pictures of AI research and jurisprudential theory. Wendy has helped me to deal with the problems of conveying what was essential from the legal domain to a non-legal audience. I am especially grateful to Paul for taking the time to review the dissertation despite his professional commitments as the new Dean of the Stanford Law School.

Most of all, I thank my wife Alida who has supported me in my peregrinations through Harvard Law School, a Wall Street legal practice, graduate school in computer science, and most particularly through this dissertation. Her wise counsel, unflagging optimism and patient understanding are the mainstays of my life.

Abstract

**Modelling Legal Argument:
Reasoning with Cases and Hypotheticals**

February, 1988

Kevin D. Ashley, B.A. Princeton University
J.D., Harvard Law School
M.A., University of Massachusetts
Ph.D., University of Massachusetts

Directed by: Professor Edwina L. Rissland

This dissertation is about adversarial, case-based reasoning and the *HYPO* program that performs adversarial reasoning with cases and hypotheticals in the legal domain. The dissertation identifies and describes basic case-based operations, an adversarial, case-based reasoning process, a schematic structure for case-based arguments, the kinds of counter-examples that arise and the knowledge sources necessary to support adversarial, case-based reasoning.

The *HYPO* program embodies the methodology. It comprises: (1) a structured Case Knowledge Base ("CKB") of actual legal cases; (2) an indexing scheme ("dimensions") for retrieval of relevant cases from the CKB; (3) methods for analyzing problem situations and retrieving relevant cases; (4) methods for interpreting and assessing the relevancy of past cases by "positioning" the problem

situation with respect to relevant existing cases in the CKB as seen from the viewpoint of the problem at hand and finding the most-on-point cases; (5) methods for comparing/contrasting cases (e.g., citing, distinguishing, finding counter-examples); (6) methods for posing hypotheticals that test the sensitivity of the problem situation to changes, particularly with regard to potentially adverse effects of new damaging facts coming to light and existing favorable ones being discredited; (7) methods for generating "3-ply" argument outlines to play out realistic legal arguments citing cases in a manner familiar to attorneys; and (8) methods for explaining alternative decisions of the problem situation by posing hypotheticals, comparing arguments and summarizing the precedents. HYPO's performance compares favorably to that of judges and attorneys in actual legal cases.

The law is an excellent domain to study case-based reasoning since by its very nature it: (1) espouses a doctrine of precedent in which prior cases are the primary tools for justifying legal conclusions; and (2) employs precedential reasoning to make up for the lack of strong domain models with which to reason deductively about problem situations. The law is also a paradigm for *adversarial* case-based reasoning; there are "no right answers", only arguments pitting interpretations of cases and facts against each other.

The dissertation addresses issues of central concern to Artificial Intelligence including: relevance and credit assignment, indexing and inference control, argumentation, analogical reasoning and explanation.

Table of Contents

ACKNOWLEDGMENTS	iv
ABSTRACT	v
LIST OF FIGURES	xiii
CHAPTERS	
1. INTRODUCTION	1
1.1 Adversarial Reasoning	1
1.2 Adversarial, Case-Based Reasoning	4
1.3 Adversarial, Case-Based Reasoning in the Law	6
1.4 Chapter Guide to Dissertation	8
2. ADVERSARIAL REASONING WITH CASES	11
2.1 Adversarial Reasoning with Cases – A Prosaic Example	11
2.2 An Adversarial, Case-Based Reasoning Process	16
2.3 Advantages of Adversarial, Case-Based Reasoning	18
2.4 Problems for Computationally Implementing Adversarial, Case-Based Reasoning	21
2.5 Related Research	25
2.5.1 Argument Discourse	26
2.5.2 Analogical Reasoning	31
2.5.3 Case-Based Reasoning and Memory Organization	35
2.5.4 Example-Based Reasoning	37
2.5.5 Explanation	38
2.5.6 AI Models of Legal Reasoning	43

3. THE LAW AS A PARADIGM OF CASE-BASED ARGUMENT	52
3.1 A Scenario	52
3.2 What a Legal Argument Should Be	54
3.2.1 Justifying by Citing Precedents	56
3.2.2 What Precedents to Cite in a Point	57
3.2.3 Responding to Precedents	59
3.2.4 What About Other Facts?	61
3.2.5 Evaluating a Legal Argument	62
3.2.6 Finding the Cases	63
3.3 The Role of Hypotheticals in Legal Argument	66
3.4 Analogies in Law	72
4. THE HYPO PROGRAM: AN OVERVIEW	81
4.1 Knowledge Sources in HYPO	82
4.2 HYPO's Reasoning Process	87
4.3 HYPO's Architecture	88
4.3.1 Introduction to HYPO's Component Modules	88
4.3.2 Flow of Control in HYPO	89
4.3.3 The Basic Processing Loop	90
4.4 Detail of HYPO's Modules	95
4.4.1 SESSION MANAGER	95
4.4.2 CASE-ANALYZER	95
4.4.3 CASE POSITIONER	100
4.4.4 BEST-CASE-SELECTOR	102
4.4.5 3-PLY-ARGUER	104
4.4.6 HYPO-GENERATOR	112
4.4.7 EXPLAINER	113
4.4.8 CASE EDITOR	117
4.5 Reader's Guide	118

5. HYPO IN ACTION: EXTENDED EXAMPLES	121
5.1 The <i>Crown</i> Example	122
5.1.1 The Squib for the <i>Crown</i> Case	133
5.1.2 Case Representation of <i>Crown</i>	134
5.1.3 Dimensional Analysis of <i>Crown</i>	139
5.1.4 Positioning <i>Crown</i>	141
5.1.5 Best Case Selection in <i>Crown</i>	144
5.1.6 Argument Records for <i>Crown</i>	146
5.1.7 Argument Outputs for <i>Crown</i>	151
5.2 The <i>Amezco</i> Example	162
5.2.1 Case Representation of <i>Amezco</i>	164
5.2.2 Dimensional Analysis of <i>Amezco</i> and Best Case Se- lection	170
5.2.3 Positioning <i>Amezco</i>	174
5.2.4 Argument Records for <i>Amezco</i>	175
5.2.5 Argument Outputs for <i>Amezco</i>	181
5.3 The <i>Structural Dynamics</i> Example	191
5.3.1 The Squib for <i>Structural Dynamics</i>	192
5.3.2 Positioning <i>Structural Dynamics</i>	193
5.3.3 Argument Outputs for <i>Structural Dynamics</i>	194
5.4 The <i>USM</i> Example	206
5.4.1 The Squib for the <i>USM</i> Case	207
5.4.2 Positioning <i>USM</i>	208
5.4.3 Argument Outputs for <i>USM</i>	209
6. THE CASE KNOWLEDGE BASE	219
6.1 Legal-Case-Frames	219
6.1.1 Top-Level Legal-Case-Frame	221
6.1.2 Underlying Legal-Case-Frames	222
6.2 Organization of the CKB	224

6.3	Figures	227
7.	A DIMENSIONAL INDEX	231
7.1	Dimensions Defined	231
7.2	Structure and Mechanics of Dimensions	233
7.2.1	Prerequisites	234
7.2.2	Comparing Cases Along a Dimension	236
7.2.3	Near-miss Dimensions	239
7.2.4	Citing Cases	241
7.2.5	Comparing Cases' On-Pointness	243
7.2.6	Modifying Cases	243
7.3	Relations among Claims and Dimensions	243
7.4	Advantages of Dimensions	245
7.5	Figures	248
8.	BASIC MECHANISMS OF CASE-BASED REASONING	254
8.1	Ordering Analogous Cases	257
8.2	Selecting Most Analogous Cases	260
8.3	Identifying Configurations of Counter-examples	264
8.4	Hypothetical Modifications to Explore Contingencies	267
8.4.1	Suggesting Interesting Hypotheticals to Pose	268
8.4.2	Heuristics for Generating Hypotheticals	269
8.5	Comparing Case-Based Analyses of Different Problem Situations	275
8.6	Figures	277
9.	CASE-BASED ARGUMENT IN HYPO	287
9.1	Roles Precedents Play in Making and Responding to Arguments by Analogy	287
9.2	Selecting Which Analogies to Draw	293
9.3	Explaining with Case-based Arguments	296

9.3.1	Explaining by Comparing	296
9.3.2	<i>Blue Book</i> Citations for Summarizing Precedential Support	297
9.4	Conclusion	299
9.5	Figures	301
10.	EVALUATING HYPO'S PERFORMANCE	310
10.1	Comparing HYPO's Points and Responses to Court Opin- ions	310
10.1.1	<i>USM Corp. v. Marson</i>	312
10.1.2	<i>Crown v. Kawneer</i>	315
10.1.3	<i>Amoco Production Co. v. Lindley</i>	317
10.1.4	<i>Structural Dynamics v. Engineering Mechanics</i>	320
10.2	Comparing HYPO's Citation Displays to Treatise Notes	322
10.3	Discussion	323
11.	IMPLEMENTATION OF HYPO	326
11.1	Programming Environment	326
11.2	Flavor System Modifications	327
12.	EXTENDING THE HYPO RESEARCH	330
12.1	Reasoning with Abstract Legal Predicates	330
12.2	Arguing by Analogy from Other Kinds of Claims	335
12.3	Connecting with Legal Databases	337
12.4	Learning Dimensions	338
13.	CONCLUSION	340
APPENDICES		
A.	EXCERPTS FROM OPINION	348
B.	EXCERPTS FROM PLAINTIFF'S BRIEF	351
C.	EXCERPTS FROM DEFENDANT'S BRIEF	353

D. UNIFORM TRADE SECRETS ACT	355
E. RESTATEMENT OF TORTS-SECTION 757	357
F. COMPLETE LIST OF LEGAL-CASE-FRAMES	359
G. CASES IN THE CASE KNOWLEDGE BASE	361
H. IMPLEMENTED DIMENSIONS IN HYPO	368
I. FACTUAL PREDICATES	372
J. GLOSSARY	375
BIBLIOGRAPHY	381

List of Figures

1	HYPO's Citation Summary for <i>Amexxco</i> Fact Situation	77
2	Excerpt from HYPO's 3-Ply Arguments for <i>Amexxco</i> Fact Situation . .	78
3	Excerpt from HYPO's 3-Ply Arguments for <i>Amexxco</i> Fact Situation . .	79
4	Excerpts from HYPO's Suggested Hypotheticals for <i>Amexxco</i> Fact Sit- uation	80
5	Legal-Case-Frames	84
6	Argument Evaluation Criteria	86
7	Basic Processing Loop	91
8	Case-Analysis-Record	96
9	Excerpts from Interpretation Frame	99
10	A Sample Claim-Lattice for the <i>Amexxco</i> Fact Situation	119
11	Argument-Record	120
12	Claim-Lattice for the <i>Crown</i> Example.	141
13	Overall Shape of Extended Claim-Lattice for the <i>Crown</i> Example. . . .	142
14	Detail of Extended Claim-Lattice for the <i>Crown</i> Example.	143
15	Claim-Lattice for Trade Secrets Claim in <i>Amexxco</i> Example	176
16	Claim-Lattice for Trade Secrets Claim in <i>Structural Dynamics</i> Example	195
17	Claim-Lattice for Trade Secrets Claim in <i>USM</i> Example	208
18	Top Level Case Frame for <i>USM Corp. v. Marson</i>	227
19	Case Frames for Parties in <i>USM Corp.</i>	228
20	Case Frame for Π 's Product in <i>USM</i>	229
21	Case Frame for Π 's Knowledge in <i>USM</i>	230
22	Case Frames for Δ 's Product in <i>USM</i>	230
23	The <i>Secrets-Disclosed-Outsiders</i> Dimension	248

24	The <i>Security-Measures</i> Dimension	249
25	The <i>Competitive-Advantage</i> Dimension	250
26	Excerpts from Case-Analysis-Record for <i>USM</i> Case	251
27	Excerpts from INTERP-FRAME for <i>USM</i> Case	252
28	Relations among Claims and Dimensions	253
29	Claim-Lattice for Trade Secrets Claim in <i>USM</i> Case	277
30	Extended Claim-Lattice for Trade Secrets Claim in <i>USM</i> Case	278
31	Most-On-Point Cases from Case-Analysis-Record for <i>USM</i> Case	279
32	Best-Cases-by-Claim from Case-Analysis-Record for <i>USM</i> Case	280
33	Claim-Lattice for Trade Secrets Claim in <i>Structural Dynamics</i> Case	281
34	Excerpts from Case-Analysis-Record for <i>Structural Dynamics</i> Case	282
35	Claim-Lattice for Trade Secrets Claim in <i>Crown</i> Case	283
36	Excerpt of Extended Claim-Lattice in <i>Crown</i>	283
37	Excerpts from Case-Analysis-Record for <i>Crown</i> Case	284
38	Hypothetical Variations of the <i>Crown</i> Case Suggested by HYPO	285
39	Extended Claim-Lattice for Trade Secrets Claim in Variant of <i>Crown</i> Case where Disclosures are Restricted	286
40	Citing Cases in an Argument: Citation Signals	297
41	Citation Signals in HYPO	298
42	Citing and Distinguishing <i>Data General</i> where CFS is the <i>Crown</i> Case	301
43	Citing and Distinguishing <i>Data General</i> where CFS is Hypothetical Variant of <i>Crown</i> Case with Disclosures Restricted	302
44	Citing and Distinguishing <i>Data General</i> where CFS is <i>USM</i> Case	303
45	<i>Data General</i> Cited as Boundary and Potentially More-On-Point Counter- Examples in Argument [1], <i>Crown</i> Extended Example	304
46	<i>Data General</i> Cited as Trumping and Boundary Counter-Examples in Argument [1], <i>Crown</i> Extended Example	305
47	<i>Data General</i> Cited as Target for Hypothetical Where a New Point Could Be Made. From <i>Crown</i> Extended Example	306

48	Citation Summary for <i>Data General</i> as Current Fact Situation	307
49	3-Ply Arguments about <i>Data General</i> as the CFS	308
50	3-Ply Arguments about <i>Data General</i> as the CFS	309
51	HYPO's Citation Summary for <i>Amoco</i>	319
52	Sample Compilation of Citations	325

CHAPTER 1

Introduction

1.1 Adversarial Reasoning

All of us reason adversarially. We tend to forget that because frequently there are no adversaries. No one takes the other side, challenging our approach and our conclusions. There may be no occasion for anyone to dispute us, or perhaps no one cares enough about the issue to bother, and sometimes we even forget to take the other side ourselves, internally, to challenge our own results. Or there may appear to be nothing to challenge. Our results may be consistent with common beliefs. No interest, economic or otherwise, would be served by a different outcome.

Nevertheless, all of us are called upon to be advocates, to make arguments to persuade others that we are right and that our position is reasonable, true or significant. Sometimes we do need to make arguments to defend our position against attack. Given sufficient motivation, some skeptic will always find a way to argue against what we consider to be true, to promote a contrary position, to disparage it as illogical or unimportant, or to carve an exception to it. More frequently, we are called upon to make arguments in explaining a position. An explanation is an argument in support of a position. Although the people to whom we explain may not be skeptics, they may be confused, inexperienced or simply unaware of a position's significance. An argument serves to illustrate and instruct but also to motivate them to believe that what we are saying is not only logically correct but important.

Adversarial reasoning goes beyond logical reasoning. In some domains it is simply not enough to justify a position by demonstrating a proof of a conclusion via a chain of logical inferences from general principles. It may not even be enough to refute a position by attacking various unstated assumptions or showing that the position leads to a logical contradiction. An adversary may do that, but that is only one style of argument which, even if possible in a domain, may not be dispositive. There are other ways of persuading people of the truth of a position that do not necessarily involve logic, for example, by drawing analogies to past experience. Indeed, in some domains, deductive reasoning hardly works at all. There are too few principles or the principles are inconsistent or their meanings are not well specified and yet, people in those domains make, win and lose reasonable arguments.

Even though the mechanisms of adversarial reasoning may differ, all domains have criteria for specifying a reasonable argument, specifically:

1. What counts as an appropriate justification in an argument;
2. How to counter a particular kind of justification;
3. How to combine multiple justifications into arguments;
4. What the criteria are for evaluating conflicting justifications and arguments.

It is essential for Artificial Intelligence research, in general, to examine specifically how positions are justified and evaluated in a domain because the structure and criteria of reasonable arguments are an important part of the domain's semantics. They supply domain-specific:

- Semantic contexts for propositions.
- Criteria for determining relevance.

- Structures of knowledge.
- Criteria for judging the level of expertise of an advice-giver.
- Criteria for judging the validity of specific advice.
- Criteria for learning and testing.

By supplying a context in which the propositions of a domain are used to explain, persuade or refute, arguments supplement the literal, definitional or logical meanings of propositions with another level of significance: their "force" in arguments. Reasoning about the dialectical meaning of propositions requires understanding the nature of reasonable arguments in a domain. Determining the relevance of information to an argument is also domain-specific and quite complex. Relevance can only be ascertained within the context of how the information can be used as a justification in an argument and how it effects the way an argument is evaluated. Similarly, explaining why the information is relevant can only be done in the context of its use in and effect on an argument.

The structure and criteria of reasonable arguments are also intimately related to how we judge the level of expertise of an advice-giver and whether we believe his advice. In any domain, an expert knows what a reasonable argument or counter-argument looks like and how to go about trying to mount one or defend against it. If the advice-giver does not know how to package his argument in the traditional garb, we conclude that he is no expert. We expect him to demonstrate fluency in making arguments, anticipating responses and preparing for contingencies. To the extent that we as recipients of advice are familiar with the criteria for evaluating arguments in the domain, we decide whether we are persuaded.

When we teach students in a domain, we teach them the structure of making reasonable arguments in that domain including the kinds of justifications that are acceptable and how to evaluate arguments. We commonly test a student's ability

to recognize, make, respond to and evaluate reasonable arguments. Machine learning thus has to reflect the entire structure of argument in a domain, including justifications, evaluation criteria, and strategies.

Having identified argument structures in a domain, AI gains an important tool for controlling inference by structuring knowledge to support argument-making. The ways in which knowledge is organized for making arguments are as domain-specific as the mechanisms and criteria of adversarial reasoning. For example, the kinds of bibliographic records and the indices that access data reflect the kinds of arguments that an expert practitioner needs to make in a domain, the kinds of information that are relevant for justifying those arguments and how the arguments will be evaluated. Just as bibliographies and indices vary widely from domain to domain, so will the knowledge structures that AI employs. There may be similarities and overlaps, but we will not know that until we have delved quite deeply into the specifics of argument-making in various domains.

1.2 Adversarial, Case-Based Reasoning

Adversarial reasoning often appeals to past experience. One kind of adversarial reasoning that does show promise of generality is arguing by drawing analogies to prior cases.

This dissertation is about adversarial, case-based reasoning and a program, **HYPO**, which models adversarial reasoning with cases and hypotheticals in a legal domain. The research extends Artificial Intelligence into domains where there are no "right" answers, no internally consistent and well-defined theories for making and explaining decisions but only arguments in favor of alternative possible conclusions based on the experience of prior cases. In these domains, where experts do not agree what the rules are or what they mean, where reasoning

is not all *modus ponens*, and explanations are not just restating ones conclusion in more general terms, arguing with cases and hypotheticals is the methodology of choice.

The adversarial, case-based reasoning process involves making arguments in favor of a decision by citing analogous prior cases as justifications. It involves a cluster of phenomena, including:

1. Comparing a problem situation to a past case to justify by analogy the conclusion that the same decision should be reached.
2. Distinguishing the problem situation from a past case to justify the conclusion that it should *not* be decided analogously.
3. Arguing that a particular case does not provide a compelling justification for deciding the problem situation by comparing it to counter-examples, cases just as similar to the problem situation but where different outcomes were reached.
4. Posing hypothetical cases as examples and counter-examples where the purported comparisons or distinctions would or would not justify the desired result.
5. Combining comparisons to and contrasts with many cases into an argument how the problem situation should be decided and evaluating the strength of the competing arguments.

The chief advantages of adversarial, case-based reasoning are that it facilitates decision-making in domains that lack strong theoretical models and, by employing indexing to deal with the problem of controlling inference, enables a wide range of explanation, persuasion, and strategic planning techniques not currently well understood in AI. Even in domains where there is consensus about the rules

and what they mean, we expect experts to argue with cases. It is one thing for an expert to analyze a problem situation and another for him to persuade us that the analysis is correct by critically comparing the situation to previous cases, explaining the significant differences and posing hypothetical cases to demonstrate potential problems. If a human expert could perform only the former task, we might well doubt his level of expertise. Critically comparing a situation to other cases – arguing why they are the same or crucially different – is an important component of explaining, persuading and planning.

1.3 Adversarial, Case-Based Reasoning in the Law

Legal argument is a paradigm of adversarial, case-based reasoning. In law, attorneys *justify* an analysis or argument by citing and reasoning about precedent cases. To justify an assertion that a client should win in a particular fact situation, attorneys draw analogies to prior cases where similarly situated parties won. They distinguish away troublesome cases that would lead to contrary conclusions by pointing out the legally important dissimilarities. Even when attorneys cite constitutional or statutory provisions in support of their conclusions, they almost always prefer also to cite cases in which courts have applied the provisions in similar circumstances.

To the outsider, legal decision-making may seem arbitrary and chaotic, but, with its emphasis on case precedent, the law is an organized chaos. See [Levi, 1949]. Of course, arguing from precedents is formally ensconced in Anglo-American law in the rule of *stare decisis*¹ but, in practice, attorneys also routinely employ

¹The rule followed in Common Law jurisdictions that “a holding by a court in a previous case is binding on the same court (or on an inferior court) in a similar case.” [Berman & Greiner, 1980].

prior cases as justifications for decisions in strategic planning of lawsuits, legal arguments and commercial transactions, as well as in drafting briefs and opinions.

Lawyers have no choice but to argue from cases. Although the law has many general rules and many specific fact situations, it lacks intermediate rules that define the predicates and link the general rules to the specific fact situations. Lacking definitions, courts and advocates, who must decide whether a general rule of law applies to a specific dispute, cannot settle the matter by logical deduction. Instead they argue analogically that a rule of law applies to a dispute by comparing it to similar prior cases where a court held that the rule applied. One side argues the similarities; the opposing side argues the differences and draws analogies to other cases more favorable to its position.

AI attempts at modelling legal reasoning should be judged, consequently, in terms of the extent to which they capture the above aspects of legal reasoning, specifically whether they:

1. **Model Adversarial Reasoning:** In law, there seldom is one right answer but usually several reasonable arguments on all sides of an issue. The reasonable but rejected arguments are as essential to understanding and explaining a decision as the argument ultimately followed. It follows that an AI program must make and evaluate alternative arguments.
2. **Model Case-Based Reasoning:** In most legal fields, including statutory domains, citing cases are the preferred means of justifying positions in an argument. Reference to specific cases, real or hypothetical, are the only way in law of ascribing a meaning to general legal rules.
3. **Employ Rules as Guides:** If legal rules are represented, they cannot be treated as allowing the reasoner to deduce "the answer" to a legal problem. That is not the way legal rules are used. The primary role of legal rules is as guides to cases that interpret them, some of which may involve relevantly

similar fact situations from which convincing arguments by analogy can be made. Any program that treats legal rules as driving a deductive inference engine necessarily ignores a fact of legal life, that legal rules are neither consistent nor complete. The rules are contradictory and the predicates are not well defined.

4. **Spot Issues:** The program needs to spot those potential issues that convey an adversarial advantage to one side or other in the legal dispute. This is not simply a matter of determining when a fact situation presents a “hard” or “easy” question, but whether and what arguments can be made on either side of the question and which side has the stronger argument.
5. **Pose Hypotheticals:** In order to evaluate and plan arguments, the program needs to be able to pose hypotheticals to demonstrate contingencies that could affect the outcome of the argument, suggesting new arguments to make or defend against.

1.4 Chapter Guide to Dissertation

As a guide to the reader, here is a summary of the chapters of the dissertation by topics and importance.

Chapters 4 and 5 are the core chapters of the dissertation providing an overview of the HYPO program and a variety of examples of how it works. Chapter 4 presents HYPO’s knowledge sources, reasoning process, architecture, modules, major algorithms and data structures. Chapter 5 works through four extended examples of HYPO’s reasoning process from start to finish, illustrating the inputs to and outputs from the process and providing a running commentary of the steps.

Chapter 10 presents an evaluation of HYPO's performance in the examples of Chapter 5 by comparing the outputs to the arguments that lawyers and judges made in the actual legal cases on which the example fact situations were based.

Chapter 12 provides some specific suggestions for extending HYPO's reasoning process to account for more sophisticated kinds of precedential reasoning including arguing about the meanings of abstract legal predicates.

Chapters 6, 7, 8 and 9 provide a more discursive account of selected aspects of HYPO's function and design. HYPO's two languages for representing legal cases and their facts, legal-case-frames and factual predicates, its Case Knowledge Base ("CKB") of actual legal cases and the Dimensional Index to the CKB are discussed in Chapters 6 and 7. Chapter 8 identifies basic operations of Case-Based Reasoning and how they are performed in HYPO including comparing cases, selecting the most analogous cases and posing hypotheticals. HYPO's use of claim-lattices in selecting most analogous cases and identifying configurations of counter-examples is discussed in detail. The purpose of the case comparisons and hypothetical modifications is to generate arguments. Chapter 9 discusses how HYPO's 3-ply arguments and hypotheticals take advantage of HYPO's ability to interpret precedents dynamically in light of the particular facts of the problem situation and the argument context.

Chapters 2 and 3 set the scene by describing adversarial, case-based reasoning and its uses in the legal domain. In Chapter 2, we present a model of the adversarial, case-based reasoning process, discuss its advantages as well as the problems of computationally implementing it, and compare in a general way, the approach taken in this dissertation in designing HYPO with that of various lines of research in Artificial Intelligence, including argument discourse analysis, analogical, case-based and example-based reasoning, explanation and AI models of legal reasoning.

Chapter 3 illustrates the crucial role of adversarial, case-based reasoning in legal argument by presenting a true-to-life legal problem. We also illustrate the roles of hypotheticals in legal argument with some exchanges from actual oral arguments before the United States Supreme Court and take a brief look at the views of analogical legal reasoning taken in the jurisprudential literature.

Chapter 11 presents some lower level details about the implementation of HYPO including a description of the programming environment and run times.

As the above summary suggests, there are a number of paths through the dissertation depending on the reader's interests:

1. For the reader who wants to learn the most about the HYPO program as quickly as possible, the suggested path: is Chapters 4, 5, 10, and 12.
2. Additional information about selected aspects of HYPO's design are contained in Chapters 6, 7, 8 and 9.
3. The Do-it-yourself'er will find the most useful information in Chapters 4, 5 and 11.
4. The reader interested in the dissertation as a disquisition on adversarial, case-based reasoning, generally and in law, should focus on Chapters 2, 3, 4, 8, 9, and 12.
5. Lawyers would probably find the following path to be the most accessible: Skim Chapter 2 focussing on Section 2.5.6. Then read Chapters 3, 4, 5, 9, 10 and 12.

CHAPTER 2

Adversarial Reasoning with Cases

In this chapter, we focus on *adversarial* reasoning. We begin with a garden variety example of adversarial reasoning to illustrate making and responding to argument points by drawing analogies to, and distinguishing, prior cases. We examine a model of a case-based, adversarial reasoning process, discuss some of the advantages of this kind of reasoning, and the choices and problems encountered in computationally implementing the process. We conclude by showing how aspects of these problems have been dealt with in various lines of research in artificial intelligence including argument discourse analysis, analogical, case-based and example-based reasoning, explanation and AI models of legal reasoning.

2.1 Adversarial Reasoning with Cases – A Prosaic Example

All of us reason adversarially with cases everyday. Consider a prosaic example:

A twelve year old, whose birthday is next month, argues with his over-protective parents because they will not allow him to go to the movies to see “Little Shop of Horrors”. He cogently urges that it’s not fair that his parents will not let him go when they have allowed his fifteen year old sister to go. His parents’ short answer to little brother’s analogy, as if it were enough, is “Your sister can go because she is three

years older than you are.” In rebuttal, he asks – or rather, he demands to know – “Why does *that* make any difference?”, a question to which his parents have many dubious responses, among them: “Your sister is more mature than you are.”; “The movie gets out too late – it’s past your bedtime.”; “The movie is rated PG-13 – it’s for teenagers.”... , to which there are at least as many indubitable retorts: “But I *am* a teenager! I’m going to be 13 next month.”; or “I could see it on a VCR but not at the movies!”; or “Noah’s parents let *him* go see it.” Dubious as the responses are, there are plenty of other differences that meet the issue even less: “Your sister is a girl and you’re a boy.”; “Your sister has more money than you do.” (One can imagine the issues for which *these* distinctions would make a difference.); and some differences that appear to favor the opposite conclusion: “Your sister has more homework than you do.”

Little brother shows a certain aptitude for lawyering. At least his argument shows some of the hallmarks of a legal argument¹:

1. Much of the dispute centers around the applicability of rules whose predicates are not well-defined. The meaning of even a common term like “teenager” in the PG-13 rule depends on the context. Sometimes it means “ ≥ 13 ” but sometimes it may also mean “of the level of maturity of at least an average 13 year old.”
2. One of the ways of arguing about ill-defined predicates is to cite similar cases where the rule applied – or where the rule did not apply but should have if it really meant what the opponent says it means – as part of a justification for applying or not applying the rule to the case at issue. As the boy’s impassioned plea, “I am a teenager!”, in effect, points out, if he’s not a teenager then neither is Noah, but that did not prevent Noah from seeing the show.

¹Most adolescent arguments do.

3. Even where the dispute is not about a particular rule or predicate it is often persuasive to cite a similar prior case as a *justification* for doing the same thing in a new case, a justification that needs to be honored, if only in the breach, by giving a reason for not following it. Little brothers making the fairness argument often cite their big sisters as similar cases, at least for that purpose.
4. The arguers share expectations about how to interpret the case-based arguments. In particular, they expect that: (a) the poser would like his own case " α " to be treated in the same way as the posed analogous case " β " was treated (i.e., little brother wants to go to the movies, too); (b) there are some particular similarities between α and β ; and (c) that those similarities *justify*, or at least purport to justify, treating the two cases in the same way. The common interpretation guides common ways of responding to the argument.
5. There usually is an argument about the existence or significance of the purported similarities. Implicitly, the parents' response denies that the implied assertion that common origin of sister and brother justifies allowing the latter to go to this movie.
6. Being able to spell out why two cases are relevantly different is just as important as being able to tell why they are similar. In distinguishing the allegedly similar case, the arguers point out what is different about the two cases and why that difference justifies not treating the cases the same way. For example, the parents try to distinguish the brother's case from the sister's. They point out factual differences, in the childrens' ages, maturity and bedtimes, as well as theoretical justifications why the differences matter, ranging from the invocation of a simple rule that a movie should only be seen by the age group for which it is rated to an implied, complex theory about certain movies requiring maturity and the relation of childrens' ages

to maturity. Note how the dialectical need to distinguish drives the distinguisher both to investigate for new differences and to find or create theories that assign the desired significance to the differences. The factual difference and the theoretical justification are, of course, intimately related. The sex difference, for example, may not appear relevant except, arguably, in light of the maturity theory and the generalization that girls mature faster than boys.

7. Another way to respond to the allegedly similar case is to cite a counter-example – real or hypothetical. For example, the parents might say, “If we had known that your sister was going to see *that* particular movie, we would never have given our permission.”
8. Distinguishing and citing counter-examples usually are not the last words. In rebuttal, an arguer may:
 - (a) Grant the difference but show that it actually leads to the opposite conclusion from that of the distinguisher. For example, the supposed difference in maturity may imply that the sister has greater responsibility – like homework – and drive a factual query whether sister does not have a big report due tomorrow and shouldn’t be going to the movies after all. The asserted distinction backfires and actually hurts the distinguisher’s position; or
 - (b) Distinguish the counter-example. One can almost hear the parent’s next response: “Just because Noah’s parents allow him to do certain things does not mean ...”);
 - (c) Cite a counter-example to the counter-example. (e.g., the parents might note that the Cleavers did not allow their twelve-year old to see the movie.)

9. Case-based arguments can be won or lost. The arguers also share expectations about how to evaluate the persuasive strength of an argument citing precedents. An arguer strengthens his position to the extent that it:
 - (a) Cites cases that had favorable outcomes and are the most analogous to the facts at issue (i.e., are the least distinguishable.)
 - (b) Cites cases for which there are no more analogous counter-examples.
 - (c) Cites more of these most analogous cases without counter-examples than his opponent.
10. Case-based arguments present strategic choices:
 - (a) If possible, sometimes its better to avoid being drawn into an argument citing cases. Although the parents might have responded simply by saying, "So what? What your sister does is none of your business.", by bothering to distinguish the case cited by their son, the parents, in a sense, buy into the game.
 - (b) Leading off with a case for which the opponent can cite numerous equally analogous counter examples puts one on the defensive. It would have been better not to cite the case.
 - (c) Asserting a distinction that can be turned against your position – like the homework argument – makes the arguer and his argument look foolish and inconsistent.
11. Case-based arguments may turn on issues that, in a sense, are orthogonal to the real merits of the dispute, such as how many and how good are the cases that a side cites. The Cleavers may simply be *the* authorities on parenting in this neighborhood.
12. By posing analogous precedents, the arguers make their points efficiently and succinctly. Little brother's opening shot puts his case rather neatly.

Think how complicated an argument it is to spell out! There may be any number of theoretical justifications on which he could rely – assuming he could think of any at all – some innate universal principle of family life that all siblings are created equal or manly conviction that he can handle any grossness that Big Sister can stomach. Using analogies, the arguers do not even need to express what the justifications are much less agree on them or their validity. If a participant in an argument by analogy *does* spell out his justification, however, his opponent can take issue with the justification, as well as try to distinguish the posed case.

2.2 An Adversarial, Case-Based Reasoning Process

In various domains, more sophisticated, stylized, and constrained versions of the same kind of adversarial, case-based reasoning illustrated above are actually used in the decision-making process. Arguments citing analogous prior cases – or precedents – as justifications are made for and against deciding a problem situation in a reasoning process that has the following steps:

1. The new fact situation is analyzed by comparing it to relevant prior cases or precedents.
2. Each precedent is used as the basis of a justification that the new case should be treated in the same way as the precedent. The justification is made by drawing the analogy between the new case and the precedent by focussing on their important similarities. In addition, the differences between the new case and the precedent are used as the basis of a justification why the new case should *not* be treated like a given precedent.

3. Since there may be many relevant precedents, some of which may lead to conflicting results, one makes the strongest arguments on all sides of the issue of how to decide the case. The arguments are generated by combining the justifications for treating the new case like various precedents with the justifications for not treating it like the conflicting precedents.
4. A decision is made by evaluating the competing arguments, and where possible, selecting the strongest.
5. The decision is explained in terms of the supporting argument by discussing the case precedents relied upon and distinguishing the alternative precedents.

In the adversarial, case-based reasoning process, the fact that the problem situation shares a certain cluster of important features with a precedent is deemed to justify coming to the same conclusion as in the precedent. The precedents:

1. Identify the features – the similarities and differences – that are important in making a decision about the problem situation.
2. Identify the outcome[s] that those similarities and differences favor.
3. Provide a basis for resolving conflicts where different features favor conflicting results. A precedent with the same conflicting features is a justification for resolving the conflict in the problem situation in the same way it was resolved in the precedent.

To perform the reasoning process it is essential to have criteria for evaluating precedent-citing arguments and methods for comparing competing arguments. The evaluation criteria may leave the decision-making process under-determined in any given problem situation.

In adversarial, case-based reasoning, there may be, and often is, no one right answer. If the emerging precedents all favor one decision, then the decision is clear. If the precedents lead to conflicting conclusions, however, then the case-based reasoner critically compares them, for example, by distinguishing them, that is, finding factual differences between them and the new case that justify treating them differently, or by determining hypothetically the effect that deciding the new case according to one precedent would have on other well-entrenched precedents. The evaluation criteria at least allow the reasoner to identify the most persuasive competing alternatives.

Even where the evaluation criteria do yield the strongest precedent-based argument for deciding the problem situation, the selection does not imply that the alternative arguments are wrong in the sense of logically false, simply that in light of prior case experience, they are less persuasive.

2.3 Advantages of Adversarial, Case-Based Reasoning

The chief advantages of adversarial, case-based reasoning are that it:

1. Facilitates decision-making in domains that do not have strong models.
2. Allows alternative plausible decisions to be generated with a minimum of inferencing.
3. Enables a wide range of explanation, persuasion, and strategic planning tools that supplement other techniques.

Adversarial, case-based reasoning may be the only kind that works in domains that do not have strong model. A domain does not have a strong model if:

- It lacks any theory from which to deduce an answer to the problem situation.
- Although it has such a theory, the theory is partial in the sense that the predicates of the theory are not well enough defined to deduce whether they apply to the problem situation or not. This is the problem of *open textured* predicates. In many domains, at some level of grain size, the predicates are not or cannot be further defined in terms of rule-like definitions. There may be little consensus about what those definitions should be, the range of novel fact situations the definitions have to encompass may simply be too great or unpredictable, or there may be strong institutional reasons for leaving the predicates ambiguous.
- There are many, competing theories, some of which lead to conflicting conclusions about the problem situation. There may be a number of authoritative experts who profess different, possibly conflicting partial theories about a domain or a class of problems.

In domains lacking strong models, experts reason about problem situations by arguing their similarities to and differences from prior cases. Adversarial, case-based reasoning plays an important role in such diverse domains as law [Levi, 1949], historical political analysis [Neustadt and May, 1986; Alker Jr. and Christensen, 1972], philosophical investigation, strategic planning, medicine, market analysis and real-estate appraisal.

Even in domains with strong causal theories like mathematics or scientific inquiry (where the primary mode of justifying a conclusion is through the methods of logical inference) experts pose real and hypothetical cases as counter-examples to test and modify hypotheses. See [Kuhn, 1970; Lakatos, 1976].

Case-based approaches also allow experts to scope out a range of plausible decisions or to come to quick estimates by comparing the problem situation to prior cases, without doing the detailed analysis that applying the theory entails.

Their may be a microeconomic theory for determining the market price of a 3 bedroom home in Amherst, Massachusetts but for ease of estimate – and in this example, for accuracy, too – there is no substitute for comparing the home to other recent sales on the block. The comparison may involve estimating by extrapolation, for example, adding or subtracting a few thousands to make up for the fact that the most recent sale on the block was three months ago or had only one bathroom or was on the sunnier side of the street. Prior cases can even give one a handle on how to evaluate the differences. If one can find two previously sold houses that were the same but for the number of bathrooms, that is a way of determining how much the extra bathroom is worth. The problem is finding comparable houses that differ only in that respect.

For any domain, case-based approaches are important for explaining, persuading and planning. We expect experts to be able to:

1. Explain their analysis of a situation by giving examples.
2. Pose hypotheticals to demonstrate the critical features, which if different, would have lead to a different conclusion.
3. Persuade us to believe the conclusion by:
 - (a) Comparing the current situation approvingly to previous cases.
 - (b) Extrapolating from less-similar cases (e.g., by pointing out differentiating features of the cfs that warrant the desired conclusion even more strongly).
 - (c) Posing hypotheticals to illustrate the dire consequences if the proposed conclusion is not adopted.
4. Plan for contingencies by posing hypothetical scenarios (worst, best, most recent, most likely cases, etc.) that illustrate the consequences of and alternatives to a given course of action.

In generating a skeletal argument of justifications based on precedents, a case-based reasoner provides a framework for performing these tasks. Comparisons to other examples make good explanations. A case-based reasoner explains its analyses by citing the precedent cases as examples. The reasoning process generates a range of alternative answers based on different precedents. By comparing and distinguishing the cases, the reasoner lays out the comparative strengths and weaknesses of the alternatives. The alternative cases also suggest the hypothetical variations of the problem situation that might be decided differently if critical facts are changed. A case-based reasoner's ability to illustrate the consequences of and alternatives to a given course of action by posing hypothetical scenarios is vital for strategic planning of an argument.

2.4 Problems for Computationally Implementing Adversarial, Case-Based Reasoning

The biggest problem for computationally implementing adversarial case-based reasoning is controlling the amount of inference necessary to compare and contrast cases. Given a new case α , in order to find β 's, cases with relevantly similar features that justify a desired result and that can be used in an argument for coming to the same result in α , the program, in effect, has to search through the three spaces at once, a space of:

1. Relevant precedents,
2. Possible justifications based on the precedents, and
3. Possible arguments combining the justifications.

The three searches interact. The strength of any one precedential justification depends on how the cited precedent compares with all the other precedents

that could be cited and that depends on comparing the precedents to each other relative to the facts of the problem situation. The strength of any one argument depends on the ensemble of justifications that can be made in its support as compared to those that can be made in support of some alternative argument.

Given a problem situation α , finding or generating relevant cases, β 's, with which to make or respond to arguments in favor of a position, and selecting from among them the best β 's to cite, are computational problems of potentially great complexity. For any given β , there are many possible ways of comparing it to α . Not all of them are relevant argument justifications for treating the cases the same or differently. The relevance of even a crucial difference may not become apparent except after a possibly long chain of inferencing, and it may "cut" the wrong way, that is, lead to a chain of inferences that hurts, rather than helps, the distinguisher's position. There may also be many possible theories that would lead to the conclusion that α and β should be treated differently. Which one should the system try? How far should it backchain before deciding that there is no crucial difference between α and β along the lines of that theory? For example, in distinguishing, the parents need a theory whose pre-ordained conclusion – that their son shall not go to the movie – ought to apply to β but not, because of some factual difference, to α . Thus, they invoke the rule that PG-13 movies are only for teenagers, a rule that, because of the age difference, admits only one of the children. In either case, the similarity or difference is crucial but only in light of the justification, that is, the chain of inferences derived from the theory. The problem is, *how does a system find the factual comparison and the theoretical chain of inferences?*

Indexing is the key to computationally implementing this complex kind of search on anything approaching a realistic scale. The index must relate features of cases with their uses as justifications in arguments and facilitate comparing the cases easily. The index enables the program to identify which of the possible

factual comparisons make a difference in terms of justifications for treating cases analogously, how those similarities and differences tie in to the justifications, what outcomes they tend to support and how to assess the strength of the combined justifications.

Even with an index there are problems of complexity. The issue is how much should the system have to analyze α to access the index to find β s? To what extent should it look at:

- Only surface level facts of the cases? If only surface level facts, which ones?
- Facts and relationships inferable from surface level facts?
- The reasoning process used, or espoused by the deciders of those cases?

Where the number of features of cases that are represented is large, and the possible inferences from the features great, the "depth of inference" needed to access the index should be kept shallow. **Depth of inference** means the difference between the level at which a case is described and the level of description of the index entries in light of the possible alternative inferences that could be drawn from the description of the case. It is meant as a rough, qualitative measure of how much inference a program has to perform to match a case to an index.

In essence, a case-based implementation of arguing by analogy controls the inferencing problem by flattening out the depth of inferencing needed to come up with precedential justifications. The similarities and differences among cases that are important in the domain are:

- factual similarities and differences – those describable in nearly the same terms as are employed to state the facts of the case – that
- previous cases have indicated are important.

They are predefined for the system and used as entries in the index of cases. Each entry is supplemented with information about what outcome the associated features favor and how the features could be changed in magnitude to strengthen or weaken their support for that outcome, information used to make comparisons of the cases.

Where appropriately selected surface-level features of variable magnitude, tagged by the outcomes they favor, are used to index cases:

- Finding relevant cases is a matter of analyzing the problem situation to determine the combination of features presented by it and retrieving cases indexed by those features.
- Selecting the best precedents is largely a matter of selecting the cases with the greatest overlap of indexing features relative to the problem situation.
- Generating novel cases to use in hypothetical reasoning is accomplished by adding, subtracting and changing the magnitudes of indexing features relative to the best precedents.
- Arguing with cases involves comparing the competing best precedents among themselves relative to the problem situation in terms of shared and unshared indexing features and differences in magnitude.²

²The problem of controlling inferencing comes up in another context, *explaining* the reasoning. It is not enough for a program to compare cases, it must also be able to explain the comparison in terms of the similarities, differences and justifications. To get a sense of how complicated a process this might be, consider what explaining a comparison of cases would mean in the MYCIN paradigm. Any comparisons would have to be of the results of running the program on each case separately. Comparing the explanations, consisting basically of the trace of inferences augmented with certainty factors and, possibly, references to the goals served by selected inferences in the chain [Clancey, 1983] would require a tedious exegesis.

The approach to dealing with the inference control problem outlined above is the one adopted for the HYPO program, the subject of this dissertation research. Although the depth of inference is shallow, the depth of analysis is not by virtue of the breadth of the index, the size and diversity of the knowledge base of cases, and the schemes for selecting best cases to use as precedents, comparing cases and hypothetically modifying them. And, as we will see, the implementation can be extended to account for deeper, more abstract reasoning about the problem situation with cases.

To read more about the domain of legal argument, the domain in which HYPO performs adversarial, case-based reasoning, the reader may wish to turn to Chapter 3. The reader who wants to learn more about how the HYPO program works may skip to Chapter 4.

2.5 Related Research

To set the stage for the discussion of the HYPO program and the nature of the case-based legal arguments it produces, in the remainder of this chapter, we will examine a number of lines of research in areas of artificial intelligence that bear in some way on the theoretical and practical aspects of adversarial, case-based reasoning. We summarize the relevant contributions in these areas, including argument discourse, analogical reasoning, case-based and example-based reasoning, explanation and AI models of legal reasoning, and, where possible, compare and contrast the general approach taken in the design of the HYPO program.

2.5.1 Argument Discourse

Researchers in argument discourse have focussed on the problem of reducing undirected inferencing in connection with argument understanding and planning argument responses.

McGuire, Birnbaum and Flowers have described various ways of coordinating knowledge of the domain, of how to reason and of how to argue in an attempt to reduce undirected inferencing in the tasks of understanding arguments and planning argument responses. They correctly distinguish between the explicit content of a proposition and its force in terms of the argument. They use "argument graphs" to represent the relationships of support and attack among the individual propositions of an argument and have identified patterns of support and attack relations in arguments, such as the "stand-off" argument molecule and the "contrastive positions" structure, that, once recognized, guide generating responses [McGuire *et al.*, 1981; Birnbaum, 1982]. The structures assign argument roles to the various component propositions and lay out rebuttal options so that the reasoning system can select which propositions in the structure need to be, or safely can be, supported or attacked. For example, the system can decide to avoid:

- Using a tactic, like attacking the main point, that it has already tried,
- Trying to attack evidence if the evidence was previously verified,
- Hurting its own position as it would if, having identified a stand-off, it stuck to its claim.

In addition to identifying structures in argument that are useful in directing inferencing, McGuire, Birnbaum and Flowers maintain that memory (a term that we will use to include the organization of the data base) should be designed to

support the higher level argument structures. The authors propose to use the structures, for example, to generate rebuttals to arguments, like citing counter examples, on the fly as a by-product of the "understanding" process [McGuire *et al.*, 1981]. Unfortunately, it is not at all clear that their specific memory organization (about which the authors are somewhat vague) is strong enough to support adversarial reasoning in a robust manner. Although they speak of storing "expectation failures" in memory as hints for subsequently generating counter-examples on the fly [Flowers *et al.*, 1982], they do not explain how inferential memory is informed about the goals of the arguer so that it realizes that any evidence it uncovers which contradicts a particular position will be useful as a counterexample and should be saved. One would expect that as there are more and more senses in which expectations fail from differing points of view, memory would become mired in complexity. Moreover, the selection among response options is more complex than the authors allow. Choosing to attack a point of evidence may have undesirable repercussions on other aspects of a party's argument not represented in the local pattern of support and attack relations represented by a single argument molecule. One needs a more comprehensive model of the overall effects of possible argument moves in order to make more global strategic choices.

Cohen's computational model of argument, with its interesting representation of arguments as trees in which claims are fathers to evidential propositions, also shows the utility of tracking support relations [Cohen, 1983]. She wisely focuses on the different kinds of evidential support relations between propositions and a claim in an argument including inductive inference and the "partial" support provided by examples and counter-examples. Her main definition of an evidential relationship, however, namely the existence of logical inference chains, is much too fine grained for any hope of effectively controlling inferencing even with her reliance on a collection of semantic, syntactic and pragmatic methods like the use of inferencing frames to cope with missing information and with common

erroneous inference rules.

By contrast, [Reichman-Adar, 1984] emphasizes the use of much larger scale structures to guide inferencing in the task of understanding argument discourse (larger scale even than those proposed by McGuire, Birnbaum and Flowers). Reichman-Adar presents a tantalizingly rich but non-operational computational model of natural language discourses in which context spaces are used to represent the topics of *groups of propositions*, and the roles those groups play in a dialog. A conversation is viewed as a series of conversational moves, each of which corresponds to a particular functional relation between the utterances generated and those of a preceding context space. The moves may be to present, explain, support and challenge claims, shift topics or resume a suspended discourse. The moves have preconditions and effects. They set up expectations in the system about what appropriate conversation moves may follow (e.g. expectations include resuming a context space, returning to what initiated an analogy, further-challenging a claim or counter challenging a challenge) and how ensuing statements should be interpreted. The moves thus assist in focusing an inference mechanism or an understanding module. By keeping track of items in focus in particular context spaces, the program theoretically can resolve ambiguous references and determine relevance.

Reichman-Adar, too, recognizes the variety of support and attack relations possible in an adversarial discourse. For example, she describes the process of using an analogy in an argument to support a general principle common to the target and analogous situations [Reichman-Adar, 1984]. She leaves a slot for a mapping between features of the target and goal and allows for attacking an analogy by criticizing the mapping or showing that a principle applies to the analogy that undermines application of the target's principle to it. Unfortunately, although Reichman-Adar's "system" is a fecund source of ideas, it also is an example of elaborating knowledge representation schemes without clearly

delineating the tasks they are supposed to perform. In the absence of a working system, one cannot judge the efficacy of the finer distinctions among her context spaces.

In summary, the argument discourse research provides the following insights:

1. Propositions should be seen in the light of the roles they play in an argument and their "meanings" should be expanded to include their force in an argument.
2. Arguments can be schematized in terms of support and attack relations among their components.
3. There are many kinds of support and attack relations among propositions in an argument beside those that involve logical chains of inference;
4. Larger scale structures in arguments can be identified that elucidate these support and attack relations and that can be used to guide inferencing;
5. Memory should be organized to accommodate the larger scale structures.

In general, the argument discourse researchers have not gone far enough in organizing data base or memory structures that will support realistic argument-making in a particular domain. They do not identify crucial domain-specific knowledge such as:

- What constitute acceptable justifications in an argument.
- Detailed models of support and attack relations among the justifications.
- Criteria for evaluating competing arguments.

Thus, the memory structures that they propose will not generate realistic arguments in the domain. By contrast, HYPO's model of the support and attack relations among precedents – 3-Ply arguments consisting of points, responses, and rebuttals where responses distinguish and cite various kinds of counter-examples to the cases cited in points – allows it to make realistic decisions about the strength of competing arguments and the choice of which arguments to make.

Nor are the argument researchers' inference mechanisms computationally tractable. Most rely on *modus ponens*. Some, like [McGuire *et al.*, 1981] speak of generating counter-examples on the fly, but do not tell us how the indexing schemes would work as the number and complexity of past experiences increase.

Stronger, more domain-specific memory structures are required to deal with the problem of controlling inference. Computationally implementing argument requires organizing the knowledge in a way that reflects the criteria for making and evaluating arguments in the specific area of expertise. Where examples and counter-examples are going to be used in argument, they will have to be filed in indices that reflect their dialectical significance.

Researchers should take their cues from the specific bibliographic tools and indices employed by experts in the domain. For example, in essence, a legal library is a compilation of past cases indexed especially for use in making arguments. The real-life bibliographic indices and source materials in the law organize the cases for retrieval in terms of how they can be used to support or attack positions in legal arguments about various stereotypical fact situations. HYPO's organization of cases mimics the bibliographic tools of the legal domain while, at the same time, improving their ease and speed of application.

Once a system is developed that has a robust capability for case-based inference, models of argument discourse could be *implemented* as well as just described. A case-based reasoner could drive a working discourse program that argues about

legal cases. The program's control mechanism could plan the construction of arguments and counter-arguments in the light of its case-based inferences about who has the stronger argument. Reichman-Adar's model of discourse moves, like flat-denial, *modus ponens* or analogy, would, of course, be relevant, but the expectations of arguers who make and respond to case-based points would also be explicitly represented so as to guide the choice and application of the moves. See also [Perelman, 1982; Toulmin, 1958].

2.5.2 Analogical Reasoning

The approach taken in HYPO differs from that of other AI research in analogical reasoning in a number of respects. HYPO:

1. Performs a highly constrained kind of matching.
2. Does not use a static hierarchy among features.
3. Does not assume a strong model of the domain.
4. Combines information from the most analogous cases.
5. Symbollically compares the most analogous cases and counter-examples.

AI systems differ in the kinds of matching they perform. At one extreme is the simple matching performed by the program described in [Winston, 1980]. In trying to decide if a problem situation is analogous to a target situation, the program attempts to place the parts of the situations into correspondence by matching up the objects, their classes and properties and the relations among objects. Points are scored for successful matches. The match with the highest total points is deemed to indicate an analogous base situation [Winston, 1980, pages 693-697]. As the fact situations become more complex, the combinatorics

of the matching scheme become unworkable. In order to reduce the number of possible matches that need to be considered, some relations, those that involve causation and temporal relations, are considered to be more important; other relations among the objects are ignored [Winston, 1980, pages 695–696]. Other efforts to deal with the combinatorics of the matching process by imposing general constraints are those of Gentner, Holyoak and Thagard. Their work focuses on identifying general constraints on matching descriptions of analogs involving predicates and constants. [Gentner, 1983] employs syntactic criteria involving the order of relations of the features to be matched. [Holyoak and Thagard, 1987] identifies five constraints involving logical kind, uniqueness, sameness of relations, similar meanings and role identity.

At the other extreme in terms of kind of matching performed are the problem solving programs described in [Carbonell, 1982; Carbonell, 1983a; Carbonell, 1983c]. A key component of this approach is to examine the underlying structure of past solutions to problems which can be thought of as proofs, plans or justifications for the results. In “transformational” analogy, solutions to previous problems are indexed according to goals achieved; they are retrieved for use as target models for solving a new problem. Operators like insertion, deletion, splicing-in and reordering are used to transform the targeted past solutions into a solution of the new problem. The transformational approach floundered on the obstacle of recognizing analogous problems despite apparent differences in the language or levels of abstraction used to represent the problems and the solutions. In the subsequent work on “derivational” analogy, one examines the reasoning that resulted in a prior solution as well as the solution. Successful and unsuccessful solution paths, and the reasons why the paths were taken or aborted, are recorded. As an attempt is made to solve a new problem, matchings are attempted between the evolving path of reasoning steps and those of previous problems. The solution process of a problem deemed similar is applied to the new problem. Decisions made in similar solutions are reevaluated in light of the

new problem's facts.

A somewhat more tractable, purpose-driven problem-solving approach is that taken by [Hammond, 1986a; Hammond, 1986b]. In his CHEF program, recipes are the cases. In the course of encountering planning failures in solving a problem, CHEF generalizes descriptions of combinations of features that lead to the failures in order to predict future failures before they happen. The recipes are indexed both by the gastronomical goals that they satisfy and by the problems that they avoid. The program took a problem description including surface features like ingredients and goals to be satisfied and inferred likely goal conflicts to retrieve recipes that avoided the conflict. Burstein also used a purpose and failure driven matching to link information in the problem situation, involving the use of programming variables, with that of the target domain of manipulating boxes and objects [Burstein, 1983a].³

HYPO differs from each of these AI approaches to analogical reasoning. HYPO employs a highly constrained matching process. The constraints are not general types but capture specific collections of facts that courts have said were important in deciding previous cases. With this more constrained matching, HYPO can deal with larger numbers of cases – it now has 30 cases in the Case Knowledge Base. In addition, having made matches, HYPO can reason about cases by comparing them in terms of the matched features, magnitudes, and unmatched features.

HYPO avoids relying on an *a priori* static hierarchy for determining the relative importance of features or for selecting the best matches. The relations among the features frozen into such hierarchies do not take into consideration the effects that the presence of other features or different magnitudes may have on their

³Kedar-Cabelli has also tried to address reasoning with the purposes underlying an analogy. She suggests, for example, that the purpose of a statute can be used to select the kind of analogy to draw to show that the statute has or has not been violated [Kedar-Cabelli, 1984]. Unfortunately, it is well-known that the purposes of statutes are notoriously difficult to ascertain.

significance in specific circumstances. Moreover, the decision of each new case affects the assessment of relative importance in ways not reflected in the hierarchy. HYPO's method for choosing most-analogous cases promotes cases in terms of their overlaps of selected features. Which features are more important in a given fact situation depends on the differences among the most analogous cases and their counter-examples relative to the specific problem situation.

HYPO differs from the problem solving analogical reasoners in the following respects. The problem solving researchers tend to assume that:

1. There is a strong model for solving problems in a domain. For example, Hammond's CHEF needs a strong causal theory for purposes of credit assignment and explanation so that the program can make predictions about potential planning problems from the surface features of problem situations.
2. Target cases are fully "worked out" or explained examples in light of the strong model and that the structure of their solutions can be mapped more or less directly onto the problem situation. Once a match is made the systems attempt to map the model of the target case's solution onto the problem. The structure of the explanation of the target case is used to guide inferencing about the problem, to structure a similar explanation of it and to fill in missing information.
3. Each target case was correctly decided and has only one explanation.

By contrast, HYPO avoids assuming a strong domain theory with which to structure explanations of either the target cases or the problem situation. HYPO does not assume that the target cases have a unique, structured explanation but that they may have multiple interpretations depending on the particular features, similarities and differences that become salient in light of the comparisons among the competing precedents relative to the problem situation.

HYPO does not treat a precedent as a fully worked out model of an answer to the problem situation. Instead, the most analogous precedents are treated as justifications that are combined into one overall argument. Thus, HYPO combines information from the most analogous cases.

In HYPO, the configurations of competing most-analogous cases relative to the problem situation represent important information. HYPO compares the most analogous cases symbolically and draws inferences from the results of the comparisons. Thus the differences among the most analogous cases are just as significant as the similarities. Using the information contained in the dimensions and claim-lattices, HYPO can extrapolate from near-by cases. It poses hypotheticals that combine conflicting features or exaggerates magnitudes of features. See [Ashley and Rissland, 1987b; Rissland and Ashley, 1986]. In the other programs, the differences between nearly analogous cases are translated into point differentials in the matcher. The losers are discarded. No information is extracted from the fact that they were close cases.

HYPO's differences make it much more appropriate for the kind of analogical reasoning performed in the law where there is no strong model of the domain sufficient to determine how a case should be decided or to inform explanations of how a case was decided.

2.5.3 Case-Based Reasoning and Memory Organization

One way that analogical reasoning programs can increase the range of analogies they can draw, and the work they can do with them, is to become more case-based, that is to accommodate large numbers of cases and adopt indexing schemes to retrieve and reason about relevant cases. Recent research in case-base reasoning ("CBR") on memory organization, most notably by Kolodner and colleagues, bears on the problem of retrieving relevant cases through the use of

indexing schemes. Kolodner in the question-answering system CYRUS used a database that reorganized its indexing scheme and representations of events as new information is added [Kolodner, 1983a; Kolodner, 1983b]. The system indexes events, "E-mops", according to the aspects of an event that differ from the norms of the conceptual category of the event (e.g., whether they violate expectations).

Building on this memory scheme, Simpson and Kolodner developed a case-based reasoning program, MEDIATOR, that solved problems in the domain of dispute mediation [Kolodner *et al.*, 1985]. MEDIATOR's case-base contained information on physical, economic and political disputes and common mediation tactics, their failures and corrections for those failures. Cases were indexed by their features (e.g., the disputants, their goals, disputed objects), in particular, by those causing dispute mediation failure. A classic example involved a dispute between two sisters over an orange and the failure of the tactic of dividing it equally because one sister wanted the fruit and the other the rind. In connection with a physical dispute where "divide equally" fails, the case of the orange would be recalled and lead MEDIATOR to try the alternative fruit-and-rind solution.

Having access to more potential analogues, however, poses the problem of selecting among them. In CYRUS and MEDIATOR, as distinguished from HYPO, the evaluation function for selecting a most on point case from the many retrieved by the "reminding" process takes into account only the closeness of fit to selected features which is determined by an *a priori* ranking of features types. In HYPO, on the other hand, the ranking of features is performed dynamically in light of the particular combination of features that appear in the case at hand. Prior cases are promoted according to how great a subset they share of those features. HYPO then looks for configurations of counter-examples among the most analogous cases. These configurations, or their absence, dynamically determine which features are most important given the specific facts of the problem situation.

2.5.4 Example-Based Reasoning

Reasoning with a knowledge base of cases in CBR was foreshadowed by Rissland's earlier work on example-based reasoning ("EBR") and the more recent work on hypothetical reasoning [Rissland *et al.*, 1984; Rissland and Ashley, 1986] which employs a "space" of examples or cases – an Examples- or Case-Knowledge-Base – from which to retrieve relevant examples/cases and then manipulate and modify them. In a process called *constrained example generation* or *CEG*, modifications of existing examples are undertaken with the goal of making the retrieved example satisfy needed constraints – for instance, those needed to create a counter-example to a conjecture. Rissland's "retrieval-plus-modification" idea in CEG and McCarty's "prototype-plus-deformation" idea, described below, are quite similar [Rissland, 1980; McCarty, 1980b]. In CEG, selection of modification technique is done in a means-ends manner, that is, modifications are indexed on the attribute they effect. In HYPO, potential modifications to a problem situation – i.e., the generation of a hypothetical – are indexed via dimensions and chosen according to several heuristics (e.g., make a case weaker/stronger, enable a near-miss dimension) as well as to higher level argumentation and explanation goals [Rissland and Ashley, 1986]. Thus, creation of hypotheticals in HYPO has certain similarities to the generation of examples in CEG: (1) both assume the existence of a knowledge base of cases (CKB) or examples (EKB), which is organized (typically in a net); (2) both use indexing schemes for retrieval of examples/cases and modification procedures; (3) both link new examples/cases (e.g., hypos) into the EKB/CKB in ways to reflect their construction or derivation. However, CEG is a much more simple and static system; there is no attempt in CEG, as there in HYPO, to dynamically and case-dependently view the existing case base *modulo* the problem situation.

A fundamental difference between CBR and EBR is that cases/examples in CBR are the foundation of *justification*. That is, to justify an analysis or argu-

ment in CBR, *one cites and reasons with cases*. In particular, for the cases that support the analysis or argument, one explains the connections, often analogical, and for the troublesome cases, one distinguishes them, using legally important dissimilarities as a wedge. In CBR, one does not rely solely on rule-based chaining, *modus ponens*, universal specialization or other essentially logical techniques as the primary tools. In EBR on the other hand, while examples are important components of expertise and reasoning [Rissland, 1978], they are not necessarily the basis of justification. (For instance, mathematics does not recognize “proof by example” even though examples may play a central role in mathematical reasoning involved in the discovery, formulation and debugging of a proof, which ultimately must cite definitions, axioms and theorems.)

2.5.5 Explanation

Clancey addresses the problem of controlling inference in explanation in connection with two insights – the importance of: (1) Abstraction in explanation; and (2) Distinguishing between the meaning of a proposition and the roll or use that its invocation plays in some broader context such as a diagnostic inquiry (or argument). In his seminal research on explanation, Clancey adopted a useful methodological perspective: to study how well a reasoning system explains, examine what would have to be changed to turn it into a tutorial program. Clancey identified deficiencies in MYCIN’s rules that prevent it from being easily transformed into a tutorial program, in other words, that limit the ability to generate convincing explanations of MYCIN’s decisions beyond a trace of the program’s backchaining through its rules: The order of invocation of the rules is arbitrarily defined in MYCIN; the rules are not tied to justifying principles; and there is no explicit representation of the strategies for invoking the rules [Clancey, 1983].

Clancey focusses on the inference control problem when he argues that to explain a rule, one needs to know the intermediate steps from which the conclusion

is derived from the premises. Since there may be many of these – the refinement of grain size is unlimited – one must choose which steps in the reasoning need to be explained. The purpose of the explanation and the amount of prior knowledge of the user are important in making the choice.

Clancey offers two solutions for the problem of controlling inference in explaining a rule. The *first* method is to relate the rule to an abstraction, to a generalized pattern of reasoning. He argues that key concepts in rule explanations are abstractions connecting the rules to familiar patterns of reasoning we have encountered previously and premises that we readily accept [Clancey, 1983, pages 226–7]. For example, a top level explanation of a causal rule relates the rule's predicates to a general idea of the process being explained as represented by scripts. The *second* method is to relate the rule to the strategic role that invoking the rule plays in the diagnostic inquiry. Clancey recommends making strategic principles explicit (e.g., Common (frequent) causes of a disorder should be considered first; If nothing has been observed, consider situations that have no visible manifestations; If unable to make a deduction, assume the most probable situation; If there is evidence for two hypotheses, A and B, that tend to be confused, then try to rule out B.) This allows separating what a heuristic is from how it will be used and is reminiscent of the lesson from argument discourse research, described above, that a proposition's meaning should be distinguished from its force in argument.

Researchers have adopted a variety of other specialized knowledge representation techniques for accomplishing Clancey's goal of abstracting the right information for accomplishing the strategic purpose of the explanation. For example, [McKeown *et al.*, 1985] describe a system that advises students about what courses to take. The program uses a rule based system to answer yes or no questions about what courses the student can take and a trace of the rule invocations to provide a supporting explanation. The program infers the perspective of the

student's question and tailors the explanation accordingly by allowing rules relevant to that perspective to be invoked. The program represents each different perspective (i.e., prerequisites, scheduling, etc.) with separate but intersecting concept hierarchies. To construct the explanation, the system determines the questioner's goal, selects the appropriate hierarchy and the information about the inquired-of object from that perspective is put into working memory. The information extracted from one hierarchy will allow a different set of rules to fire than will information extracted from another, producing a different explanation.

Clancey sees a connection between argument and explanation in the distinction between the reasoning process with which an expert comes to a conclusion and the process of explaining the conclusion. He observes that diagnostic rules are arguments that a process has occurred in a particular way [Clancey, 1983, page 230] and that the abstract concepts useful for providing good explanations may not necessarily be useful for driving the diagnostic reasoning process:

As we discovered when explaining the rules, not all of the causal steps of the process can be directly confirmed; we can only assume that they have occurred. For example, rather than providing diagnostic clues, the concept of "portal of entry and passage" is very often deduced from the diagnosis itself.

According to this view, principles are good for summarizing arguments, and good to fall back on when you've lost grasp on the problem, but they don't *drive the process* of medical reasoning [Clancey, 1983, page 233].

After the diagnosis has been constructed, a causal argument is used to "prove" that the diagnosis is correct. "Thus causal knowledge can be used to provide feedback that everything fits." ... "But [a student] will be an inefficient problem solver if he always attempts to directly convert that [causal] model to a subgoal

structure for solving ordinary problems.”⁴

The connection between explanation and argument is much stronger than Clancey allows. Playing out alternative sides of an argument is a good way to make an explanation. Most diagnoses can be argued more than one way. Arguing about the rejected alternatives, even if only to discount them, is an effective way of justifying and explaining the alternative that was adopted.

Clancey has also missed the fact that citing a well selected case examples is another good way to illustrate and explain a point. Human experts frequently cite similar cases as a way of persuading us to believe their analysis. They also use hypothetical cases as a way of illustrating how the analysis depends on certain crucial facts which if altered as in the hypothetical would lead to other conclusions. Much as in explaining with rules, the trick in explaining with case examples is abstracting the right features of the case example to accomplish the strategic purpose of the explanation. In HYPO, dimensions are used to focus on the features of a case that are relevant in citing that case as a predicate in an argument supporting a claim. HYPO's dimensions are its special purpose knowledge representation structure designed to abstract the facts relevant from the perspective of a particular claim.

Adversarial, case-based methods of explanation surely pass muster given Clancey's methodological interest in explanation as tutoring. Good tutors pose training case examples to their students and invite them to argue all sides of the issue of how to decide them. Tutors often modify the examples hypothetically, sometimes posing extreme cases, to get their students to realize the limits of their positions.

Case examples play an especially important role in domains that do not have

⁴The insight that principles useful in explanations may not drive the reasoning process is certainly applicable in domains like the law. Rule-like principles of law, for example, are frequently invoked to rationalize decisions made on the basis of other (including case-based) considerations.

a strong model. Much has been made recently of *explanation-based learning* systems. As Doyle has argued, the ability of such systems to “learn” from examples depends on the existence of consistent domain theories [Doyle, 1986].

In these *explanation-based learning* methods ..., an explanation derived from a domain theory shows why a particular example is an instance of some concept. After the critical constraints in the explanation are determined, its components are generalized while maintaining these constraints; the result is a generalized recognition rule for examples of the given concept.

[The approach is well understood for domain theories assumed to be consistent.] Explanations derived and generalized from consistent domain theories constitute *proofs* which can be taken to be correct in the context of all reasoning tasks they may subsequently support.

However, most domain theories are not consistent – they incorporate defaults, they omit details, or they otherwise abstract away from a complete account of the constraints which may be relevant to the reasoning tasks to which they are applied. Explanations derived and generalized from inconsistent domain theories cannot be assumed to be always correct; their inherent abstractions may manifest when inferences derived from them are not corroborated [Doyle, 1986, page 538].

Doyle recognizes the need for a different kind of explanation capability in domains that do not have consistent domain theories. In Doyle’s domain, explaining how physical mechanisms work in terms of common sense theories of causal mechanisms, the theories may be inconsistent because of approximations that suppress potentially relevant detail. Doyle constructs multiple layers of explanation to guide the process of elaborating an explanation. A failure to plan a plausible causal explanation at one level motivates descending to a more detailed level in search of more detailed building blocks with which to construct a plausible causal explanation of the effect. Each layer is more abstract than that below in the sense that it ignores constraints that are relevant at the lower level or assumes they are satisfied. Besides approximation, Doyle identifies a number of types of abstraction between the explanation layers including qualitization in

which a continuous description is collapsed into a discrete one. (e.g., on/off barriers become variable) and aggregation in which complex structures are subsumed under simpler ones. (e.g., gas as molecules in motion vs. as volume, temperature, pressure.) Doyle points out that even the lowest levels of explanation can use abstractions, which imply missing knowledge. One possible way to access usable knowledge, he suggests, but does not develop, is through analogy [Doyle, 1986].

Extrapolating from analogous case examples is a way of supplying knowledge missing because the rule-based explanatory mechanisms of a system have bottomed out. A system that has knowledge of how cases associated with a concept can be changed hypothetically to make the arguments that they are instances of the concept stronger or weaker can infer whether a new case is an instance of the concept by comparing it with previous cases. In effect, the system makes inferences by extrapolating from precedents. In HYPO, dimensions provide the knowledge of how to strengthen and weaken cases.

The exigencies of argument drive an arguer to find counter-examples or ways to distinguish cases in much the same sense that explanation failures drive an explainer to descend to a lower level of explanation. The dialectical necessities of bringing a fact situation within a rule or avoiding the rule completely lead an attorney to delve into the particulars and make detailed factual comparisons to analogize the problem situation to some precedents and distinguish it from others.

2.5.6 AI Models of Legal Reasoning

Since adversarial, case-based reasoning is so important in law, AI research in the legal area could be expected to have addressed the issues of argumentation, case comparison and inference control. And to some extent it has.

McCarty has addressed argumentation and case comparison in his research

on legal reasoning. The object of his TAXMAN II project was to produce a formal theory of legal argument. McCarty presented a three-part scheme called "prototypes and deformations" for representing legal concepts including a:

1. **Logical Template** or invariant that specifies the necessary but not sufficient conditions for the concept to apply;
2. **Set of Exemplars** or cases, real or hypothetical, where the concept does or does not apply; and
3. **Set of Transformations** that specify how one gets from one exemplar to another and what features of the exemplars can be compared.

The prototypes and deformations were designed to model the rhetorical strategy of arguing that a disputed case was an instance of a particular concept by constructing a sequence of mappings or invariance-preserving transformations from a prototypical case exemplar of the concept to the disputed case [McCarty and Sridharan, 1982]. McCarty's legal domain was an area of corporate tax law involving determining whether corporate distributions are taxable. The concepts represented included "taxable" and "nontaxable transactions". The exemplars ranged from the "clearly" taxable cases of a distribution of a cash dividend or of stock of another corporation to the "clearly" untaxable case of unrealized appreciation in the stock of a corporation. The disputed case (the case of *Eisner v. Macomber*) involved a distribution of the stock of the same company.

McCarty's hand simulation showed how the arguers (the majority and dissenting opinions in the case) could make the disputed case "like" or "unlike" exemplars of either concept by performing transformations that preserved various properties of the stockholder / corporate relationship such as the before and after ratios of stock owned by the distributees.

McCarty proposed criteria of coherence in a legal domain and described how in a legal argument arguers select “moves in the space of possible concepts” that induce coherence in the arguer’s position and reduce coherence in the opponent’s. Coherence reflected in part consistency with exemplars of the concept. Moves included constructing invariants and transformations for a concept which could be attacked or confirmed by reference to exemplars [McCarty and Sridharan, 1982]. The goal of the arguers, in McCarty’s view, was to minimize inconsistency, to find the right transformations that successfully linked the disputed case to positive exemplars of the desired concept with out also linking it to any of the negative exemplars of the concept.

More recently, McCarty has worked on a theory of permissions and obligations to represent the legal effects of actions [McCarty, 1985]. He hopes to design a logic for specifying in detail the rights and duties associated with various legal relationships such as that of a stockholder and the corporation. In this way, he hopes to expand and systematize a description of a transaction so that there are more possible transformations and invariants for the rhetorical process to work with.

McCarty’s focus on modelling adversarial reasoning in law and on reasoning by comparing prototypical cases of concepts are a significant advance. He more than anyone points the way toward integrating case-based and logical methods in law. There are problems, however:

- The work is largely an exercise in knowledge representation. McCarty does not set forth a control or process model that clarifies how a program would actually generate a legal argument [McCarty and Sridharan, 1981; McCarty and Sridharan, 1982]. The reported research involves a hand simulation of the arguments in one United States Supreme Court case and work was also done on hand simulations of several subsequent cases.

- McCarty's mechanism for controlling the complexity of inference is that the positive and negative exemplars of the concept guide the search for mappings. But how much inference is needed to find useful mappings that discriminate between positive and negative exemplars in a consistent way for a side? As the numbers of exemplars, possible transformations and invariants grow, so does the complexity of comparing the exemplars and finding useful matchings, especially assuming that the mappings have to be assessed for consistency with other possible mappings. In addition, his space of possible concepts is small.
- Legal arguers make other kinds of comparisons of cases not handled in TAXMAN II. They compare cases in terms of the relative strengths and weaknesses of the plaintiffs' positions and how close an analogy a precedent case is to the disputed case. TAXMAN II has no mechanisms for comparing cases in terms of how on point they are, for distinguishing cases, or for selecting the best precedents.
- McCarty's model assumes a much neater domain than exists in law. He assumes that in reality, legal cases are consistently allocated as positive and negative exemplars of concepts. They are not. He assumes that there is a neat match between concepts and the features of a case that are relevant to the concept. There is not. He assumes a domain of "sanitized" positive and negative exemplars of a concept whose relevant differences with respect to the concept are readily compared because other differences that affect the strength of the overall argument are ignored. Thus cases are compared as if all other things were equal, when they are not.
- His efforts to define a set of primitives in terms of permissions and obligations place the cart before the horse. Far from being primitives, the effects of a legal action on permissions and obligations is an arguable legal conclusion requiring the same kind of arguments he is trying to model.

Of the researchers who have focussed on modelling reasoning with legal rules, Gardner has taken the most realistic view of the limitations of legal rules and has recognized the role of case-based argument in dealing with those limitations.

[Gardner, 1987] developed a system to identify legal issues in the analysis of law school examination fact patterns involving the contracts law of offer and acceptance. The program's legal knowledge of contracts law consisted primarily of twenty if-then rules, positive and negative examples of some of the predicates employed in the rules, and an augmented transition network. The rules defined such domain concepts as offer, acceptance, counter offer, and rejection. The program had a number of heuristics for distinguishing "hard" and "easy" legal issues that were encountered in determining if the rules applied. The question was treated as hard if any of the following occurred:

1. Contradictory rules applied;
2. The rules "ran out" (i.e., were inconclusive or had unresolved predicates) and the situation matched both positive and negative example cases of the predicate; or
3. The rules ran out and there was no match to an example case to resolve the predicate.

Although the heuristics are an important advance, an attorney distinguishes hard from easy questions in terms of comparing the strengths of the best argument he can make with the best arguments his opponent can make. Gardner's program provides no measure for evaluating the strengths of competing arguments. Gardner referred to, but did not implement, a final stage of reasoning which would have produced arguments on both sides of hard questions. IIYPO does make arguments citing cases on both sides of an issue and compares arguments by comparing the most analogous precedents that can be cited on either

side of the issue.

Even if Gardner's program evaluated case-based arguments, it could not do so very realistically given the way cases are represented. Distinguishing, for example, is not possible because there is nothing to distinguish. Although Gardner's examples were abstracted from real cases and indexed by the legal predicates they exemplified, they consisted of simple rule-like patterns including only the generalized facts relevant to satisfying the predicate and eliminating features inconsistent with or extraneous to interpreting the case according to the program's rules.

Other memory organizations have been proposed for relating cases to the legal concepts they supposedly exemplify. Goldman *et al.* are exploring the use of MOPs-type memory structures to index and organize cases according to legal concepts like legal-offer or conditional-offer [Goldman *et al.*, 1987]. In their "explanation-based" STARE program, positive and negative case examples of the concept are indexed according to their conceptual differences, for example a failed precondition that causes one example to be a legal offer and the other not, or differing surface features. This memory structure may impose more conceptual coherence on the cases than is warranted in that it appears to assume the existence of a strong theory for explaining why a case is a negative instance of a concept and for determining which differences are relevant in that connection. In real legal domains, there may be no such theory, or worse, several. In any event, the MOPs-type structures for legal ACTs and relations are intended to supplement CD, goals and plans to enable the program to interpret natural language descriptions of legal fact situations. Like McCarty, Goldman and Dyer propose to define legal primitives. The problem with such primitives, if they are taken too seriously as a means for defining concepts, is that they assume what is to be shown. Far from being a primitive, that someone has a right or duty in a given fact situation is an arguable legal conclusion that must be justified by citing authorities. On the

other hand, legal primitives may play an important role if the program uses them as a means for identifying the tentative legal conclusions for which it should seek to make case-based arguments.

Hafner has proposed a different kind of concept / case organization called an "issue / case discrimination tree" to structure a collection of legal cases for purposes of conceptual text retrieval [Hafner, 1987]. The tree organizes positive and negative case examples of a concept according to issues and factors that positively or negatively affect the outcome. The factors are based on "dimensions" as discussed below and previously discussed in [Ashley, 1986]. Hafner apparently foresees incorporating such trees into the organization of a database of cases.

Other research focuses on rule-based models of legal reasoning without attempting to model adversarial reasoning or to address the problems of reasoning with rules that case-based reasoning does. For example, Waterman and Peterson employed a classic rule-based approach in implementing a model of how lawyers estimate the value of products liability and negligence cases [Waterman and Peterson, 1981]. The model, part of a planned larger system for settlement negotiations, used if-then rules to model the substantive law. Waterman estimated that it would take thousands of rules to model estimating the value products liability suits involving auto accident. Although he recognized the problem of using rules to represent the meanings of ill-defined predicates like "unreasonably dangerous" or the "foreseeability of injury", he suggested using ever more refined rules to show how the terms were applied in particular contexts or simply asking the user [Waterman and Peterson, 1981]. As Gardner points out, the lessons of jurisprudence imply that the former tack - definitional backchaining - often fails. And while the latter certainly resolves an ill-defined predicate, it also casts doubt on the program's level of expertise. At least a program should guide the user's choice by showing positive and negative examples of the predicate.

In an early work that also emphasized representing substantive rules, Meld-

man developed a system to analyze fact situations involving intentional tort claims like assault and battery [Meldman, 1977]. The program had two kinds of rules: (1) general rules defining the elements of the claims; and (2) more specific rules defining when the elements were satisfied. The latter, in effect, were structured examples abstracted from the facts and holdings of real cases. The program attempted to match the case at hand to the elements of a claim by matching facts to the structured examples. A match entailed finding common facts or common ancestors in a generalization hierarchy. Meldman's use of rules (to define the elements of a claim) and that of Gardner (to define the ingredients of contract law) were similar. Also Meldman's use of cases as rule abstractions was somewhat similar to Gardner's use of case examples to resolve ill-defined predicates in the general rules. Meldman, however, treated each case as having a unique holding and dealt only with positive examples of a claim. He did not attempt to model arguing the analysis both ways.

Some more recent proponents of rule based expert systems in the legal domain, including Schlobohm and Michaelsen, have attempted to find tasks and domains where the costs of rule-based approaches are acceptable given the routine nature of the fact situations, more detailed statutory definitions of the predicates, or greater acceptability of asking the user. Michaelsen's program makes liberal use of asking the the user to draw complex tax conclusions for which it provides no explanation or guidance [Michaelsen, 1984]. Schlobohm has attempted to expand the ability of his program to explain concepts to a naive user by attaching textual definitions to various rules and frames; the program does not utilize case examples and hypotheticals to explain what would have caused a different decision to have been made [Schlobohm and Waterman, 1987].

Far more extreme are the proponents of logic representation schemes for reasoning about statutes. Sergot, et al. [1986] and Bench-Capon, et al. [1987] have represented fragments of the British Nationality Act and the Supplemental Ben-

efits Law as “logical models” [Sergot *et al.*, 1986; Bench-Capon *et al.*, 1987]. The models are unable to deal with alternative interpretations of the statute and make no provision for employing cases to supplement the ambiguous, ill-defined predicates of the statutes. Instead, they apparently ask the user to decide whether a predicate applies or provide *ad hoc* definitions for the predicates, definitions that are not sanctioned by any legal authority like a legislature or a court, but are introduced only to make the system “work”.

Such logic-based attempts have also ignored the ambiguities introduced by the logical connectors in the statutes. “Simple” connectors like “and”, “or”, “unless” and “except” introduce myriad alternative interpretations of the logical structure of even the simplest statutes [Allen and Saxon, 1987].

CHAPTER 3

The Law as a Paradigm of Case-Based Argument

Case-based argument plays an essential role in legal argument. An attorney's law school training and legal practice inculcate standards of legal argument and those standards strongly prefer arguments whose conclusions are justified by citing precedents (i.e., prior legal cases). In the American legal system, there is also a strong theoretical reason why case-based arguments are preferred. Under the Common Law doctrine of *stare decisis*, like cases are decided alike. Courts are bound to decide a case in accordance with the most analogous precedent.

3.1 A Scenario

To get a flavor of what legal arguments are like, let us examine the quandry of a fictitious attorney in dire need of an argument:

It was 5:55 PM. An associate of a major New York law firm, sat in the walnut-paneled library of 13 Wall Street. He had opera tickets in his pocket for 8:00 that night – “Pagliacci” – and his socialite fiance and her parents were to meet him at the Met. At 5:00, just before leaving for the day, Howe, a partner in the firm, buttonholed the associate in the elevator. Howe recounted to the associate a telephone conversation between Howe and the house counsel of one of the firm's

big oil company clients, AMEXXCo. The house counsel had been very angry. She complained that AMEXXCo was getting "shafted" by a particular former employee named G. Whiz. Mr. Whiz had developed a computer program, called DIPPER, for analyzing drilling logs of oil wells. Last week Whiz quit, started his own consulting company, and was about to enter into a contract with AMEXXCo's competitor, EXXSSInc for computerized analysis of oil drilling logs. The house counsel wanted to know "ASAP" whether AMEXXCo could get an injunction against Whiz and EXXSSInc preventing Whiz from using or disclosing anything about the DIPPER program. Howe promised to have an answer by 10:00 AM the next day. And that is why the associate sat in the walnut-paneled library as the hands of the brass pendulum clock showed 6:00.

There was more to Howe's story. Apparently Whiz, an expert on drilling log analysis, has a background in some arcane computer science specialty. Howe thought she said "AY". Just like Howe to get it wrong, thought the associate. The house counsel had told Howe she was particularly worried about the fact that although Whiz was on the AMEXXCo payroll, he developed the DIPPER program on his own initiative. For four years, AMEXXCo had repeatedly directed Whiz to drop the DIPPER in favor of another approach. Then, a couple of weeks ago, in an experiment cooked up by Whiz, the DIPPER actually discovered a major producing well. Last week Whiz quit over a dispute about salary and the use of the DIPPER program. "At least," thought the associate, "Howe had sense enough to ask the house counsel whether Whiz had signed a nondisclosure agreement with AMEXXCo." Whiz had signed such an agreement when he first began working for AMEXXCo, long before he started work on the DIPPER.

Trade secrets law wasn't exactly the associate's field. On the one hand, the facts that there was a nondisclosure agreement and that Whiz was an AMEXXCo employee when he developed the DIPPER program seemed to him to help AMEXXCo's position. On the other hand, it sounded like Whiz had been right about the DIPPER program all along and AMEXXCo had been wrong. If Whiz hadn't been persistent enough to continue working on DIPPER over AMEXXCo's objections there wouldn't be a DIPPER program to scrap over. Whiz ought to have some rights to the program. But what rights? All? None? "If it were up to me," the associate thought, "I'd give the guy a break, but Howe isn't billing me out at \$250 per hour to do justice, and now its 6:10 and the taxi ride is going to take at least 45 minutes."

In any event, the associate knew that whatever conclusion he might come to, the house counsel was not going to take his word for it, or Howe's for that matter. She would have to be convinced, and it would take a legal argument to convince her. And at 6:15 PM, a legal argument was precisely what the associate did not have. "Muffy and her parents have probably left Manhasset by now," he thought as he glanced at his watch.

3.2 What a Legal Argument Should Be

The associate needs to make an argument fast. Although he may not be an expert on trade secrets law, as an attorney, he knows what a legal argument looks like and how to tell if it is a good one. He knows what the facts of the dispute are, or at least some of them, and his firm's library contains most of the world's recorded knowledge on the subject of trade secrets misappropriation. The trick is to find the most relevant bits of that mountain of arcana that would justify AMEXXCo's position.

Before continuing with the scenario, let's take a moment to understand the associate's task and to define some legal terms.

The associate has been asked to provide a very specific kind of information, a legally justifiable argument in favor of AMEXXCo on which to base a decision by AMEXXCo to commence a lawsuit against Whiz and EXXSSInc to enjoin them from using DIPPER. The associate knows who the parties to the law suit will be – AMEXXCO will bring suit as the plaintiff (or "II") against EXXSSInc and Whiz as defendants (or "Δs") – and that he represents the plaintiff's side.

The associate's answer will take the form of a legal memorandum setting forth:

1. A summary of the facts of the dispute as he knows or assumes them to be.

2. A description of the claims that AMEXXCo can bring against Whiz and EXXSSInc. A claim is a recognized form of complaint for which the courts will grant relief such as trade secrets misappropriation, breach of contract, copyright or patent infringement, or negligence.
3. For each claim, a summary of the legal points that can be made for or against AMEXXCo's position on the claim.

While there are no hard and fast rules for what a point in a legal argument should be, attorneys would expect to see three components:

1. **Legal Conclusion:** Of the many kinds of legal conclusions, we will be concerned primarily with assertions that a side in a particular fact situation should win or lose a claim.
2. **Justification:** In a legal argument, a justification is a citation to an authority in support of the legal conclusion. There are four main kinds of authorities to cite in a legal argument:
 - (a) Legal cases;
 - (b) Court-made rules or principles;
 - (c) Provisions of statutes, constitutions, and administrative regulations;
 - (d) So called "secondary authorities" including scholarly legal works such as treatises.
3. **Rationale Why the Justification Applies:** For each kind of authority there is a fairly standard way of substantiating that the authority cited in the justification applies to the particular facts of the current dispute.

The associate's task, then, is to determine what points can be made in a legal argument in favor of AMEXXCo. He must decide what kinds of legal claims

AMEXXCo can assert against Whiz and EXXSSInc, search his legal library for authorities to cite and explain why the authority justifies the conclusion that AMEXXCo should win those claims.

3.2.1 Justifying by Citing Precedents

In the context of planning a law suit, the most important points the associate can turn up are those that cite precedents as authorities. The partner and house counsel will feel secure about assessing a lawsuit's prospects only if they can see and compare their client's fact situation with the cases they would cite in making an argument before the court and the cases that would be cited by Whiz and EXXSSInc against them.

When the justification cites a legal case, the argument is an argument by analogy. The advocate asserts the legal conclusion that the current dispute should be decided in the same way as the cited case. His rationale is to draw an analogy between the current dispute and the cited case by pointing out the important similarities between them.

For purposes of drawing an analogy to a prior case or precedent, the similarities that matter involve facts that constitute strengths or weaknesses in the plaintiff's position on that claim. The plaintiff can make a strong point for its position on a particular claim if it can cite a case:

1. Won by a plaintiff;
2. Involving the same kind of claim;
3. Having the same plaintiff's strengths and weaknesses in common with the current dispute.

Even when the cited authority is a statute or a court-made rule or policy, the

preferable way to make an argument is still to draw an analogy to precedents in addition to citing the statute. An advocate who seeks to show that a statutory provision or court-made principle applies to his client's facts finds other previously decided cases, selects those in which courts have decided in favor of the same side that the provision or principle applied, and argues by analogy that the court should decide in favor of his client because his client's facts are the "same" as those presented in the precedent.

The question of what strengths and weaknesses matter for a particular claim is important and controversial. One answer is that a strength or weakness matters if there is case, either the cited case or some other precedent, where the court has held that the facts associated with the strength or weakness made a difference in the outcome of the case, either in favor of the plaintiff or the defendant on that claim.¹ When asserting that a particular strength or weakness in a side's position makes a difference to the outcome, an attorney is always in a better adversarial position if he can cite a case where a court held that a similar strength or weakness mattered for that type of claim.²

3.2.2 What Precedents to Cite in a Point

The associate must find the right precedents to cite on behalf of AMEXXCo, but what are the right precedents? There are five basic criteria:

¹ A *holding* is the conclusion of the court as to the legal effect on each claim of the facts of the case, either in favor of the plaintiff or the defendant.

² There are other answers to the question of what strengths and weaknesses matter for a claim. The issue is bound up with the controversial question of what determines the importance of similarities and differences in analogical legal reasoning. Despite the existence of a jurisprudential debate, discussed below in Section 3.4, in practice attorneys make arguments by analogy all the time.

1. **Same Claim:** The precedent should involve the same claim as the conclusion for which the attorney is arguing.
2. **Same Side:** The side who won the precedent should be the same side for whom the attorney is arguing.
3. **On Point:** A precedent is **on point** to the extent that it shares the same strengths and weaknesses as are present in the current dispute.
4. **Most On Point:** The goal is to find the most on point precedents, the cases sharing the most strengths and weaknesses in common with the current dispute. These are the cases most analogous to the current dispute. In particular, the goal is to find cases that are more on point than any cases that held for the opponent's side.
5. **Highest Pedigree:** All courts are not equal, and thus neither are all precedents. They have pedigrees. Precedents are better authorities to the extent that they were:
 - (a) Decided by a court of the same state whose law applies (i.e., a court of the relevant jurisdiction); ³
 - (b) Decided by the highest court of the relevant jurisdiction;
 - (c) Decided after a full trial on the merits of the claim;
 - (d) Never overturned, distinguished or questioned by a subsequent court of the same or higher rank.

The associate's goal is clear. He must find the most on point cases with the highest pedigrees that favor AMEXXCo as the plaintiff, the side he represents. For example, he needs some precedent cases involving claims for trade secrets

³Figuring out which state's law applies may be a complicated issue that will also require case-based arguments to resolve.

misappropriation or breach of a nondisclosure agreement where an employee who signed a nondisclosure agreement worked on a product, then left to work on his own or for someone else using the information about the product and where the plaintiff won despite the fact that the employee was the sole developer of the product. He can use these cases to make strong points for AMEXXCo.

If the associate cannot find cases that are exactly on point, that is, that share all of the strengths and weaknesses in common with the current dispute, then he will settle for cases that are as on point as possible. His points, however, will not be as strong to the extent that:

1. His cited cases are not on point or
2. There are even more on point cases for the opponents to cite in response.

3.2.3 Responding to Precedents

Since the associate can be sure that his opponents will point out the failings of his cited cases, he must also consider their possible responses to his points in order to evaluate the strength of his side's argument. In general, responses to a precedent-citing point in a legal argument consist of combinations of the following:

1. Distinguishing the cited case;
2. Citing a real (or hypothetical) case as a counter-example;
3. Attacking the cited case's pedigree;
4. Citing a contrary statutory provision or policy.

Distinguishing a cited case is a primary means of responding to it. An advocate argues that the case is *not* analogous to the fact situation by pointing out strengths and weaknesses that they do not share and that justify not treating the former as a precedent for the latter. If the point being responded to was made on behalf of Side 1, facts that favor Side 1's opponent, Side 2, in the current dispute but were not present in the cited case, or that favored Side 1 in the cited case but were not present in the current dispute, are distinctions. According to this kind of response, there is no need to follow the cited case as a precedent if the current dispute presents relative strengths for Side 2 not considered in the cited case.

Citing another precedent as a counter-example is a second important way of responding to a point. A counter-example is a case that shares some of the same strengths and weaknesses with the case at hand as Side 1's cited case, but held never-the-less for Side 2. By citing a counter-example, Side 2 makes a point for its own side (i.e., it draws the analogy between the counter-example and the case at hand) and uses the contrasting result to show that the analogy drawn by Side 1 is not compelling. Some counter-examples are better than others. A counter-example is more persuasive to the extent that it is:

1. More on point than the cited case, that is, to the extent it has more strengths and weaknesses in common with the case at hand than the cited case; or
2. An extreme example of some of the same pro-Side 1 features as the cited case but still held for Side 2.⁴

A response can also attack the cited case's pedigree. Essentially, the attorney argues that the court is not bound to follow the cited case because the cited case:

⁴A response may also cite a hypothetical case as a counter-example. A hypothetical is a made-up factual dispute that may look like a real case but has *not* been decided by a real court. The use of hypotheticals in legal argument is discussed below.

- was decided by a court from another jurisdiction,
- was not decided by an equivalent or superior court in the judicial hierarchy,
- was overturned, distinguished or questioned by a subsequent higher ranking court, or
- involved a procedural setting that did not fully present the issues.

Statutory provisions, court-made rules and policies also can be cited in response to a point. Side 2 may cite a provision or policy that contradicts the point's conclusion. Such a response would be improved by citing a case where the court expressly applied the provision or policy in holding for Side 2.

3.2.4 What About Other Facts?

As the associate builds his points and responses, inevitably he must worry about whether he has all of the facts. The House Counsel may not have told Howe all of the facts that are relevant to the dispute. She may not have conducted a thorough investigation; she even may not know all of the kinds of facts that would be relevant. Even if facts are known, they still must be proven at trial. If the precedents indicate that a particular fact is crucial, the associate must plan for the contingency that his side will fail to prove it. Also, he does not know what facts the opposing side may prove.

The associate's memorandum should flag these contingencies. It should pose hypotheticals like:

What if AMEXXCo has disclosed information about DIPPER to customers or in professional articles or sales literature?

What if AMEXXCo has failed to take adequate measures to protect its trade secret information in DIPPER?

3.2.5 Evaluating a Legal Argument

After the associate has assembled all of the on point cases he can find for both sides, he, Howe and the house counsel will have to assess how strong an argument each side can make. They must try to decide whether they have adequate grounds to commence a lawsuit and whether they have a winning argument. They will ask questions like the following:

1. Do we (representing plaintiff) have cases to cite on a claim?
2. Do they (representing defendant) have cases to cite?
3. Are our cases distinguishable?
4. Are any of their cases more on point than any of ours?
5. Can either side cite any cases for which there are no more on point counter-examples?
6. Have any of the cases been overturned?
7. Are there significant contingencies for which we do not have information?
8. What cases can we cite if the contingencies occur?

It is noteworthy that one thing the attorneys *cannot* do is deduce how strong their legal argument is from the language of the statutes or the restatements of the law in the legal treatises. Appendices D and E show excerpts from some representative statutory provisions and restatements. The text is far too general to determine whether the concepts apply to the fact situation or not. Even if they do, no attorney would be satisfied with citing just such a provision in support of his argument but would also seek to cite cases as authorities.

Similarly, the various statements of the “elements” of a legal claim propounded by courts or scholars are unavailing. The elements of a claim are generalized statements of the facts that must be proven in order to prevail on the claim. There is little agreement about the elements of a trade secrets claim. Compare the statement in [Gilburne and Johnston, 1982, page 215] that there are three elements as a condition of the existence of the trade secret: “novelty, secrecy and value in the trade or business of the putative trade secret owner” with the fact that neither [Milgrim, 1985] nor [Nimmer, 1985] are willing to list the elements of a trade secrets claim. As suggested below, the primary utility of these statements of a claim’s requirements are not as definitions but as annotated guides to cases.

3.2.6 Finding the Cases

How can the associate come up with the right cases to cite in a legal argument? The firm’s legal library offers the associate many routes into cases that he may cite. The major ones are:

1. **Digests:** The associate can search manually through one of the many legal digests. The digests have hierarchical indices to cover major areas of the law such as trade secrets. The attorney would need to examine the many entries to the index looking for promising entries such as “employee” and “nondisclosure agreements”, turn to the digests and manually scan the case annotations looking for cases that appear to have interesting similarities to the current dispute.
2. **Annotated Statutes and Treatises:** Similarly, the associate can examine the case annotations listed in the statutes and legal treatises dealing with trade secrets misappropriation. Reporting services index cases interpreting a particular statutory provision. The attorney must know what statutory provisions might be relevant to his fact situation. In treatises,

legal propositions are annotated in footnotes containing cases that are examples of or counter-examples to the proposition. In order to find relevant propositions and cases, the attorney must scan the table of contents or use the index of legal concepts to find potentially useful propositions and then scan the footnotes.

3. **Full-Text Retrieval Systems – LEXIS or WESTLAW:** These systems contain immense databases of the full text of legal cases. See [Sprowl, 1976a; Sprowl, 1976b]. The attorney fashions queries using logical strings of key words like “trade secrets”, “employee”, “nondisclosure agreement” or “sole developer”. The system retrieves all cases evidencing the key words ranked according to statistical criteria. The attorney must know what key words to use and be prepared to scan the cases returned by the system.
4. **Other Computerized Legal Databases – SHEPARDIZING:** *If* the attorney knows of a relevant legal case, he may easily find all other cases that cite the case approvingly or disapprovingly some of which are likely also to be relevant. The cross-references among legal cases are extensively documented in physical volumes and computerized databases.

All of the above routes of access have disadvantages. Manual searches are time consuming. Index entries may be too general to quickly focus the attorney on cases that share important analogous features. The indices tend to have numerous entries any of which might contain relevant information, all of which have to be examined. The visual scan of the annotations under each entry is thwarted if the descriptions of the cases are too general to disclose the particular features.

The full text retrieval schemes have all of the problems of key word searches [Blair and Maron, 1985; Hafner, 1987]:

1. **Ambiguity:** The same key words have different meanings in various legal areas leading to retrieval of irrelevant cases.
2. **Synonyms:** Relevant cases are omitted because they employed synonyms of key words.
3. **Query composition:** The attorney may not know the best, or even appropriate, key words to use.
4. **Screening:** The statistical criteria used to rank retrieved cases have little to do with the actual relative utility of the cases for the attorney's purpose. In attempting to pare down the list of retrieved cases to a manageable number, the attorney is forced to add logical qualifications to the query that arbitrarily skew the search discarding potentially relevant cases.

This dissertation presents an alternative route into the cases not listed above: The associate could have used HYPO. In response to inputting into HYPO the *Amexxco* fact situation at the beginning of this Chapter, HYPO outputs:

1. a Citation Summary of the best cases for each side.
2. 3-Ply Arguments showing how those and other relevant cases can be cited and responded to.
3. Suggested Hypotheticals that indicate potentially significant hypothetical modifications of the fact situation.

Figures 1, 2, 3, and 4 show excerpts from the output HYPO actually generates in response to the *Amexxco* fact situation. HYPO's process is described generally in Chapter 4. A detailed account of the analysis of the *Amexxco* fact situation is set forth in Section 5.2.

The outline of citations, arguments, and suggested hypotheticals would have been extremely useful in preparing the associate's memorandum. The cases are already organized to show the strengths and weaknesses of each side's legal argument, the best cases each side can cite and how the opponent would respond to points citing the cases and what other significant cases would come into play if certain hypothetical facts were added to the fact situation. None of the other search methods can tailor the selections of cases or explanations of their utility in an argument to the specific facts of the problem situation. Using any of them, the associate must still decide for himself how the cases retrieved can be used in arguments about his particular fact situation, whether there might be better cases to cite for or against his position and whether there are potential facts that might seriously affect the argument. Moreover, using any of the other methods, the attorney must perform a legal analysis of his fact situation and anticipate what he is looking for before he can find it. With HYPO, he simply describes the facts of the problem. HYPO performs the analysis.

Alas, the story does not have a happy ending. Since the associate's firm did not have HYPO, he was late for the opera. His future father-in-law was so incensed that the wedding was postponed. Although, the associate never found the *Amoco* case, Amexxco's House Counsel did (Her office did have HYPO) and she decided that that she no longer needed the services of a high-priced New York law firm. The firm thus lost a valuable corporate client. Although the associate never became a partner, he is considering returning to graduate school. Computer Science, maybe?

3.3 The Role of Hypotheticals in Legal Argument

At this point we will leave the associate to his fate to consider more closely the role of hypotheticals in legal argument. If an advocate cannot find a prece-

dent that puts an issue squarely, he may make one up by posing a hypothetical. Hypotheticals are usually designed in such a way that *if* they were to be decided by a real court, they would present some interesting quandries, the resolution of which would have a significant effect on how to decide the case at hand.

For some examples, let us look at how masters of legal argument pose and respond to hypotheticals, the Justices of the United States Supreme Court and the advocates who practice before them. The recorded oral arguments before the Supreme Court, and the written briefs and opinions of the cases, are a repository of case-based argument. The Justices are particularly famous for posing hypotheticals as both analytical and rhetorical tools to expose the strengths and weaknesses of a legal position. To the chagrin of counsel before the bar of the Supreme Court, the Justices frequently interrupt an attorney's oral presentation to pose hypothetical fact situations to which the attorney must respond.

Like other judges, lawyers and law professors, the Justices pose hypotheticals for a variety of purposes in legal argument, to:

1. Compare a fact situation to significant cases from past experience.
2. Factor a complex situation into component parts (e.g., by exaggerating strengths, weaknesses or by hypothetically eliminating features.)
3. Create a test case that puts an issue or pits competing features against each other.
4. Present, support and attack positions in an argument (e.g., by testing consequences of a tentative conclusion, pressing an assertion to its limits and exploring the meaning of a concept.)
5. Control the course of an argument (e.g., by focusing attention of participants in a discussion on particular issues.)
6. Explain the meaning of a statute or rule by augmenting an existing case base with meaningful test or training cases.

Relating Fact Situation to Past Cases

A good example primarily of the first purpose of hypotheticals, to relate a fact situation to past cases, is found in the oral argument of *Lynch v. Donnelly*, 104 S.Ct. 1355 (1984), a case involving the constitutionality of the Christmas creche display of a city on municipal land, Justices posed the following hypotheticals⁵:

To the attorney for the City:

Q: Do you think ... that a city could display a nativity scene alone without other displays such as Santa Claus and Christmas trees...?

Q: [C]ould the city display a cross for the celebration of Easter, under your view?

To the attorney opposing the display:

Q: [S]upposing the creche were just one ornament on the Christmas tree and you could hardly see it unless you looked very closely, would that be illegal?

Q: What if they had three wisemen and a star in one exhibit, say? Would that be enough? ... What if you had an exhibit that had not the creche itself, but just three camels out in the desert and a star up in the sky?

Q: Well, the city could not display religious paintings or artifacts in its museum under your theory.

Q: There is nothing self-explanatory about a creche to somebody ... who has never been exposed to the Christian religion.

Q: Would the display up on the frieze in this courtroom of the Ten Commandments be unconstitutional then, in your view?

Q: Several years ago ... there was a ceremony held on the Mall, which is federal property of course. ... [T]here were 200,000 or 300,000 people ... and the ceremony was presided over by Pope John Paul II. Would you say that was a step toward an establishment of religion violative of the religion clauses? ... Then you think it would be all right to put a creche over on the Mall? ... How do you distinguish a high mass from

⁵The issue was the constitutionality of the creche under the First Amendment of the United States Constitution which says that "Congress shall make no law respecting an establishment of religion, or prohibiting the free exercise thereof."

a creche? ... [T]here was a considerable involvement of government in that ceremony, hundreds of extra policemen on duty, streets closed for traffic control purposes, and all that sort of thing. That was a considerable governmental involvement, was it not? [*SUP Lynch v. Donnelly*, Case No. 82-1256, Fiche No. 5, pages 9,11,32,37-45].

In the above questions, one can see the Justices modifying the fact situation along various dimensions: changing the location, focus, size, and symbolic religious content of the display, the nature of the viewer, and the degree of government involvement.

The purpose of some of the modifications is to compare the fact situation to actual cases previously decided by the court to test whether the current situation presents stronger or weaker facts.⁶ Each of the cases cited in the footnote has facts similar to those of the hypotheticals posed by the Justices. One may infer that the Justices had those specific cases in mind from the fact that they were cited in various of the appellate briefs with which the Justices would be familiar by the time of the oral argument [Kurland and Casper, 1985]. The last hypothetical, regarding the Pope's mass, is interesting because there the actual "case" is significant because it did *not* give rise to litigation.

Argument Testing and Rhetorical Uses of Hypotheticals

Hypotheticals are also used as analytical and rhetorical tools to test the consequences of a proposed holding, test the limits of a definition, to simplify complicated fact situations for analysis and as rhetorical tools to control argument.

⁶See e.g., *Stone v. Graham*, 449 U.S. 39 (1980): Posting copies of Ten Commandments in schools held unconstitutional; *Gilfillan v. City of Philadelphia*, 637 F. 2d 924 (CA3, 1980): City-financed platform and cross used by Pope John Paul II to celebrate public mass held unconstitutional; *McCreary v. Stone*, 575 F.Supp. 1112 (SDNY 1983): Not unconstitutional for village not to refuse permit to private group to erect creche in public park.

Frequently, the Justices use the hypothetical to apply pressure to the rule proposed by an attorney for deciding the case. That can be seen in the Mall example above and in the following example from *New Jersey v. T.L.O.*, 105 S.Ct. 733 (1985), a case involving the constitutionality of a high school vice principal's search of a female student's handbag for cigarettes after a teacher reported that she had been smoking in the girls room. A Justice asked:

Q: Do you think then that a male teacher could conduct a pat-down search of a young woman at age sixteen to find the cigarettes?

In response, the attorney for the state took the position that the Fourth Amendment of the United States Constitution, which has been interpreted as prohibiting unreasonable searches by law enforcement authorities, does not apply to high school administrators. The Justice rejoined:

Q: And does that mean that their authority then to make searches, if the Fourth Amendment is completely inapplicable, extends to any kind of search, strip search or otherwise? [*SUP New Jersey v. T.L.O.*, 1984 Term, Fiche No. 5, pages 13-22].

In the argument of *Sony Corp. v. Universal City Studios*, 464 U.S. 417 (1984), while an attorney was advocating the plaintiff's position that if Sony sold video recorders while knowing that consumers would use them to copy copyrighted materials, then Sony should be legally responsible to the owners of the copyrights, the following interchange occurred ⁷:

Q: Suppose ... that about ten percent of all programming could be copied without any interference by the producer or whoever owned the program....

⁷The technical issue was whether Sony was liable for contributory infringement (i.e., responsible for someone else's direct copyright infringement) despite the fact that the recorders had a "substantial noninfringing use" (i.e., were capable of being used without necessarily infringing someone's copyright.)

A: I don't think that would make any difference. I think ten percent is too small of an amount.

Q: Well, what about 50?

The attorney for the Studios asserted that even if there were only one television program that was copyrighted, if Sony knew the program would be copied, it would be legally responsible. Finally, the Justice asked:

Q: Under your test, supposing somebody tells the Xerox people that there are people who are making illegal copies with their machine and they know it. ... But your view of the law is that as long as Xerox knows that there's some illegal copying going on, Xerox is a contributory infringer?

A: To be consistent, Your Honor, I'd have to say yes.

Q: A rather extreme position. [*SUP Sony Corp. v. Universal City Studios*, Case No. 81-1687, Fiche No. 2, pages 21-25].

In the last two examples, although the altered fact situations posed by the Justice are still covered by the proposed rule, it is progressively harder for the attorney to justify applying the rule to the hypotheticals because the latter present progressively weaker facts. The Justice "stacks" the hypothetical with more extreme facts that weigh against the party in the hypothetical who corresponds to the attorney's client. The attorney is forced to distinguish the hypothetical, to come up with some alternative explanation for why the hypothetical and the current fact situation need not be decided the same way. The pressure on the attorney to distinguish is especially strong if the hypotheticals are closely based on real cases that the Court has decided, or for which there are strong reasons to decide, contrary to the way it would be decided if the proposed rule were followed.

Like the Justices and arguers before the Court, HYPO poses hypotheticals to compare a fact situation to past precedents and to show how arguments can be strengthened and weakened. See Chapters 4, 5 and 8. In fact, HYPO's model of

dimensions and heuristics for building hypotheticals are general enough to analyze the sequence of hypotheticals in the *Lynch* and *Sony* cases. See Chapter 8. Also as described in Chapter 8, HYPO paves the way for employing hypotheticals as test cases.

3.4 Analogies in Law

Having described the importance of arguing by analogy to cases and hypotheticals, let us briefly examine the jurisprudential debate about the nature of analogical legal reasoning. The reader who wishes to learn more about HYPO may skip the remainder of this chapter and proceed directly to Chapter 4.

As described in [Burton, 1985, page 40], what might be called the standard model of analogical legal reasoning requires three steps:⁸

- (1) identifying a proper base point, or precedent,
- (2) identifying factual similarities and differences between a base point and a problem situation, or analyzing the facts to compare and contrast the precedent with the problem case,
- (3) determining whether the factual similarities or the differences are more important under the circumstances, or deciding whether to follow or distinguish the precedent.

⁸The most famous account of analogical legal reasoning is in [Levi, 1949]. Although Levi characterizes the second and third steps as a process of identifying in the precedent the "inherent" rule of law that is applied to the second case he also says that "[i]n an important sense legal rules are never clear," [Levi, 1949, page 1], and that "[t]he rules change as the rules are applied. More important, the rules arise from a process which, while comparing fact situations, creates the rules and then applies them." [Levi, 1949, page 3-4]. Other accounts are referred to in [Wellman, 1985].

The standard model of analogical reasoning in law has been criticized on two scores:

First, the account does not provide guidance for determining in Step (3) what similarities and differences are more important.⁹

Second, the account fails to specify how one evaluates competing analogies.¹⁰

HYPO's model of analogical legal reasoning meets both of the above criticisms of the traditional model of analogical legal reasoning:

First, it provides a justifiable means for specifying what similarities and differences are more important:

1. The set of similarities and differences that *may* be important are represented by the dimensions. For each dimension, there is at least one case where a court said that the feature associated with the similarity or difference was important and decided the case either because, or in spite, of that feature. The fact that a similarity or difference is important is justified by citing that case.
2. HYPO dynamically determines which of these similarities and differences, in fact, *are* more important with respect to any particular problem situation by

⁹[Burton, 1985, page 40] says: "But the crucial third step in such reasoning is left unguided. Judging what facts are more important under the circumstances remains mysterious activity, subject to little apparent governance by the analogical form or the rules of the common law."

¹⁰[Wellman, 1985, page 83] says: "What makes an analogical argument valid? What are the criteria by which we could evaluate any given use of analogy by a judge? Consider the situation in which a problematic legal dispute is similar to two (or more) different precedents. There is some analogy to be drawn between the case at hand and each of the precedents. Which analogy is preferable?"

identifying the most analogous cases and noting configurations of counter-examples among them or the absence of such configurations. The features that the most analogous cases and their counter-examples share with the problem situation and the differences among them with respect to features shared with the problem situation are the most important similarities and differences relative to that particular problem situation.

Second, it follows that there are criteria in HYPO's account of analogical legal reasoning for evaluating competing analogies. The specific criteria for evaluation of arguments – including criteria for choosing among the most analogous precedents – are presented in Chapter 4. The criteria prefer cases that are more on point to the problem situation. The competing precedents are counter-examples either more or less on point or extreme than a given precedent. Arguments citing precedents for which there are no more on point counter-examples are given the highest preference.

Although HYPO's approach to identifying important similarities and differences may not, at first glance, seem philosophically very satisfying, consider the alternatives. An alternative answer to the first criticism that does seem to have philosophical appeal is that judges do or should resort to generally agreed-upon legal rules or principles to determine what similarities and differences are more important in drawing the analogy. [Dworkin, 1977] describes a coherence view of legal reasoning that posits the existence of generally agreed-upon principles – the principles that best justify existing precedents – which are worked into a general theory that can be used to decide novel disputes. Rawls presents a similar coherence theory of moral reasoning in [Rawls, 1971]. See the characterization of Dworkin's and Rawls' theories as coherence theories in [Stick, 1986, notes 43, 66]. Coherence theories are interesting in that they anticipate that the general principles will conflict in specific fact situations, that at least some of the principles will be modified in light of those conflicts and that some cases will simply be decided

wrongly. Coherence theories do not necessarily involve analogical reasoning – Dworkin believes that the resulting general theory is sufficient to lead the judge to the one right answer in any legal case [Dworkin, 1978] – but they do suggest an answer to the first criticism. The antecedents of the possibly conflicting general principles would focus the judge on particular features of the cases that are the basis of similarities and differences most significant in light of the principles.

The problem with this view is that in the context of a law suit, even a generally-agreed upon principle will not be agreed to by the party against whom it is going to be used. What is the principle? How can one tell? What does it mean? How does it apply in the problem situation? The parties will have to make arguments to the judge justifying that a particular principle should or should not be relied upon in determining what similarities and differences are more important in the problem situation.

The preferred way to make those arguments is to cite and distinguish yet other cases where a previous court said that it applied the given principle in determining that particular similarities or differences were more significant and to argue by analogy that the same principle should be applied in the current case. But that means one again must draw an analogy between the current fact situation and those other cases – which involves us in the same question of how to determine what similarities and differences are more important for drawing those analogies – an infinite regress.

When dealing with justifications, one has to start somewhere. Generally accepted principles are an option, but where, as in law, the meanings of the principles are not well-defined except by reference to the cases decided under them, a different starting point is necessary. HYPO starts with precedential justifications that are expressed at the same factual level in which the cases are described, that is, at a level of factual description for which even attorneys do not need to cite yet other cases in support of an assertion.

This dissertation is about the case-based adversarial process as actually performed in legal arguments. Its assumptions about the importance of similarities and differences and criteria for evaluating legal arguments are empirically realistic simplifications that allow a computer program, in a legally reasonable way, to:

- Justify conclusions by citing analogous cases and drawing simple analogies.
- Respond to the justifications by distinguishing and citing counter-examples and in some circumstances,
- Determine who has the stronger argument.

Undoubtedly fundamental legal principles play a role in the real-life process of legal analogical reasoning. One sees them invoked in legal arguments all the time and their use in case-citing arguments is complex and pervasive.¹¹ But one cannot hope to model that kind of adversarial reasoning until one understands the simpler analogical comparisons among precedents that are the subject of this dissertation.

¹¹Extending HYPO to deal with more abstract legal predicates like those used in principles, rules of law, etc. is considered in Chapter 12.

On a claim for TRADE-SECRETS-MISAPPROPRIATION,
both sides can make a strong argument.

PLAINTIFF can cite the following cases
for which there are
no more on point counter-examples:

Structural Dynamics Research Corp. V. Engineering Mechanics Research Corp.
401 F. Supp. 1102 (E.D.Mich., 1975)

DEFENDANT can cite the following cases
for which there are
no more on point counter-examples:

Amoco Production Co. V. Lindley
609 P.2d 733

Figure 1: HYPO's Citation Summary for *Amexco* Fact Situation

==> POINT for PLAINTIFF as Side-1:

WHERE:

Plaintiff and defendant entered into a nondisclosure agreement.

EVENTHOUGH:

Employee defendant was sole developer of plaintiff's product.

PLAINTIFF should win a claim for TRADE-SECRETS-MISAPPROPRIATION.

CITE: Structural Dynamics Research Corp. V. Engineering Mechanics Research Corp.

401 F. Supp. 1102 (E.D.Mich., 1975).

<== RESPONSE for DEFENDANT as Side-2:

Structural Dynamics Research Corp. V. Engineering Mechanics Research Corp.
is distinguishable because:

In Structural Dynamics, defendant received something of value for entering into the agreement. Not so in Amexxco.

In Structural Dynamics, plaintiff's former employee brought product development information to Defendant. Not so in Amexxco.

In Structural Dynamics, the nondisclosure agreement specifically referred to plaintiff's product. Not so in Amexxco.

==> REBUTTAL for PLAINTIFF as Side-1:

None.

**Figure 2: Excerpt from HYPO's 3-Ply Arguments for
Amexxco Fact Situation**

==> POINT for DEFENDANT as Side-1:

WHERE:

Employee defendant was sole developer of plaintiff's product.

EVENTHOUGH:

Plaintiff and defendant entered into a nondisclosure agreement.

Plaintiff adopted security measures.

DEFENDANT should win a claim for TRADE-SECRETS-MISAPPROPRIATION.

CITE: Amoco Production Co. V. Lindley
609 P.2d 733.

<== RESPONSE for PLAINTIFF as Side-2:

None.

==> REBUTTAL for DEFENDANT as Side-1:

None.

**Figure 3: Excerpt from HYPO's 3-Ply Arguments for
Amerxco Fact Situation**

PLAINTIFF's position would be strengthened in following situations:

SUPPOSE:

Defendant's access to plaintiff's product information saved it time or expense.
Plaintiff's former employee brought product development information to defendant.

Cf. *Analogic Corp. V. Data Translation, Inc.*
358 N.E.2d 804 (S.J.C., Mass., 1976)

Defendant's access to plaintiff's product information saved it time or expense.
Defendant paid plaintiff's former employee to switch employment.
Plaintiff's former employee brought product development information to defendant.

Cf. *Space Aero Products Co. V. R.E. Darling Co.*
208 A.2d 74 (Ct.App., Md., 1965)

Defendant's access to plaintiff's product information saved it time or expense.
Defendant paid plaintiff's former employee to switch employment.

Cf. *Telex Corp. V. Ibm Corp. (1)*
510 F.2d 894 (10 Cir., 1975)

Plaintiff's former employee brought product development information to defendant.

Cf. *Structural Dynamics Research Corp. V. Engineering Mechanics Research Corp.*
401 F. Supp. 1102 (E.D.Mich., 1975)

**Figure 4: Excerpts from HYPO's Suggested Hypotheticals
for Amexco Fact Situation**

CHAPTER 4

The HYPO Program: an Overview

HYPO is a computer program for representing and applying case precedents and hypothetical cases to assist an attorney in evaluating and making arguments about a new fact situation. HYPO performs case-based reasoning and, in particular, models legal argument in the domain of trade secrets law. HYPO's key elements include:

1. **CKB:** a structured case knowledge base ("CKB") of actual legal cases;
2. **Dimension Index:** an indexing scheme ("dimensions") for retrieval of relevant precedents from the CKB;
3. **Dimensional Analysis:** methods for analyzing a current fact situation ("cfs") and retrieving relevant cases from the CKB;
4. **Positioning:** methods for "positioning" the cfs with respect to relevant precedent cases in the CKB and finding the most on point cases ("most-on-point cases");
5. **Comparing/Contrasting:** methods for comparing and contrasting cases (e.g., citing, distinguishing, finding counter-examples);
6. **Posing Hypotheticals:** methods for perturbing the current fact situation to generate hypotheticals that test the sensitivity of the cfs to changes,

particularly with regard to potentially adverse effects of new damaging facts coming to light and existing favorable ones being discredited;

7. **3-Ply Arguments:** methods for generating "3-ply" argument outlines to dry run and debug a legal argument and to characterize the strength of available precedents using citation labels in a manner familiar to attorneys;
8. **Explanation:** a framework for explaining a decision and its alternatives by citing precedents as examples, critically comparing the precedents' strengths using 3-ply arguments, and posing hypothetical variations of the current fact situation and precedents to demonstrate critical features, which if different, would lead to different conclusions.

4.1 Knowledge Sources in HYPO

HYPO has four main sources of legal knowledge:

1. **Case Representation Language:** a two-tiered language for representing legal cases comprising:
 - (a) "Legal-Case-Frames";
 - (b) "Factual Predicates".
2. **Case Knowledge Base:** a CKB for collecting and organizing actual and hypothetical legal cases.
3. **Dimensions:** a library of dimensions that are the principal index to the Case Knowledge Base.
4. **Argument Evaluation Standards:** jurisprudential standards for evaluating arguments citing cases.

Legal-Case-Frames are the basic language for representing cases in HYPO. Actual legal cases in HYPO's Case Knowledge Base, current fact situations presented by an attorney as inputs to HYPO, and hypothetical cases generated by HYPO are all expressed in the legal-case-frame language. Each case has:

1. A top level legal-case-frame (a "CASE" frame) for representing information about the case including its name, citation information, the parties to the dispute and their roles as plaintiff or defendant, what claims were raised, and how the case was decided.
2. Underlying legal-case-frames for representing the facts of the case including those objects and relations important in the trade secrets and contracts legal domains such as the parties' products, employees, changes in employment, agreements, product related information, disclosures, etc. Figure 5 shows a complete listing of the legal-case-frames to date.

All legal-case-frames for a particular case have a pointer to the instantiated top level CASE frame. For current fact situations entered by the user and hypotheticals generated by HYPO, the top-level CASE frame will be mostly blank reflecting the fact that those cases have not actually been decided by a court.

Factual predicates are a second language for summarizing the facts of a case represented by the underlying legal-case-frames. They are generalized factual statements that confirm whether or not certain legally significant relationships are true in the case (e.g., there-exist-disclosees, employee-has-switched-employers). Factual predicates are used primarily in dimensional analysis of a fact situation. A complete list of all of the factual predicates is shown in Appendix I.

The **Case Knowledge Base** contains 30 actual and hypothetical legal cases. All of the cases are represented in legal-case-frames. The top level CASE frames of the actual cases contain information about the legal claims raised in the case and

Legal:

CASE TYPE-OF-CLAIM
 PARTY-TO-LAWSUIT PERSON-PARTY
 CORPORATE-PARTY EMPLOYEE-PARTY

Actors:

PERSON CORPORATION

Product-related:

PRODUCT KNOWLEDGE
 PRODUCT-WORKED-ON INTRINSIC-SIMILARITIES
 SECURITY-BREACH DISCLOSURE-EVENT

Employment-related:

EMPLOYEE EMPLOYMENT
 EMPLOYMENT-CHANGE

Contracts:

AGREEMENT NONCOMPETITION-COV
 NONDISCLOSURE-AGREEMENT
 PROMISE RELIANCE

Figure 5: Legal-Case-Frames

who won. The cases involve claims for trade secrets misappropriation, breach of nondisclosure/noncompetition agreements or breach of other kinds of contracts. Appendix G lists all of the cases in the CKB.

Dimensions represent the features of a legal case that are important for the strength of a plaintiff's position on a particular kind of claim. They represent the legal relationship between various clusters of operative facts and the legal conclusions they support or undermine. Dimensions capture:

1. Relevant features for determining the similarities and differences between cases that are important for a claim.
2. Information about how a feature "cuts", whether or not it favors the plaintiff's position in a particular claim.

3. **Why the feature matters.** It matters because in some prior case, a court identified the feature as supporting or not supporting its decision for a particular side.
4. **Information about the magnitude of the feature in the case,** how extreme or mild it can be in favor of the plaintiff or defendant.

Dimensions are an index into cases in the Case Knowledge Base that are relevant precedents for justifying an argument that a side in a fact situation with the same features should win a claim. They also provide a scale for comparing cases in terms of magnitudes of the features that affect the strength of the argument. Appendix H summarizes the thirteen implemented dimensions. Each dimension has:

1. **Prerequisites,** lists of factual predicates that must be satisfied in a case for the dimension to apply to the case;
2. **Focal slots** that single out the particular facts making a case stronger or weaker for the plaintiff along the dimension;
3. **Range information** that tells how a change in the focal slot values affects the strength of the plaintiff's position along the dimension.

Argument Evaluation Criteria allow HYPO to make certain judgements about the strength of case-based arguments in favor of or against the plaintiff by comparing the precedential justifications that can be marshalled on either side. Although the Criteria, set forth in Figure 6, are not strong enough to determine a winner of a case (probably no criteria are strong enough for that), they are strong enough to select and order the precedents to show the user. HYPO uses this information to prompt steps to shore up a weak argument or find a defense to a strong one by posing appropriate hypotheticals and questions to the attorney.

1. **Minimum criteria for citing a precedent:**
To be “citable” in support of legal conclusion that a side in a fact situation should win a claim, a precedent should:
 - Involve the same claim;
 - Have been won by that side;
 - Be relevantly analogous;
 - Have not been overruled.
2. **Comparing precedents in terms of how on point they are:**
If precedent[a] is more on point than precedent[b] then precedent[a] is better.
3. **Comparing precedents in terms of how distinguishable they are:**
If precedent[a] and precedent[b] are equally on point and precedent[a] is not distinguishable, precedent[a] is better.
4. **Comparing points and responses:**
A response that cites a more-on-point counter-example is stronger than: a) the point to which it responds (i.e., the “trumped” point); b) a response to the same point that does not.
5. **Comparing points:**
A point to which there is no response citing a more-on-point counter-example (i.e., a “non-trumped” point) is stronger than one to which there is.
6. **Minimum criteria for reasonable argument on claim:**
There must be at least one non-trumped point for a side on the claim. (There may, however, be a response citing an as-on-point counter-example.)
7. **Improving an argument**
The more non-trumped points the better for a side’s argument.
8. **Comparing opposing sides in one argument:**
If all of the non-trumped points favor Side-1, and there are no non-trumped points for Side-2, Side-1’s argument is stronger.
9. **Comparing same side in two arguments:**
If there are more non-trumped points favoring Side-1 in Argument[b] than in Argument[a], Argument[b] is stronger for side-1 than Argument[a].

Figure 6: Argument Evaluation Criteria

4.2 HYPO's Reasoning Process

The **input** to HYPO is a current fact situation expressed in the legal-case-frame language. The current fact situation describes a dispute between parties involving trade secret information or breaches of nondisclosure and noncompetition agreements.

HYPO's **output** is an explanation consisting of 3-ply arguments and hypotheticals that show the attorney the following information:

1. **Best Precedents to Cite in Legal Argument:** For each claim for which there are good precedents to cite, the Citation Summaries and 3-ply arguments show what the best precedents are to cite in points in a legal argument for and against the plaintiff's position. The relative strengths of the parties' positions are compared.
2. **Points Citing the Precedents and Responses:** For each of the best precedents, and for any cases selected by the attorney, the program shows how to make a point citing the case in a legal argument about the current fact situation and how an opponent would respond to the point.
3. **Suggested Hypotheticals to Strengthen or Weaken Legal Argument:** Suggested hypothetical variations of the current fact situation are posed, and 3-ply arguments generated for those variants, which when compared to the original 3-ply arguments, show the attorney how a point or response can be strengthened by the addition or subtraction of crucial facts.

HYPO's **reasoning process** for generating the outputs corresponds closely to the adversarial, case-based reasoning process described in Chapter 2. The steps are:

1. Dimensionally analyze the current fact situation.
2. Retrieve relevant precedent cases from CKB.
3. "Position" cfs with respect to retrieved cases.
4. Compare cases and select best precedents.
5. Generate 3-ply arguments for cfs citing precedents.
6. Heuristically (hypothetically) modify cfs.
7. Generate 3-ply arguments for hypotheticals.
8. Explain by illustrating arguments and comparing arguments for cfs and hypotheticals.

4.3 HYPO's Architecture

4.3.1 Introduction to HYPO's Component Modules

The HYPO program is divided up into modules that perform the basic steps of its reasoning process. The modules comprise:

1. **CASE-ANALYZER:** to perform a dimensional analysis of a current fact situation to determine what cases are relevant to the situation.
2. **CASE-POSITIONER:** to retrieve relevant cases from the CKB and to organize the retrieved cases according to how on point they are with respect to the current fact situation.

3. **BEST-CASE-SELECTOR:** to select from the positioned relevant cases the most on point cases for the plaintiff and defendant as well as cases that potentially are most on point.
4. **3-PLY ARGUER:** to generate 3-Ply Arguments consisting of points, responses and rebuttals using the most on point cases and cases selected by the attorney as examples and counter-examples in a legal argument.
5. **HYPO-GENERATOR:** to generate hypothetical variants of the current fact situation to bolster points and responses or generate new ones.
6. **EXPLAINER:** to summarize the cases that can be cited in favor of a position, to characterize how strongly they support the position, to focus the attorney's attention on the most significant cases and hypotheticals including those that the user may wish to have HYPO analyze and interpret for the sake of comparison, and to facilitate comparing arguments between cases and hypotheticals that HYPO has analyzed and interpreted.
7. **SESSION MANAGER:** to facilitate the attorney's selection or generation of cases to use as a current fact situation or to save cases or hypotheticals in the CKB.
8. **CASE EDITOR:** to assist the attorney to input new fact situations, modify existing fact situations, or permanently store a fact situation in the CKB.

4.3.2 Flow of Control in HYPO

The flow of control in HYPO consists of recursive runs through the "basic processing loop" in a single "session". In the **basic processing loop**, a single current fact situation undergoes dimensional analysis, positioning, best case selection and argument generation. The basic processing loop is the main loop

shown in Figure 7, a schematic diagram of the flow of control through HYPO's modules. A session with HYPO consists of multiple recursions through the basic processing loop. On each recursion, the current fact situation may be the same fact situation, a hypothetical variant of a fact situation previously analyzed in the session, or a different case from the CKB.

In the remainder of this section, we will describe the control steps of the basic processing loop and recursions and introduce the basic data structures employed in those steps. In the next section, we will examine the modules and the basic data structures in greater detail.

4.3.3 The Basic Processing Loop

The flow of control and information through the session and through each basic processing loop in a session starts with the SESSION MANAGER through which the user selects a current fact situation. The cfs may be a case from the CKB, a new case entered by the user through the use of the menu driven CASE EDITOR, or a hypothetical variant of the cfs previously generated by HYPO in the session. The SESSION MANAGER creates a "case-analysis-record" for the current fact situation. The case-analysis-record is the basic data structure for storing information about the results of the analysis and interpretation of the current fact situation produced in the basic processing loop. The SESSION MANAGER keeps track of this and all the case-analysis-records for a session.

Upon receiving a new cfs, the CASE-ANALYZER performs a dimensional analysis of the current fact situation. The CASE-ANALYZER determines what factual predicates are satisfied by the cfs and records that information in an "interpretation-frame" which is stored in the case-analysis-record. An interpretation-frame is the basic data structure for summarizing the values of all factual predicates for a particular case. Using the information contained in the

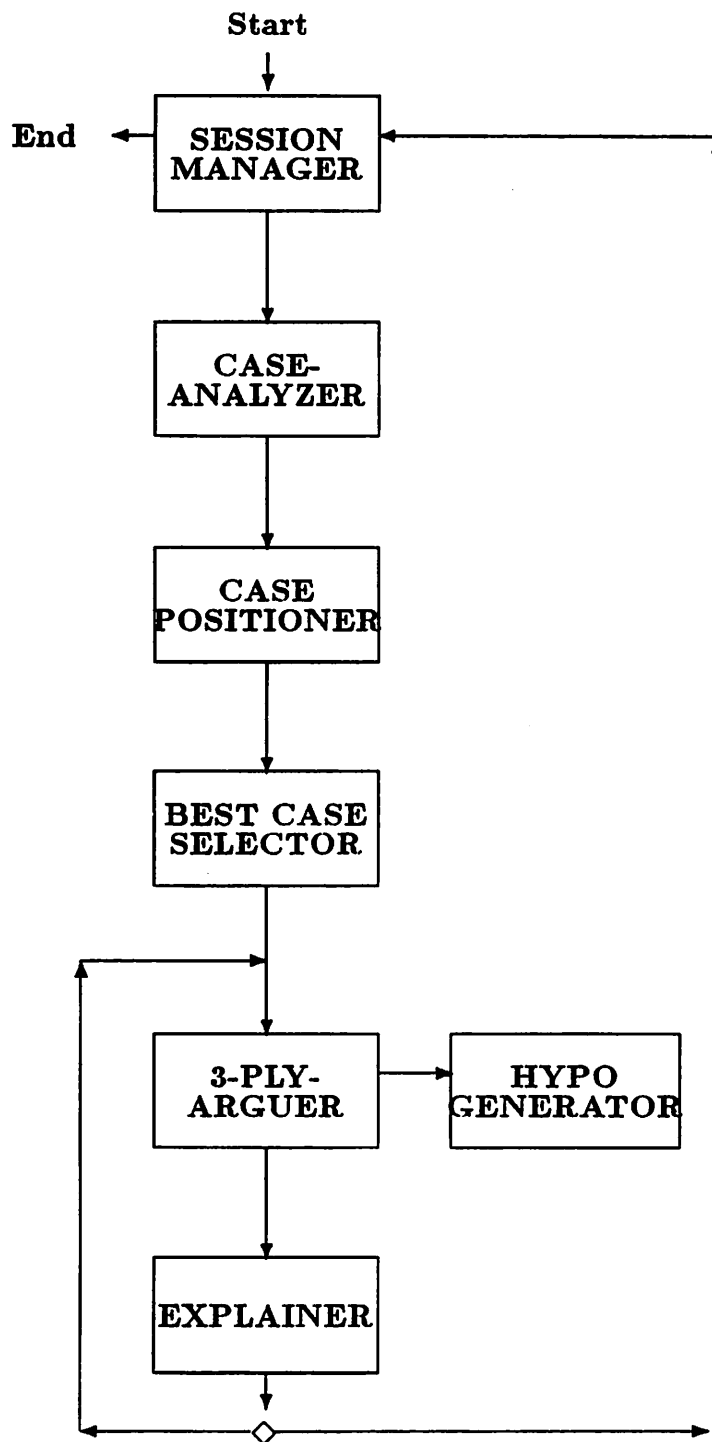

Figure 7: Basic Processing Loop

interpretation-frame, the CASE-ANALYZER determines which dimensions' prerequisites are satisfied by the current fact situation. A dimension is applicable if all of its prerequisites (which are expressed in terms of lists of factual predicates) are satisfied. It is a near-miss if all but certain designated triggering prerequisites are satisfied. The applicable and near-miss dimensions are recorded in the appropriate slots of the case-analysis-record.

Using the list of applicable and near-miss dimensions in the case-analysis-record, the CASE-POSITIONER retrieves any case in the CKB indexed by any of the applicable or nearly applicable dimensions. These cases are, to a first approximation, all of the cases in the CKB that are relevant for the analysis of the current fact situation. The CASE-POSITIONER then organizes those cases in "claim-lattices". A claim-lattice is the basic data structure for organizing the relevant cases according to how on point they are relative to the current fact situation, more specifically, how great the overlap is between dimensions that apply to the case and that apply or nearly apply to the cfs.

Once claim-lattices are created, it is a simple matter for the BEST-CASE-SELECTOR to choose the "most-on-point cases". The most-on-point cases are the cases in the claim-lattice that have the greatest overlap of applicable dimensions with the current fact situation. The BEST-CASE-SELECTOR sorts the most-on-point cases by the winner, either the plaintiff or the defendant. Depending on who won, the most-on-point cases are the best cases to cite in support of a particular side in the current fact situation or the most troublesome cases for that side. The BEST-CASE-SELECTOR also selects the "potential most-on-point cases". Potential most-on-point cases have the greatest overlap of applicable and near-miss dimensions with the current fact situation. Depending on who won a potential most-on-point case and its relative position with respect to most-on-point cases, it may be the basis of a useful hypothetical variant of the cfs. The most-on-point cases are recorded in the appropriate slots of the

case-analysis-record.

Using the claim-lattices and best case information, the 3-PLY-ARGUER generates "argument-records". An argument-record is a blueprint for constructing a 3-ply argument.¹ It is the basic data structure for recording information about how to:

1. Cite a case in a legal point for a side in the current fact situation by drawing an analogy between the two;
2. Respond to that point on behalf of the opposing side by distinguishing the case and citing counter-examples.
3. Pose hypothetical variations of the current fact situation that would strengthen the point or the response.

A 3-ply argument is constructed by presenting the information in an argument-record in a 3-ply, turn-taking model of a:

1. Point for one side;
2. Response to the point on behalf of the opposing side;
3. Rebuttal for the first side.

The 3-PLY ARGUER automatically generates arguments for the most on point cases for each claim. It also offers to allow the attorney to select cases with which HYPO makes and responds to points. All of the argument-records are also recorded in the case-analysis-record.

¹Theoretically the exchange of point, response, rebuttal could go on for many ply, but in legal practice, the sequences tend to be shallow; three ply is usually the limit.

The 3-PLY-ARGUER calls on the HYPO-GENERATOR to pose hypothetical variants of the cfs that could bolster certain points or responses or generate new points. The HYPO-GENERATOR uses specifications derived by the 3-PLY-ARGUER from the claim-lattices and a set of heuristics to generate legally relevant hypotheticals. The specifications tell the HYPO-GENERATOR to make a variant of the current fact situation that is more like a selected potential most-on-point case. The hypothetical will become the subject of a subsequent recursive call through the basic processing loop.

The EXPLAINER module has access to all the case-analysis-records generated in a session. For a given current fact situation, it explains the strengths and weaknesses of a side's position by:

1. Demonstrating the 3-ply arguments.
2. Summarizing the best cases' significance in a manner familiar to attorneys by applying "citation labels".
3. Posing hypotheticals to show how particular points/responses can be bolstered and how to make new points.
4. Comparing 3-ply arguments for other hypotheticals and cases analyzed during the session.

Depending on choices made by the attorney at the prompting of the EXPLAINER, the basic processing loop is called recursively on hypothetical variations of the current fact situation or on other cases.

4.4 Detail of HYPO's Modules

4.4.1 SESSION MANAGER

The main task of the SESSION MANAGER is to maintain the master list of all of the case-analysis-records generated during a single session. The ***session-master*** is the repository for the case-analysis-records of all of the fact situations that were the current fact situation during some previous run through the basic processing loop in a given session.

The SESSION MANAGER starts a current fact situation down its path through the basic control loop. The results of the actions of the CASE-ANALYZER, CASE-POSITIONER, BEST-CASE-SELECTOR, and 3-PLY-ARGUER will all be stored in the case-analysis-record for the cfs. Figure 8 shows the slots of a case-analysis-record and a short description of what information they contain.

4.4.2 CASE-ANALYZER

The CASE-ANALYZER performs a dimensional analysis of the current fact situation. The input to the module is the current fact situation represented in the legal-case-frame representation language and a "blank" case-analysis-record. The output is a partially filled in case-analysis-record containing the satisfied factual predicates and applicable and near-miss dimensions. If all of a dimension's prerequisites are satisfied in a fact situation except certain triggering prerequisites, the dimension is a **near-miss**. The **triggering prerequisites** for each dimension are those associated with the dimension's focal slots, the slots that locate the fact situation somewhere along the dimension's range.

The steps of the dimensional analysis process are as follows:

1. Make and fill out a new interpretation-frame for the case and put it in the

- : **case**
Pointer to the case or fact situation being analyzed.
- : **needs-analysis**
T if any changes to facts of case have been made.
- : **interp-frame**
Pointer to interpretation-frame setting forth values for factual predicates.
- : **applicable-dimensions**
List of all dimensions all of whose prerequisites are satisfied.
- : **near-miss-dimensions**
List of all dimensions all of whose prerequisites are satisfied except triggers.
- : **excluded-dimensions**
List of all dimensions any of whose prerequisites are negated.
- : **possible-claims**
List of claim-lattices for all claims for which related dimensions apply or are near-misses.
- : **most-on-point-cases-by-claim**
List of most-on-point cases sorted by claim and side (Π or Δ).
- : **most-on-point-near-miss-cases-by-claim**
List of potential most-on-point cases sorted by claim and side (Π or Δ).
- : **best-cases-by-claim**
List of most-on-point cases that are citable for side in the first instance.
- : **points**
List of all argument-records generated for case.

Figure 8: Case-Analysis-Record

case-analysis-record.

2. For each factual predicate in HYPO:
 - (a) Apply "retrieval" method associated with the factual predicate to the legal-case-frames for the cfs.
 - (b) Store the answer in interpretation-frame (i.e., T or appropriate value, NIL, *negative*).
3. Get list of all dimensions in HYPO to determine if they are applicable or near-misses. For each dimension:
 - (a) Get dimension's lists of prerequisites and triggering prerequisites from dimension's prerequisites slots.
 - (b) From interpretation-frame, generate list of unknown and negated factual predicates (i.e., factual predicates whose values are NIL or *negative*) in the cfs.
 - (c) Compare dimension's prerequisites lists with list of unknown and negated factual predicates. Dimension is **applicable** if and only if prerequisites list and unknowns-and-negated-predicates list are disjoint. Dimension is **near-miss** if and only if the dimension is not applicable and the set-difference of the prerequisites list and the unknowns-and-negated-predicates list is a subset of the dimension's triggering prerequisites (i.e., the only unsatisfied prerequisites are triggering prerequisites.)
 - (d) If dimension applies or is a near-miss, store in the appropriate slot of case-analysis-record.

The interpretation-frame stores the values of the factual predicates for a particular case. The interpretation-frame is a flavor instance most of whose slots correspond to factual predicates. Figure 9 shows excerpts from an interpretation-frame.² Each item below the ":case" slot consists of:

1. a factual predicate,
2. an English statement of the generalized fact represented by the predicate,
and

²A complete listing of factual predicates is shown in Appendix I.

3. in parentheses, the possible values of the predicate. The possible values are:

- NIL indicating that the fact is unknown in the case;
- *negative* indicating that the fact is false in the case; and
- T or some other special value indicating that the fact is true and providing some additional information such as the legal-case-frame or a list of slot-values from a legal-case-frame, that makes the fact true.

HYPO draws inferences about what factual predicates are satisfied by a case by using retrieval methods associated with each predicate. Retrieval methods move from the legal-case-frame representation of the cfs to a filled out interpretation-frame ("store" methods go in the opposite direction). A retrieval method associated with a particular factual predicate contains an instruction for determining the value of the factual predicate. The instruction involves testing the cfs for:

1. Particular Collections of instantiated legal-case-frames;
2. Case-frame slot values within certain ranges;
3. Cross-references among the case-frames.

As per the instruction, the retrieval method searches the "*global-catalog*" for the required case frames and tests the slot values. The *global-catalog* contains pointers by type to all of the instantiated legal-case-frames (and all other HYPO objects). The retrieval method finds the requisite case frames by searching the appropriate typed lists in the *global-catalog* for the objects that point to the top-level CASE frame of the cfs.

- : case**
Pointer to the case or fact situation being analyzed.
- : claimant-makes-product1**
Corporate Π makes a product.
(NIL, PRODUCT, *negative*)
- : exists-claimants-info-re-product1**
 Π has product information.
(NIL, KNOWLEGE, *negative*)
- : corps-1-2-compete-re-products-1-2**
Corporate Π and Δ products compete.
(NIL, T, *negative*)
- : exists-employment-change**
Employee Δ worked for Π before working for corporate Δ .
(NIL, EMPLOYMENT-CHANGE, *negative*)
- : employee-paid-to-switch**
Employee Δ received bribe to switch employment.
(NIL, list of items paid, *negative*)
- : employee-brought-product-tools**
Employee Δ brought Π 's product development tools with him.
(NIL, list of tools brought, *negative*)
- : corp2-access-info1-via-disclosure**
 Δ accessed Π 's product information via a common employee or through negotiations.
(NIL, DISCLOSURE-EVENT, *negative*)
- : nondisclosure-agreement-re-corp2-access**
Corporate or Employee Δ had entered into nondisclosure agreement with Π .
(NIL, NONDISCLOSURE-AGREEMENT, *negative*)

Figure 9: Excerpts from Interpretation Frame

4.4.3 CASE POSITIONER

The CASE-POSITIONER builds claim-lattices to position the cfs relative to the "relevant" cases from the CKB. For this purpose, a case is **relevant** or **on point** if the dimensions that apply to it include a dimension that applies to or is a near-miss for the current fact situation. For each applicable or near-miss dimension listed in the case-analysis-record, the POSITIONER retrieves all cases "indexed" by the dimension. A case is **indexed** by a dimension if the top-level CASE frame's dimensions-list slot contains a pointer to that dimension. The POSITIONER searches the *global-catalog*'s typed-list of CASE frames for all such cases.³

The POSITIONER builds two kinds of claim-lattices for any claim for which there are relevant cases:

1. a regular claim-lattice for cases indexed by dimensions that apply to the current fact situation;
2. an extended claim-lattice for cases indexed by dimensions that apply or are near-misses with respect to the current fact situation.

A claim-lattice is a directed acyclic graph each of whose nodes consist of pointers to parent and children nodes, a list of dimensions and a list of cases. Each claim-lattice has a maximal root node whose list of dimensions contains all of the dimensions that apply to the cfs (the D-list) and whose list of cases contains at least the cfs. Each node defines an equivalency class of cases that are equally on point with respect to the current fact situation. In other words, the class contains all cases in the CKB such that the "intersections" of the D-list and the lists of dimensions applicable to each case in the class are the same. In an

³The POSITIONER first sorts the applicable and near-miss dimensions by claim before retrieving the cases.

extended claim-lattice the D-list also contains dimensions that are near misses for the cfs. In either kind of claim-lattice, the dimension list of each node other than the root contains only dimensions that are applicable to the cases in that node.

The ordering scheme of the claim-lattice is the relative "on pointness" of the nodes, that is the relative "inclusiveness" of the dimension lists of each node with respect to the D-list. More particularly, the ordering predicate is "coverage" which compares two lists in terms of which covers a greater portion of a third reference list.⁴

The algorithm for entering a case into the claim-lattice is shown below. The cases can be entered in any order. The algorithm assumes that the case has been placed in a graph-node which will be referred to as "new-node". On the initial call to the algorithm to enter a case, "root" refers to the claim-lattice root containing the cfs.

Algorithm for Inserting Case into Claim-Lattice

1. Compare new-node and root for coverage.
2. If new-node = root, insert case from new-node into root.
3. If new-node < root:

⁴If we consider each list to be a set, the coverage of lists A and B relative to reference list C is as follows:

Equal iff $(A \cap C) = (B \cap C)$

Greater-than iff $(B \cap C) \subset (A \cap C)$

Less-than iff $(A \cap C) \subset (B \cap C)$

Disjoint iff $(A \cap C) \cap (B \cap C) = \emptyset$

Overlapping iff $((A \cap C) \cap (B \cap C) \neq \emptyset) \wedge ((A \cap C) \not\subseteq (B \cap C)) \wedge ((B \cap C) \not\subseteq (A \cap C))$

- (a) For each child of root:
 - i. If $\text{new-node} > \text{child}$, put child into children of new-node. Remove child from children of root.
 - ii. If $\text{new-node} \leq$ or overlaps child, then push child onto new-roots.
 - (b) If $\text{new-node} >$ some child of root, add new-node as child of root.
 - (c) Recursively apply algorithm for each new-root in new-roots.
4. If new-node overlaps root,
- (a) For each child of root:
 - i. If $\text{new-node} > \text{child}$, put child into new-node's children.
 - ii. If $\text{new-node} \leq$ or overlaps child, push child onto new-roots
 - (b) Recursively apply algorithm for each new-root in new-roots.

Figure 10 shows a sample claim-lattice for the *Amezco* fact situation described in Chapter 3. The root node represents the current fact situation and its D-list of dimensions that apply to the cfs. Successor nodes contain pro-plaintiff (Π) or pro-defendant (Δ) cases, involving trade secrets misappropriation claims, that are on point to the cfs. The lists of dimensions in the successor nodes are dimensions that apply to the cases in the node that are shared with the cfs's D-list. Nodes closest to the root contain most-on-point cases. Leaf nodes are least-on-point. Each major branch of the lattice that contains most-on-point cases represents one way of arguing about the current fact situation. Most-on-point cases can be used in the arguments to respond to points citing cases in successor nodes.

4.4.4 BEST-CASE-SELECTOR

The BEST-CASE-SELECTOR selects the most-on-point cases for each side (Π and Δ) on each claim and stores them in the most-on-point cases-by-claim slot of the case-analysis-record. The selection entails performing a depth-first search through the claim-lattice employing the following algorithm.

Algorithm for Selecting Most-on-Point Cases

1. Add the children of the root to a list of new-roots.
2. For each node in new-roots:
 - (a) If the node contains cases citable for a side, add them to the most-on-point cases for that side.
 - (b) Otherwise, if the node contains no cases citable for either side, add the node's children to the beginning of the list of new-roots.

The search descends each branch until it finds a node containing cases citable for a side or until a terminal node is reached. By virtue of the claim-lattice's ordering scheme, the first citable cases encountered in a node are the most on point citable cases on that branch; they have the most dimensions in common with those applicable to the cfs. A node is deemed to contain cases citable for a side if and only if: (1) the node contains cases that held for the side; and (2) the node's dimension list contains at least one dimension that is applicable to the cfs. A similar algorithm is used to select the most-on-point near-miss cases but from the extended claim-lattice. The significance of these near-miss cases is that if the current fact situation were modified so that all of the near-miss dimensions applied these cases would then be most-on-point.

The BEST-CASE-SELECTOR also selects the most-on-point cases that make the most convincing points (i.e., cases "citable in the first instance") and those better reserved for use as counter-examples. The distinction is that even if a case holds for a side, it may not share even one *pro-side* dimension with the cfs. Such a case does not make a convincing point because one cannot draw an analogy between the cases that supports treating them alike. Those cases are still useful as counter-examples if they share *pro-opponent* dimensions with the cfs. They can be used in a response to show that the pro-opponent features are not very important.

The above algorithm represents a first cut at selecting the best cases. Since the lattice is a graph and a single node may have more than one parent, the algorithm may deem a case to be a most-on-point case on one branch even though it is not a most-on-point case on another branch. The existence of any more-on-point proponent cases will turn up when the case is cited in a 3-ply argument, however.

4.4.5 3-PLY-ARGUER

The 3-PLY-ARGUER is responsible for generating arguments about the cfs. The inputs to the ARGUER are the case-analysis-record for the cfs, complete with all of the pro or con most-on-point cases and best cases to cite, claim-lattices, and results of the dimensional-analysis. The outputs are 3-ply arguments and suggestions of hypotheticals that would improve a point or response in the argument.

A 3-ply argument consists of a:

1. Point on behalf of Π or Δ as Side-1 consisting of a:
 - (a) Legal conclusion that Side-1 in a fact situation should win a particular claim.
 - (b) Justification for the legal conclusion in the form of a citation to a prior legal case.
 - (c) Rationale for the justification in the form of an analogy between the fact situation and the cited case.
2. Response on behalf of the opponent as Side-2 consisting of some combination of:
 - (a) Distinguishing the fact situation from the cited case on behalf of Side-2.

(b) Citing counter-examples to the cited-case.

3. **Rebuttal** on behalf of Side-1, again, consisting of a response to any of the counter-examples cited in the Response.

The basic steps of the 3-PLY ARGUER are:

For each claim, for each "case to cite" selected from the best cases to cite or by the user:

1. Generate a filled in "argument-record".
2. Store argument-record in case-analysis-record for cfs.
3. For each argument-record designated by EXPLAINER, generate 3-ply argument and identify useful hypotheticals.

Argument-Records

The primary data structure of the 3-PLY-ARGUER is the argument-record which is a blueprint for generating a 3-ply argument and identifies useful hypotheticals. The first main task of the 3-PLY-ARGUER is to fill out an argument-record for each case to cite about the current fact situation. The 3-PLY ARGUER selects the cases to cite from among the pro or con most-on-point cases listed in the cfs's case-analysis-record or by allowing the attorney to select a case from those in the CKB. Information provided in other argument-records (e.g., counter-examples) or in claim-lattices (e.g., less on point cases lower down in the claim-lattice) guide the attorney as to what cases to select for arguments.

An argument-record's slots, shown in Figure 11, contain three basic kinds of information, for:

1. Drawing an analogy between the cfs and cited case;

2. Distinguishing the cfs from the cited case; and
3. Citing counter-examples to the cited case.

Drawing an analogy between the current fact situation and the cited case means pointing out the features that they share in common that are important for the particular type of claim. The important features are the strengths and weaknesses of the plaintiff's claim in each case as represented by the applicable dimensions. The information for drawing an analogy between the cfs and the cited case is contained in the shared dimensions slot of the argument-record. The slot contains the intersection of the set of dimensions that apply to the current fact situation, taken from the cfs's case-analysis-record, and the set of dimensions applicable to the cited case, taken from the cited case's top level legal-case-frame. When the ARGUER makes a point about the cfs citing this case, it draws the analogy by reciting this information.

Distinguishing the current fact situation from the cited case means pointing out ways in which the cfs is stronger for Side-2 than the cited case from the viewpoint of the claim. Such unshared strengths justify *not* deciding the current fact situation for Side-1 as was done in the cited case. The information for distinguishing is contained in the side-2-distinctions slot. HYPO has two kinds of distinctions based on:

1. Different positions along shared dimensions and
2. Unshared dimensions.

The procedure for collecting distinctions along dimensions is:

For each shared dimension:

1. Compare the cfs and cited case along the dimension using the comparison method appropriate to the type of the dimension;

2. If the difference along the dimension favors Side-2 according to the comparison method and range information for the dimension, the difference is a distinction.

The procedure makes use of generalized comparison methods associated with the dimensions. Each dimension has a comparison type that indicates how to compare cases' strength along a dimension in terms of their relative focal slot values.⁵ Associated with each comparison type is a method that specifies:

1. How to get the focal slot values to compare from the case-frames and interpretation-frames of the two cases. (The "computed" type of dimensional comparison usually involves special means of finding these values or deriving them from other values contained in the case-frames for the cases.)
2. What kind of comparison to make of the values (e.g., set inclusion, \geq , \leq , something v. nothing, position along range, etc.)
3. How to interpret that comparison in light of the direction that would favor the plaintiff (e.g., stronger for plaintiff, weaker or the same.)

The procedure for collecting distinctions based on unshared dimensions is:

1. Get the unshared dimensions (i.e., the set difference of the shared dimensions and the dimensions that apply to only one of the cfs or cited case.)

⁵There are five comparison types:

- Some versus None
- More versus Less
- Relative Position in Ordered Set
- Greater-than versus Less-than
- Computed

2. For each unshared dimension, if it's application only to the cfs (or the cited case) favors Side-2 (or Side-1), it is a distinction. Dimensions are grouped in such a way that given a case's focal slot value, a decision can be made whether the dimension favors a particular side.

Counter-examples are cases that share some or all of the same strengths and weaknesses with the fact situation as the cited case, but where Side-2 won the claim. HYPO has four types of counter-examples:

1. More-on-point;
2. Potentially more-on-point;
3. Overlapping;
4. Boundary.

The argument-record's information for citing counter-examples to the cited case is contained in its slots for mop-counter-exmpl, potent-counter-exmpl, overlap-counter-exmpl and boundary-counter-exmpl.

A **more-on-point** counter-example is a case that held for Side-2 on the claim that has more important strengths and weaknesses in common with the fact situation than the cited case. The counter-example presents a closer analogy to the cited case and therefore is preferable as an authority. The procedure for filling in more-on-point counter-examples is:

For each pro-side-2 most-on-point case listed in the case-analysis record for the cfs:

1. Compare the most-on-point case to the cited case for on-pointness relative to the cfs.
2. If the most-on-point case is more (or as on point) as the cited case, it is a more on point counter-example.

A **potential more-on-point counter-example** is a case that held for Side-2 that would be more on point than the cited case if the fact situation had some extra facts. It is important because it suggests a hypothetical variant of the fact situation in which the potential counter-example would be an actual counter-example more on point than the cited case. In other words, it suggests a possible way of bolstering Side-2's response to the point. A similar procedure is used to collect potential more-on-point counter-examples except that the cited case is compared to the potential most-on-point cases favoring Side-2 listed in the cfs's case-analysis-record. Such a case is a counter-example only if the near-miss dimensions would help side-2 if they applied.

An **overlapping counter-example** is a case that held for Side-2 that has some dimensions in common with the current fact situation. If it is less on point than the cited case, it is not very useful as it is even less analogous to the cfs than the cited case. If however, it overlaps some of the dimensions shared by the cited case and cfs, it has some utility as a counter-example in an argument. The procedure for filling in overlapping counter-examples is the same as for more-on-point counter-examples, except that the test is whether the on-pointness of the two overlap.

A **boundary counter-example** is a case that held for Side-2 even though it is much weaker for Side-2 than the cited case. It shows just how much worse things could be for Side-2 in the fact situation without necessarily causing Side-1 to win. The procedure for finding boundary counter-examples is to find cases that held for Side-2 that are extreme cases along a shared dimension and to compare those extreme cases to the cited case along the dimension. Only dimensions whose ranges are number lines, ordered sets of more than 2 members, or partially ordered sets (as indicated by their comparison types: more versus less, greater-than versus less-than, or relative position in ordered set) index extreme cases.

Generating 3-Ply Arguments from Argument-Records

Each argument-record represents a recipe for making a 3-ply argument about the current fact situation and posing useful hypotheticals. Once an argument-record has been generated, it is relatively straight forward to generate a 3-ply argument. The procedure is:

1. Make a point by citing the argument-record's cited-case on behalf of Side 1 and draw the analogy to cfs by reciting facts associated with the argument-record's shared dimensions;
2. Make a response on behalf of Side 2 by:
 - (a) Reciting Side 2's distinctions from the argument-record;
 - (b) For each more-on-point or boundary counter-example in the argument-record, generate another argument-record with the counter-example as the cited case, make a point for Side 2, and compare this point to original point for Side 1.
3. Make a rebuttal on behalf of Side 1 by responding to any cases cited in the Response.
4. For each potential more on point counter-example in the argument-record, offer to pose hypothetical variant of cfs to show how to bolster response.

HYPO makes four styles of response:

1. Trumping;
2. Partial Counter;
3. Disparaging;
4. Alternative Explanation.

Trumping a point, the most important kind of response, means citing a more-on-point counter-example, that is, citing a case that held for the opponent

and is more on point than the cited case. In light of the Argument Evaluation Criteria, a trumping response is an especially effective way of responding to it. The response says, in effect, that when one takes account of the extra features that the counter-example has in common with the current fact situation, one should reach the opposite legal conclusion from that of the cited case. The response focuses the attorney on the salient differences between the counter-example and the cited case.

The other styles of response are defined as follows: A **Partial Counter** cites a counter-example even if not a trumping one. Even if there are no more-on-point counter-examples, there may still be contrary cases that are as on point or at least overlap the cited case to some extent. A **Disparaging** response attacks the legal significance of the comparison made in the point between the current fact situation and the cited case. It proceeds by showing that even though they may share features, the current fact situation is a much milder example and cites boundary counter-examples to show just how much worse things could be without resulting in a contrary outcome. An **Alternative Explanation** response takes no position as to the legal significance of the comparison in the point, but asserts more simply that the comparison is not fair because there are other features, not shared by the cfs and cited case, that justify the result.

The different response styles are significant for more complex kinds of case-based argument because they focus on different matters of contention and involve differing interpretations of the analogy between the current fact situation and a given precedent cited as a counter-example. In a trumping response, the focus is on the additional shared features of the counter-example. A partial counter focuses on particular shared features. A disparaging response focuses on the relative extremity of shared features. An alternative explanation focuses on features extraneous to the comparison. Thus they illustrate how the context of the argument affects and enriches the meaning of a precedent.

4.4.6 HYPO-GENERATOR

The HYPO-GENERATOR generates hypothetical variations of the current fact situation that are used by the EXPLAINER to demonstrate how points or responses can be strengthened or weakened. The hypotheticals are generated according to specifications provided by the 3-PLY ARGUER. The hypotheticals are "copies" of the current fact situation that are stronger or weaker for a particular side. The modifications are made by adding, changing or removing facts as per the specifications and with the help of five modification heuristics.

The specification for a hypothetical consists of:

- Seed case, the case a copy of which will be modified hypothetically;
- Target case, the case (if any) relative to which the copy of the seed case is to be modified;
- List of changes. Each change consists of a dimension along which to change the copy of the seed case, whether the change is to favor plaintiff or defendant, and whether the target value should be the same as or greater than that in the target or an extreme value along the dimension.

Typically, the seed case is the current fact situation and the target cases are potential counter-examples or potential most-on-point cases as revealed in argument-records or the case-analysis-record of the cfs.

The EXPLAINER determines that a hypothetical should be posed with a seed case, target case and changes favoring a particular side and calls on the 3-PLY ARGUER to fill out the specification. When the hypothetical is posed to bolster a response, for instance, the ARGUER fills out the change list from information contained in the associated argument-record. The ARGUER directs changes along each of the dimensions that the potential counter-example shares, and the cited case does not share, with the cfs's list of applicable and near-miss

dimensions. The direction of the change is to favor Side-2 and the target values are those of the targeted potential counter-example.

Given a specification, the steps for generating a hypothetical are as follows:

1. Make a "copy" of the seed case. The copy is identical to the seed case except that the names of legal-case-frame instances are modified to avoid obliterating the seed case.
2. Implement changes on change list using five heuristics and special modification methods associated with the dimensions.

The heuristics, like "make a near-miss dimension apply", "strengthen or weaken a case along an applicable dimension", or "make an extreme case", use special modification methods similar to the dimensions' comparison methods described above. Like the comparison methods, the modification methods are associated with dimensions' particular comparison types. Instead of simply comparing focal slot values of one case to another case, however, these methods change the values. The modification methods can make a near-miss dimension apply or make an applicable dimension into a near-miss by adding or deleting legal-case-frame facts associated with factual predicates or change the values in a case of a dimension's focal slot.

4.4.7 EXPLAINER

The EXPLAINER has access to all the case-analysis-records generated in a session and in particular to the argument-records for each case-analysis-record. For a given case-analysis-record it explains the strengths and weaknesses of a side's position by:

1. Comparing the strengths of both sides' arguments on a claim and summarizing in a Citation Summary the best cases for each side to cite (i.e., those for which there are no trumping responses.)
2. Displaying 3-ply arguments for the best cases for each side.
3. Suggesting hypothetical "what if's" and "for instances" that illustrate how to bolster particular points and responses or how to make new points.
4. Comparing the strength of a side's position in the current fact situation with that in any of the hypothetical variants that the attorney is interested in examining.

HYPO compares the strength of each side's arguments in a manner consistent with the Argument Evaluation Criteria. The relative strengths of each side's argument is measured by comparing the non-trumped points each can make. If either side has a monopoly on non-trumped points, its position is significantly stronger. If they both can make non-trumped points, then they each have strong positions. The comparative number of non-trumped points is not important. Whether a point is trumped or not is determined from the argument-record. If there is a more-on-point counter-example, it is trumped.

The Citation Summaries are prepared by listing the cases cited in the argument-records for the non-trumped points. In citing cases, where possible HYPO characterizes the cited case with citation labels. Citation labels indicate the degree of support that cases lend to a legal conclusion. The EXPLAINER's citation labels come from The Blue Book [Blue Book, 1986], a standard legal reference work familiar to attorneys. The EXPLAINER has computational definitions of each of the labels in terms of the existence of distinctions and trumping responses and dynamically compiles a list of citations with the information contained in the argument-records.

The EXPLAINER calls the 3-PLY ARGUER to display 3-Ply arguments for all of the non-trumped points for each side. As described above, the attorney may select other cases to cite in 3-ply arguments.

The EXPLAINER determines that there are interesting hypotheticals to suggest by checking for:

1. Potential more-on-point counter-examples in an argument-record. These targets make hypotheticals that show how to bolster a side's response.
2. Distinctions in an argument-record. By posing a hypothetical eliminating the distinctions, a side's point can be bolstered.
3. Potential more-on-point cases in the case-analysis-record. These targets make hypotheticals that show how to make new points.

The SESSION-MANAGER keeps track of the suggested hypotheticals that are interesting and why in the *session-master*'s comparison-list. For each case-analysis-record generated in a session, the comparison-list associates the argument-records and target cases that lead to useful comparisons as well as any hypotheticals actually generated. The comparisons are useful because the target cases, as potential counter-examples or potential most-on-point cases, lead to new responses or points.

The EXPLAINER offers to generate hypothetical variants of the current fact situation for any targets in the comparison list. When the attorney indicates that he wants HYPO to process and compare a hypothetical, the EXPLAINER takes the following steps. It:

1. Calls the HYPO GENERATOR via the 3-PLY ARGUER to generate the actual hypothetical as described above;

2. Updates the SESSION-MANAGER's comparison list to reflect the existence of the new hypothetical and associate it with the argument-record, if any, that occasioned it.
3. Recursively calls the basic processing loop to analyze and generate argument-records for the hypothetical as a new current fact situation with a new case-analysis-record.
4. Compares the arguments for the hypothetical with those of the associated argument-record.

The comparison step involves:

1. Comparing the sides' relative positions in the hypothetical and the seed fact situation to see if any new non-trumped points are gained (or sometimes lost).
2. Comparing the corresponding argument-records for the same cited case in the hypothetical and the seed fact situation to see what new responses are possible.

A replay of the 3-ply arguments for the corresponding argument-records reveals new or changed points and responses introduced by the hypothetical variations and effectively explains the significance of the hypothetical to the attorney's argument. The same kind of comparisons can be done with other cases that have been analyzed during the session.

By guiding the attorney, in the course of a session, to contrast his fact situation to neighboring cases in a space of actual relevant legal cases and of hypothetical variants of the fact situation, the EXPLAINER:

1. Interrogates the attorney about possibly important facts;

2. Allows the attorney to "run" with a line of hypothetical modifications in a "breadth-first" or "depth-first" fashion;
3. Allows the attorney to browse through the cases relevant to his fact situation.

By recursing on hypothetical variations of the original cfs, the EXPLAINER leads the attorney to augment his description of the fact situation. The posed hypotheticals, motivated by potentially significant cases that may affect the balance of the argument, prompt the attorney to identify useful or potentially dangerous facts about which he may not have been aware. The attorney can explore the hypotheticals breadth-first, in effect visiting different branches of a single claim-lattice, or depth-first, by "extending" a particular branch. As new facts are added, new cases become potentially most-on-point opening the way for new responses.

The attorney may also select on subsequent loops a new current fact situation from among the cases cited in argument points and responses. By recursing on cited cases, the attorney can explore the facts and possible arguments of those cases as well as of the original fact situation.

4.4.8 CASE EDITOR

The CASE EDITOR allows the attorney to input a new fact situation or edit an existing one. The EDITOR presents a menu of factual predicates and allows the attorney to input values for them such as T, *negative*, a string indicating the name of an object representable with a legal-case-frame such as a party or a product, or some specific focal slot values. Given a factual predicate and the input value, HYPO's store methods find or instantiate the appropriate legal-case-frames, set the values of the slots, and cross-reference them. The attorney can browse the legal-case-frames in the editor to fill in details.

The EDITOR also allows the attorney to permanently store fact situations in the CKB. The fact situations may be new actual legal cases or interesting hypotheticals generated in the course of a session.

4.5 Reader's Guide

Armed with this overview of HYPO's knowledge sources, reasoning process, architecture, modules, data structures and algorithms, the reader will find additional information as follows:

- **Inputs, Outputs, Examples, Evaluation:** Chapter 5 illustrates HYPO's inputs and outputs and works through its reasoning process, step by step, in a variety of extended examples. HYPO's results in the extended examples are evaluated in Chapter 10. Chapter 9 analyses the outputs to show how HYPO flexibly interprets precedents in light of the argument context and makes determinations about salience.
- **Methodological Detail:** Chapters 6 and 7 provide a more in depth discussion of HYPO's CKB and the Dimensional Index. Chapter 8 provides additional details about the process of selecting the best cases, identifying counter-examples and generating hypotheticals. Additional implementation details may be found in Chapter 11.

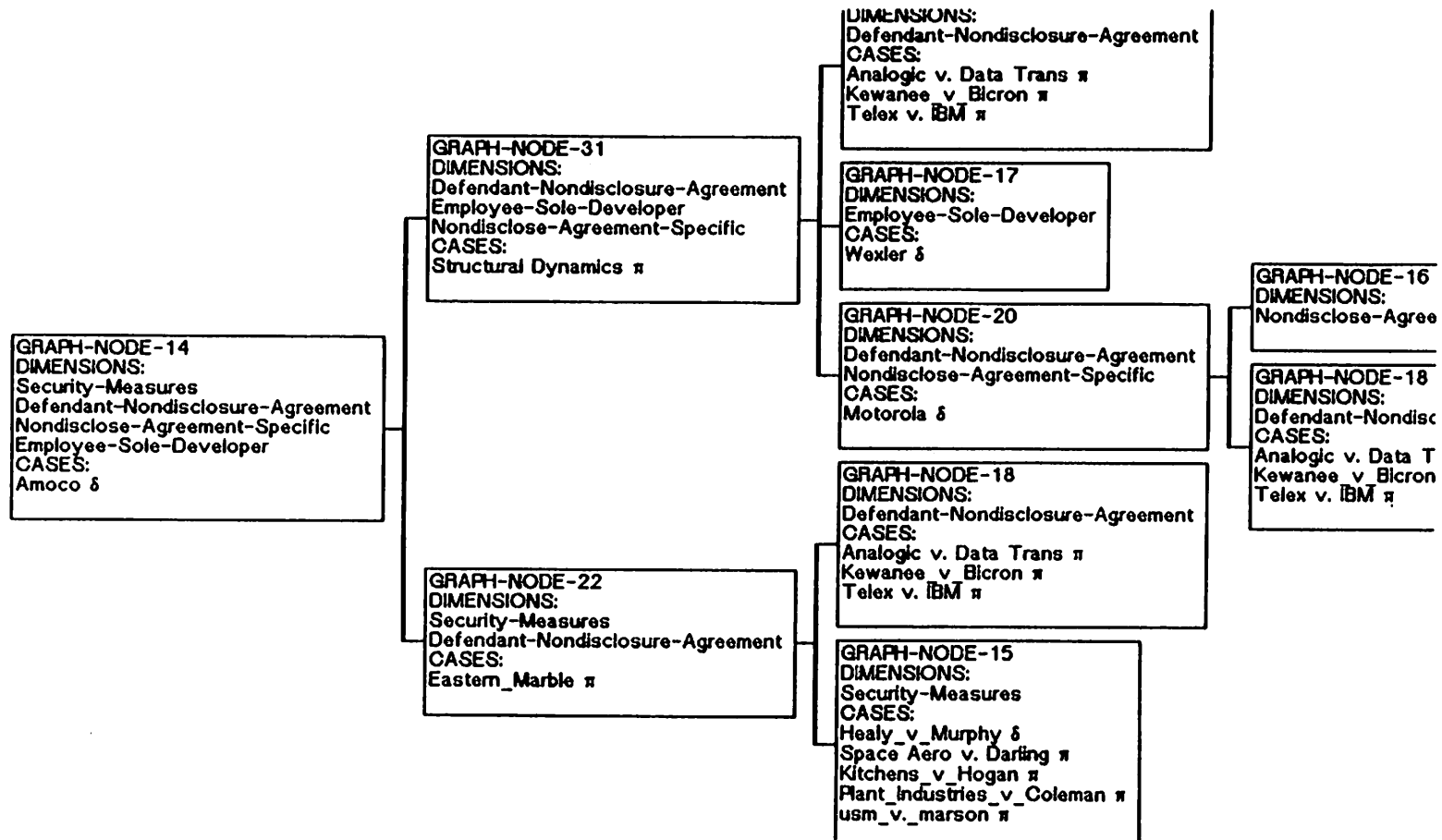

Figure 10: A Sample Claim-Lattice for the Amexco Fact Situation

- : **cfs**
Pointer to the current fact situation.
- : **cited-case**
Pointer to the case cited.
- : **side-1**
Side-1 on behalf of whom a point is made. Can be Π or Δ . Default is side who won cited case.
- : **claim**
Pointer to the type of claim for which the point is made. Default is the type of claim raised in cited case.
- : **shared-dimensions**
List of dimensions shared by cfs and cited case. These are the analogous features of the cfs and cited case.
- : **side-2-distinctions**
List of ways in which cfs is stronger for Side-2, opponent of Side-1, relative to cited case. These are the distinctions between cfs and cited case.
- : **mop-counter-exmpl**
List of more-on-point cases holding for Side-2. These can be cited as more on point counter-examples.
- : **potent-counter-exmpl**
List of potential more-on-point cases holding for Side-2. These are potential counter-examples. Hypotheticals based on these could bolster Side-2's response.
- : **boundary-counter-exmpl**
List of cases worse than cited case for Side-2 on some shared dimension where Side-2 still won. These can be cited as boundary counter-examples to follow up distinctions.
- : **side-1-hypos**
List of targets for hypothetical variants of cfs where Side-1's point would be bolstered.
- : **side-2-hypos**
List of targets for hypothetical variants of cfs where Side-2's response would be bolstered.

Figure 11: Argument-Record

CHAPTER 5

HYPO in Action: Extended Examples

In this chapter, we examine four extended examples of HYPO in action. The goals are to:

1. Familiarize the reader with HYPO's input and output.
2. Demonstrate the steps in HYPO's reasoning process in which it generates arguments and hypotheticals from its analysis of the current fact situation.
3. Illustrate how HYPO's output of arguments and hypotheticals meets the needs of an attorney who is analyzing possible legal claims in a problem situation.

All of the examples in this chapter are based on the fact situations of actual legal cases. It is as if an attorney for one of the parties to the lawsuit were consulting HYPO to help him or her plan arguments to make in court. By using real cases, HYPO's arguments can be compared with those that real lawyers and judges actually made in the cases. As reported in Chapter 10, HYPO's arguments and hypotheticals compare favorably with those actually made in the briefs submitted to the court and in the court's opinions.

The four extended examples comprise the:

1. *Crown Example*, Section 5.1.

2. *Amexco* Example, Section 5.2.
3. *Structural Dynamics* Example, Section 5.3.
4. *USM* Example, Section 5.4.

The *Crown* and *Amexco* Examples are fully discussed in the accompanying commentary in this Chapter. The *USM* Example is discussed in detail in Chapters 6 through Chapters 8. The *Structural Dynamics* example is discussed in some detail in Chapter 8.

5.1 The *Crown* Example

The first example illustrates HYPO's reasoning process in a sequence of runs through the basic processing loop starting with a current fact situation based on the real legal case of *Crown v. Kawneer*, 335 F. Supp. 749 -762 (N.D. Ill., 1971). The facts of the case as reported in the opinion are summarized in a squib in Section 5.1.1. A squib is a structured summary of a legal case much like case briefs prepared by law students¹ Like all of the squibs in this dissertation, this squib was produced manually by an attorney familiar with the opinion of the case. As the squib shows, the court in the *Crown* case held for the defendant where the plaintiff had made disclosures of its alleged trade secret information through negotiations with the defendant and sales to third parties.

Sections 5.1.2 through 5.1.7 correspond roughly to the steps in HYPO's reasoning process as described in Chapter 4:

- Section 5.1.2 shows how the current fact situation is represented in the legal-case-frame language when it is input to the program for analysis. Each of

¹See Chapter 6 for a comparison of squibs and HYPO's legal-case-frames.

the legal-case-frames that are the subjects of the examples in this chapter was prepared manually with the aid of the CASE EDITOR.

- Section 5.1.3 shows the results of HYPO's dimensional analysis of the current fact situation performed by the CASE-ANALYZER, a:
 1. Completed Interpretation Frame; and
 2. Partially completed Case-Analysis-Record.
- Section 5.1.4 shows the claim-lattice and extended claim-lattice generated by HYPO's CASE-POSITIONER to position the current fact situation with respect to relevant cases from the Case Knowledge Base.
- Section 5.1.5 shows the results of the BEST-CASE-SELECTOR which fills in the slots of the case-analysis-record for most on point, most on point near miss and best cases.
- Section 5.1.6 shows the argument records generated by the 3-PLY ARGUER for the best cases.
- Section 5.1.7 show the actual outputs generated by the EXPLAINER with the assistance of the 3-PLY ARGUER and HYPO-GENERATOR including:
 1. Citation Summary;
 2. 3-Ply Arguments;
 3. Suggested Hypotheticals to Consider;
 4. Comparisons of Points.

The following commentary will serve as a guide through the material presented in Sections 5.1.2 through 5.1.7. The sections will be examined in order. The reader who wishes to see HYPO's output for the *Crown* case fact situation should examine Section 5.1.7.

In this example, the *Crown* case appears in two roles, both as:

1. The current fact situation; and
2. A case already in the CKB.

Section 5.1.2 shows the legal-case-frames for representing the *Crown* case as it appears in the CKB. For purposes of this example, we have used that same representation as the current fact situation. In other words, in this example, HYPO re-analyzes a case already in its CKB. In performing the re-analysis, HYPO did not use any of the results of its previous analysis performed when the case was first entered into the CKB. In particular, in making the analysis and generating the arguments and hypotheticals reported in this example, HYPO did not use any of the information contained in the top-level legal-case-frame of the *Crown* case, specifically its listings of who won the case, what claims were involved and the applicable dimensions that index the case in the CKB. HYPO only used the underlying legal-case-frames for representing the facts of the case. The top-level frame is included here in order to show how a case is represented in the CKB and what the actual result of the *Crown* case was.

As shown in Section 5.1.2, the underlying legal-case-frame representation of the facts of the *Crown* case comprises the objects representing the parties, products and alleged trade secret information and disclosure. The CORPORATE-PARTY objects show the roles of the parties in the case (with Crown as plaintiff and Kawneer as defendant) and their relationship as producers of competing products. Crown's PRODUCT "PX-121" is a hydraulic power pack used for automatic door openers. The product development information associated with PX-121 is represented in an instance of KNOWLEDGE called "About-PX-121": it is technical information, was disclosed to 7 persons and none of the disclosures were subject to restriction on further disclosures. The case included information

about a specific DISCLOSURE EVENT where the knowledge was disclosed by plaintiff Crown to defendant Kawneer in contract negotiations.

Section 5.1.3 shows the interpretation frame (INTERP-FRAME) and partially filled out case-analysis-record (ACR) prepared by HYPO's CASE-ANALYZER from the information in the underlying legal-case-frames for the facts of the *Crown* case.

As described in Chapter 4, the interpretation frame shows the values of all of the factual predicates for the current fact situation. The factual predicates correspond to the slots of the INTERP-FRAME. The CASE-ANALYZER fills in the values of the slots automatically.

By reciting the factual predicates and their values in the order presented in the interpretation frame, one can almost generate a narrative summary of the case. In *Crown*, there is a plaintiff ("claimant") corporation, Crown, who makes a product, PX-121 for which there is product development information. A defendant ("respondent") corporation, Kawneer, makes a product, PX-125. The corporations compete with respect to the products. Plaintiff made some disclosures of the information and there are no restrictions with respect to those disclosures. The case includes information about a specific disclosure event and Kawneer gained access to the information through that specific disclosure event.

Having summarized the facts in the form of the interpretation frame, the CASE-ANALYZER knows what factual predicates are satisfied and determines which dimensions' prerequisites, expressed in terms of factual predicates, are satisfied or nearly so. Those results are recorded in the case-analysis-record as shown in Section 5.1.3. Two dimensions apply to the *Crown* case:

1. *Secrets-Voluntarily-Disclosed* (also known as *Secrets-Disclosed-Outsiders*);
2. *Disclosures-In-Negotiations-With-Defendant*

and five dimensions are near misses:

1. *Disclosures-Subject-To-Restriction* (also known as *Outsider-Disclosures-Restricted*)
2. *Competitive-Advantage-Gained*
3. *Vertical-Knowledge*
4. *Security-Measures-Adopted*
5. *Nondisclosure-Agreement-Re-Defendant-Access*

The CASE-POSITIONER takes those applicable and near-miss dimensions, retrieves all of the cases in the CKB indexed by any one of them and constructs claim-lattices as shown in Section 5.1.4 to position the current fact situation relative to the relevant cases. Figure 12 shows the regular claim-lattice. The root node represents the *Crown* case fact situation and its two applicable dimensions. The reference to the "Crown Industries" case under "CASES:" indicates that the CASE-POSITIONER has successfully retrieved the real *Crown* case from the CKB and classified it as most on point to its own fact situation, confirmation that it is correctly assessing on-pointness – a case is most on point to itself.² The claim-lattice also displays six other cases from the CKB that are relevant to analyzing the *Crown* fact situation. Figures 13 and 14 show the overall shape and some detail of the more complex extended claim-lattice.

The BEST-CASE-SELECTOR selects the most-on-point and best cases to cite from the claim-lattice of Figure 12. The most-on-point near-miss cases are taken from the extended claim-lattice of Figures 13 and 14. The most-on-point cases are those closest to the root of each claim-lattice. The best cases are those

²As previously discussed, HYPO analyzed the fact situation of *Crown* as if it were newly introduced to the program and not in the CKB. The various algorithms for selecting the best cases ignore the real *Crown* case to avoid citing the case as authority for a legal point about itself.

closest to the root that are also citable in the first instance for a side. Section 5.1.5 shows the results of the selection.

Section 5.1.6 shows the argument-records (ARG-REC) generated by the 3-PLY ARGUER. Each argument-record deals with a different cited-case. There are five argument-records, one for each best case and one generated for a counter-example. As described in Chapter 4, they were generated using the information in the case-analysis-record and claim-lattices. The counter-examples slots were filled by comparing the cited case to the most-on-point and most-on-point near-miss cases for on-pointness. For example, in ARG-REC-0, the *Data General* case was selected as a potential counter-example (POTENT-COUNTER-EXMPL) because it was one of the most-on-point near-miss cases in the case-analysis-record, was more on point than the cited case, *Midland-Ross* and held for Side-2, the plaintiff. The distinctions slot was filled by comparing the cfs and cited case along shared and unshared dimensions. For example, in ARG-REC-0, the *Crown* fact situation and the *Midland-Ross* case were compared along the dimension they share, SECRETS-VOLUNTARILY-DISCLOSED, where the former was found to be stronger because it involved fewer disclosures. We will examine the argument-records again in connection with the 3-Ply arguments they generate.

The outputs of the EXPLAINER for the *Crown* case are shown in Section 5.1.7. The Citation Summary of Section 5.1.7 shows the attorney two important kinds of information in a given fact situation:

1. Whether the plaintiff or the defendant has a stronger argument position on a particular claim.
2. What are the best cases each side can cite.

As described in Chapter 4, the relative strengths of each side's argument is measured by comparing the non-trumped points each can make. Defendant

Kawneer has the stronger argument because it can make some non-trumped points and plaintiff Crown can make none. The best cases to cite are just those which can be used to make non-trumped points. If both sides could have made some non-trumped points, the EXPLAINER would have determined that both sides can make strong arguments and listed the corresponding best cases to cite for each side.

The EXPLAINER then lists the 3-Ply Arguments for the best cases to cite listed in the Citation Summary. In the *Crown* example, there are four 3-Ply Arguments numbered [1] through [4]. [1] shows the basic components of a typical 3-Ply Argument, a:

1. Point for Side-1 (in this case, the defendant).
2. Response for Side-2 (the plaintiff).
3. Rebuttal for Side-1.

Like all of HYPO's legal points, the Point in [1]:

1. States a legal conclusion that Side-1 should win on a particular claim (here, trade secrets misappropriation);
2. Cites an authority for the conclusion, here the *Midland-Ross* case; and
3. Provides a rationale, consisting of the analogous facts that the cfs and cited case both involved a disclosure of the product development information to outsiders.

As is typical, the Response in [1] consists of a combination of:

1. Distinguishing the cited case, and

2. Citing counter-examples.

Here Side-2's distinction points out that the *Crown* case is stronger for it, the plaintiff, than *Midland-Ross* because there were disclosures to fewer outsiders. Note how the counter-example citing the *Data General* case (a boundary counter-example) follows up on the distinction and drives it home. It says, in effect: "Even if there were many more disclosures to outsiders, as many as in *Data General*, plaintiff should still win." In the absence of *Data General*, another useful boundary counter-example would have been a case that had as many disclosures as the *Crown* case but held for the plaintiff.

In the rebuttal in [1], the 3-PLY ARGUER distinguishes the *counter-example* from Side-1's viewpoint, pointing out that *Data General* should not be followed because the plaintiff's position in the *Crown* case is so much weaker: there were disclosures to outsiders and the disclosees were not restricted from making further disclosures.

The last part of the 3-Ply argument consists of a suggestion of how the response could be strengthened. It poses a hypothetical modification of the current fact situation, which if true, would make the noted case into a trumping counter-example. In [1], the Note points out that if the disclosures to outsiders were restricted, plaintiff could cite the *Data General* case as a trumping counter-example. The "Cf." citation label instructs the attorney to compare the *Data General* case with the current fact situation and the *Midland-Ross* case.

The reader is invited to compare [1] with the information contained in the argument-records from which the 3-PLY ARGUER generated it, specifically with ARG-REC-0 and ARG-REC-1 presented in Section 5.1.6. ARG-REC-0, with *Midland Ross* as cited-case shows the shared dimensions, side-2 distinctions, and various counter-examples: as on point (AS-OP-COUNTER-EXMPL), potential (POTENT-COUNTER-EXMPL), and boundary (BOUNDARY-COUNTER-

EXMPL), from which the analogy, distinctions, counter-examples, and suggested hypothetical were generated. The rebuttal distinctions were generated from ARG-REC-1, which cites *Data General*.

Here are some highlights of the remaining 3-Ply arguments for the *Crown* case:

- Argument [2] is nearly identical to [1] because the cases cited, *Midland-Ross v. Sunbeam* and *Midland-Ross v. Yokana* are nearly identical. One goal for improving HYPO's output is to treat nearly identical cases in the same 3-Ply arguments. Note that in the claim-lattices, these two cases are treated in the same equivalence class.
- Argument [3] shows a comparison with the *Automated Systems* case, which the defendant can use to take advantage of the fact that in *Crown*, the plaintiff disclosed its product information directly to the defendant in negotiations. The distinction points out that in *Automated Systems*, the alleged secret information was of a special type arguably not protected in trade secrets law. See ARG-REC-3 in Section 5.1.6 for the corresponding dimensions. In [3], the response did not cite a counter-example, so there is no rebuttal.
- The *Speedry* case cited in [4] also held for defendant where the plaintiff disclosed the information to the defendant. From the plaintiff's point of view, *Speedry* is not relevantly distinguishable from *Crown* and there are no trumping or as on point counter-examples to cite for Side-2. Nevertheless, the EXPLAINER makes a useful suggestion for the attorney. If one could show that the defendant saved development time and expense or adopted security measures, the current fact situation would be more like *Space Aero* which held for plaintiff even though the plaintiff disclosed its information to defendant in negotiations. In that event, *Space Aero* would be a trumping counter-example citable in response to the *Speedry* case. ARG-REC-4

corresponds to [4]; it lists *Speedry* as a potential counter-example.

Next in the EXPLAINER's outputs are suggested hypothetical modifications that would help either the plaintiff or the defendant on the claim of trade secrets misappropriation. The cases cited are the most-on-point near-miss cases selected by the BEST-CASE-SELECTOR as recorded in the case analysis record. See Section 5.1.5.

There are two things to note about these suggested hypothetical modifications:

1. The EXPLAINER suggests a hypothetical in the most salient context it can. We have seen how the *Data General* and *Space Aero* cases were suggested in the context of the specific arguments where their potential significance would be most apparent, namely as counter-examples to be used to trump specific points. But those cases serve another role, too, as the bases of possible points for the plaintiff given the appropriate additional facts. Their recital in the list of hypotheticals conveys that information.
2. The attorney can select one or more of these suggested hypothetical modifications for further analysis on subsequent runs through the basic processing loop. If a hypothetical is chosen, the EXPLAINER calls on the HYPO-GENERATOR to create a copy of the current fact situation, duly modified, and compares the arguments that can be made for the hypothetical variant with those already made for the original cfs.

The Comparisons part of Section 5.1.7 show the results of the EXPLAINER's hypothesizing. The attorney selected to have HYPO generate a hypothetical variant for the *Crown* fact situation based on the *Data General* case as suggested by the EXPLAINER in the context of Argument [1]. The HYPO-GENERATOR created a variant called "Crown Industries Inc. V. Kawneer Co.-4", which is just

like the *Crown* case except that: (1) all of the disclosures are subject to restriction, as in *Data General*, and (2) all of the object names are changed by adding the version number (i.e., “-4”). The EXPLAINER then replayed the point in [1] (citing the *Midland-Ross* case) in the context of Version 4. Comparing [1] and the new 3-Ply argument [5] [5], it concluded that the plaintiff’s response is strengthened by virtue of the fact that *Data General* could be cited as a trumping counter-example. Note the differences in Side-2’s responses in [1] and [5].

The EXPLAINER’s Citation Summary for Version-4 of the *Crown* case is also shown in Section 5.1.7. As comparison to the original Citation Summary will show, HYPO has revised its assessment of the relative strengths of the parties on a trade secrets claim. Now plaintiff, as well as defendant, can cite untrumped points, a definite improvement in plaintiff’s argument position.

That concludes the discussion of the *Crown* example, the details of which follow.

5.1.1 The Squib for the *Crown* Case

Title: Crown Industries, Inc. v. Kawneer Co.

Cite: 335 F. Supp. 749 -762 (N.D. Ill.)

Date: June 29, 1971

Parties: Π : Crown; Δ : Kawneer

Claim: Trade Secrets Misappropriation

Procedural Setting: Δ moves to dismiss complaint after trial.

Decision: Judgement for Δ dismissing complaint.

Facts:

From 1962 to 1964, Crown developed a hydraulic power pack, PX-121, for automatic door openers. Crown complained that Kawneer Co. developed a competing product, PX-125, by misappropriating π 's trade secrets. Crown's power packs had been sold to and installed in five public retail establishments where the units were accessible for inspection. Crown made disclosures about the power pack to another third party, and in 1963 and 1965 a Crown employee made disclosures concerning the pack to Kawneer in connection with possible contract negotiations. None of the disclosees entered into any agreement with Crown to keep the information confidential or not to use the information. PX-121 did not have any unique features not generally known to the prior art. It took Kawneer six years to develop PX-125, from 1962 to 1968. Kawneer developed the PX-125 independently of Crown's disclosed information.

Issues: (1) Did Π lose its trade secrets in the PX-121 by making public disclosures through its sale of the units and disclosures to a third party and to defendant?

(2) Did Δ breach a confidential relationship with Π regarding the disclosed information?

Holding: (1) Held for Δ : Yes.

(2) Held for Δ : No. Δ did not enter into a nondisclosure agreement with Π .

Cases cited: re (2): *Midland-Ross Corp. v. Sunbeam Equipment Co.*, 316 F. Supp. 171 (W.D.Pa 1970), affirmed, 435 F.2d 159 (3d Cir. 1970).

5.1.2 Case Representation of *Crown*

The Top-level Legal-Case-Frame:

<CASE : Crown Industries Inc. v. Kawneer Co.>

NAME: Crown Industries Inc. v. Kawneer Co.

SHORT-TITLE: "Crown Industries"

CITATION: "335 F. Supp. 749 (N.D. Ill., 1971)"

DATE: (1971)

PARTY-LIST:

(<CORPORATE-PARTY : CROWN> <CORPORATE-PARTY : KAWNEER>)

ROLE-PARTY-ALIST:

((PLAINTIFF <CORPORATE-PARTY : CROWN>)

(DEFENDANT <CORPORATE-PARTY : KAWNEER>))

DECISION-FOR: (<CORPORATE-PARTY : KAWNEER>)

CLAIMS-HELD-FOR:

((<TYPE-OF-CLAIM : TRADE-SECRETS-MISAPPROPRIATION>

<CORPORATE-PARTY : KAWNEER>))

DIMENSIONS-LIST:

(<DIMENSION : SECRETS-VOLUNTARILY-DISCLOSED>

<DIMENSION : DISCLOSURE-IN-NEGOTIATIONS-WITH-DEFENDANT>)

CLAIM-DIMENSIONS-ALIST:

((<TYPE-OF-CLAIM : TRADE-SECRETS-MISAPPROPRIATION>

<DIMENSION : SECRETS-VOLUNTARILY-DISCLOSED>))

CASES-CITED: "Midland-Ross Corp. v. Sunbeam Equipment Co."

The Parties:

<CORPORATE-PARTY : CROWN>

NAME: CROWN

CASE-ROLE: (PLAINTIFF)

CASE: <CASE : Crown Industries Inc. v. Kawneer Co.>

EMPLOYEE-LIST: NIL

COMPETITOR-PRODUCT-ALIST:

((<CORPORATE-PARTY : KAWNEER> <PRODUCT : PX-125>))

PRODUCT-LIST: (<PRODUCT : PX-121>)

<CORPORATE-PARTY : KAWNEER>

NAME: KAWNEER

CASE-ROLE: (DEFENDANT)

CASE: <CASE : Crown Industries Inc. v. Kawneer Co.>

EMPLOYEE-LIST: NIL

COMPETITOR-PRODUCT-ALIST:

((<CORPORATE-PARTY : CROWN> <PRODUCT : PX-121>))

PRODUCT-LIST: (<PRODUCT : PX-125>)

The Products:

<PRODUCT : PX-121>

NAME: PX-121

CASE: <CASE : Crown Industries Inc. v. Kawneer Co.>

A-KIND-OF: (HYDRAULIC-POWER-PACK)

PRODUCT-USED-FOR: (AUTOMATIC-DOOR-OPENERS)

GENERAL-PRODUCT-MARKET: (BUILDING-OWNERS)

TECHNOLOGY-USED: NIL

COMPARISON-W-GENERALLY-AVAILABLE-COMPETITIVE-PRODUCTS: NIL

COMPETITORS-PRODUCT-ALIST:

((<CORPORATE-PARTY : KAWNEER> <PRODUCT : PX-125>))

DEVELOPER: (<CORPORATE-PARTY : CROWN>)

CUSTOMER-LIST: NIL

EMPLOYMENT-WORKED-ON-PROJECT-LIST: NIL

PROJECT-DEVELOPMENT-START: NIL

PROJECT-DEVELOPMENT-END: NIL

PROJECT-DEVELOPMENT-TIME: NIL

EXPENDITURES-MADE: NIL

KNOWLEDGE-USED: (<KNOWLEDGE : ABOUT-PX-121>)

SECURITY-MEASURES-LIST: NIL

SECURITY-BREACH-LIST: NIL

EX-INTRINSIC-SIMILARITIES-WITH-COMPETITIVE-PRODUCT: NIL

<PRODUCT : PX-125>

NAME: PX-125

CASE: <CASE : Crown Industries Inc. v. Kawneer Co.>

A-KIND-OF: (HYDRAULIC-POWER-PACK)

PRODUCT-USED-FOR: (AUTOMATIC-DOOR-OPENERS)

GENERAL-PRODUCT-MARKET: (BUILDING-OWNERS)

TECHNOLOGY-USED: NIL

COMPARISON-W-GENERALLY-AVAILABLE-COMPETITIVE-PRODUCTS: NIL

COMPETITORS-PRODUCT-ALIST:

((<CORPORATE-PARTY : CROWN> <PRODUCT : PX-121>))

DEVELOPER: (<CORPORATE-PARTY : KAWNEER>)

CUSTOMER-LIST: NIL

EMPLOYMENT-WORKED-ON-PROJECT-LIST: NIL

PROJECT-DEVELOPMENT-START: NIL
PROJECT-DEVELOPMENT-END: NIL
PROJECT-DEVELOPMENT-TIME: NIL
EXPENDITURES-MADE: NIL
KNOWLEDGE-USED: (<KNOWLEDGE : ABOUT-PX-121>)
SECURITY-MEASURES-LIST: NIL
SECURITY-BREACH-LIST: NIL
EX-INTRINSIC-SIMILARITIES-WITH-COMPETITIVE-PRODUCT:
(BETWEEN-PX-121-AND-PX-125)

Alleged Trade Secret Information and Disclosure:

<KNOWLEDGE : ABOUT-PX-121>

NAME: ABOUT-PX-121

CASE: <CASE : Crown Industries Inc. v. Kawneer Co.>

KNOWLEDGE-ABOUT: (<PRODUCT : PX-121>)

KIND-OF-KNOWLEDGE: (TECHNICAL)

PARTY-WITH-ACCESS-LIST:

(<CORPORATE-PARTY : CROWN> <CORPORATE-PARTY : KAWNEER>)

SPECIFIC-DISCLOSURE-EVENTS:

(<DISCLOSURE-EVENT : CROWN-DISCLOSES-TO-KAWNEER>)

NUMBER-DISCLOSEES: (7)

PERCENT-DISCLOSEES-RESTRICTED: (0.0)

DISCLOSURE-RESTRICTION: NIL

GENERALLY-KNOWN-IN-INDUSTRY: NIL

<DISCLOSURE-EVENT : CROWN-DISCLOSES-TO-KAWNEER>

NAME: CROWN-DISCLOSES-TO-KAWNEER

CASE: <CASE : —Crown Industries Inc. v. Kawneer Co.—>

INFO-DISCLOSED: (<KNOWLEDGE : ABOUT-PX-121>)

DISCLOSER: (<CORPORATE-PARTY : CROWN>)

DISCLOSEE: (<CORPORATE-PARTY : KAWNEER>)

HOW-DISCLOSURES-MADE: (NEGOTIATION)

TIME-TO-GENERATE-INFO-FROM-DISCLOSURE: NIL

NONDISCLOSURE-AGREEMENTS: NIL

5.1.3 Dimensional Analysis of *Crown*

The Interpretation Frame After Dimensional Analysis:

<INTERP-FRAME : CROWN INDUSTRIES INC. V. KAWNEER CO. : INTERP-FRAME>

CASE: <CASE : Crown Industries Inc. v. Kawneer Co.>
 EXISTS-CLAIMANT-CORP1: <CORPORATE-PARTY : CROWN>
 CLAIMANT-MAKES-PRODUCT1: <PRODUCT : PX-121>
 EXISTS-CLAIMANTS-INFO-RE-PRODUCT1:
 <KNOWLEDGE : ABOUT-PX-121>
 EXISTS-RESPONDENT-CORP2: <CORPORATE-PARTY : KAWNEER>
 RESPONDENT-MAKES-PRODUCT2: <PRODUCT : PX-125>
 CORPS-1-2-COMPETE: T
 CORPS-1-2-COMPETE-RE-PRODUCTS-1-2: T
 EXISTS-RESPONDENT-EMPLOYEE1: NIL
 EMPLOYEE1-WORKED-FOR-CLAIMANT: NIL
 EMPLOYEE1-WORKED-FOR-RESPONDENT: NIL
 EXISTS-COMMON-EMPLOYEE1: NIL
 EXISTS-EMPLOYMENT-CHANGE: NIL
 EMPLOYEE-PAID-TO-SWITCH: NIL
 EMPLOYEE-BROUGHT-PRODUCT-TOOLS: NIL
 EMPLOYEE-WORKED-ON-PRODUCT1: NIL
 CORP2-ACCESS-PRODUCT1-VIA-EMPLOYEE1: NIL
 CORP1-EMPLOYEE1-AGREEMENT: NIL
 EXISTS-PERSON-ASSERTING-CONTRACT: NIL
 EXISTS-PERSON-DENYING-CONTRACT: NIL
 EXISTS-PURPORTED-AGREEMENT: NIL
 EXISTS-DISCLOSURES-INFO1: *AFFIRMATIVE*
 KNOW-WHAT-KIND-INFO1: NIL
 CORP2-SAVED-EXPENSE: *NEGATIVE*
 EXISTS-RESTRICTIONS-DISCLOSURES-INFO1: *NEGATIVE*
 EXISTS-INFO-RE-SECURITY-MEASURES: NIL
 INFO1-DISCLOSED-CORPS-1-2-NEGOTIATIONS:
 <DISCLOSURE-EVENT : CROWN-DISCLOSES-TO-KAWNEER>
 CORP2-ACCESS-INFO1-VIA-DISCLOSURE:
 (<DISCLOSURE-EVENT : CROWN-DISCLOSES-TO-KAWNEER>)
 NONDISCLOSURE-AGREEMENT-RE-CORP2-ACCESS: NIL

EXISTS-DATA-RE-SPECIFICITY: NIL
EXISTS-DATA-RE-SOLE-DEVELOPER: NIL

The Case-Analysis-Record after Dimensional Analysis:

<ACR : CROWN INDUSTRIES INC. V. KAWNEER CO. : ACR>

CASE: <CASE : Crown Industries Inc. v. Kawneer Co.>

INTERP-FRAME:

<INTERP-FRAME : CROWN INDUSTRIES INC. V. KAWNEER CO. : INTERP-FRAME>

APPLICABLE-DIMENSIONS:

(<DIMENSION : SECRETS-VOLUNTARILY-DISCLOSED>
<DIMENSION : DISCLOSURE-IN-NEGOTIATIONS-WITH-DEFENDANT>)

NEAR-MISS-DIMENSIONS:

(<DIMENSION : DISCLOSURES-SUBJECT-TO-RESTRICTION>
<DIMENSION : COMPETITIVE-ADVANTAGE-GAINED>
<DIMENSION : VERTICAL-KNOWLEDGE>
<DIMENSION : SECURITY-MEASURES-ADOPTED>
<DIMENSION : NONDISCLOSURE-AGREEMENT-RE-DEFENDANT-ACCESS>)

CLAIM-LATTICES:

((<TYPE-OF-CLAIM : TRADE-SECRETS-MISAPPROPRIATION>
<GRAPH-NODE-0>))

EXTENDED-CLAIM-LATTICES:

((<TYPE-OF-CLAIM : TRADE-SECRETS-MISAPPROPRIATION>
<GRAPH-NODE-14>))

5.1.4 Positioning *Crown*

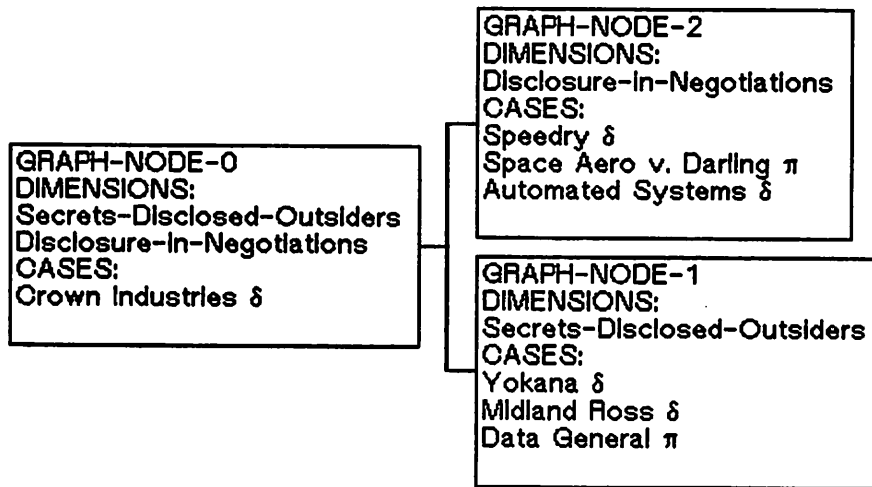
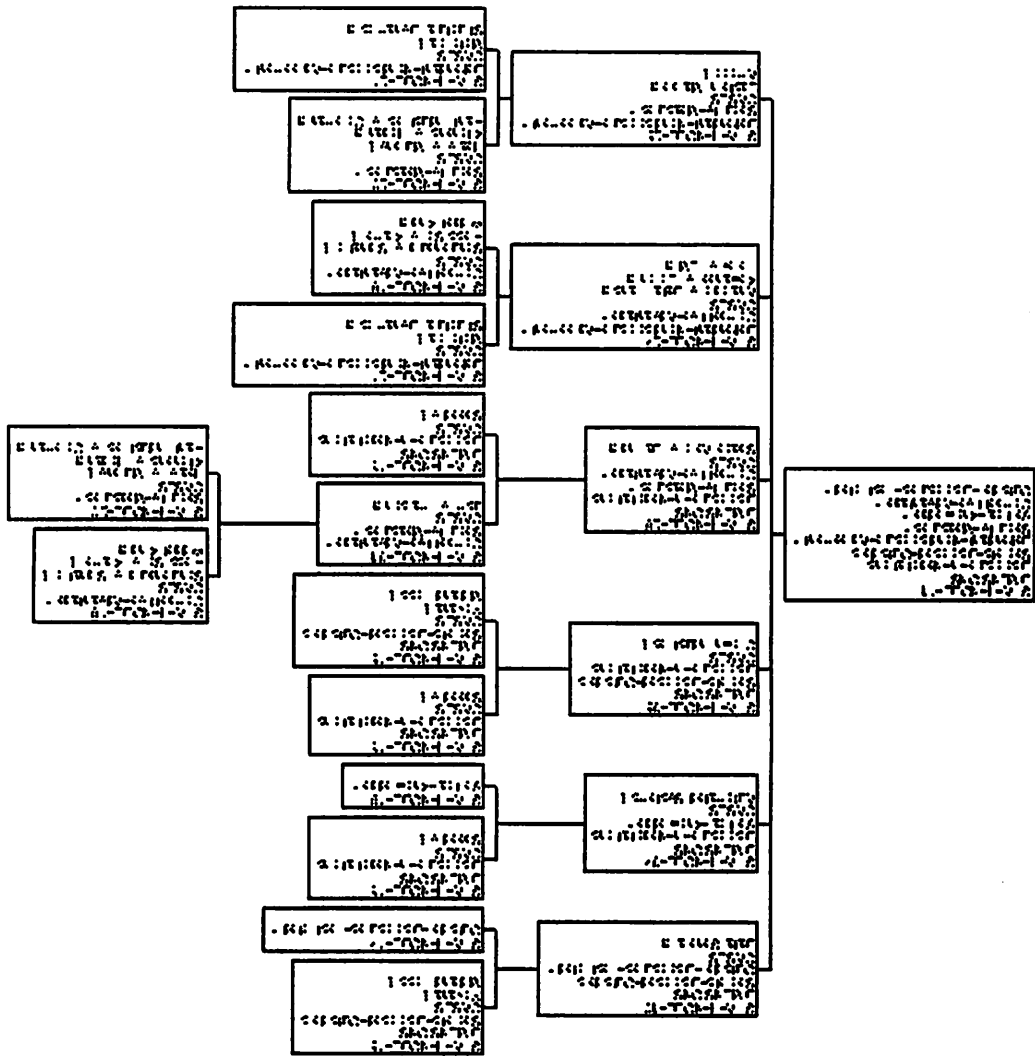

Figure 12: Claim-Lattice for the *Crown* Example.

Figure 13: Overall Shape of Extended Claim-Lattice for the Crown Example.



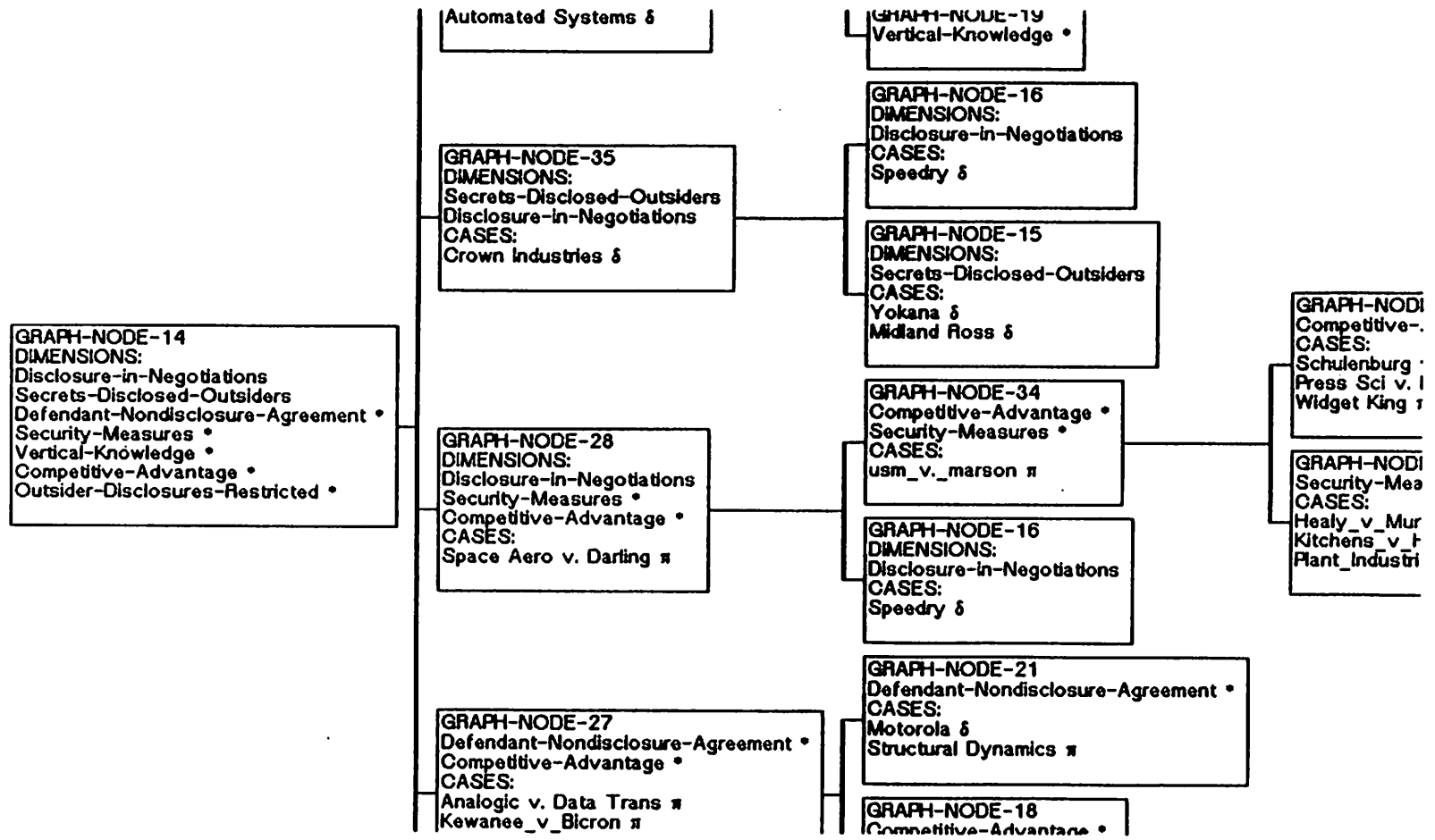

Figure 14: Detail of Extended Claim-Lattice for the *Crown* Example.

5.1.5 Best Case Selection in *Crown*

The Case-Analysis-Record After Best Case Selection:

<ACR : CROWN INDUSTRIES INC. V. KAWNEER CO. : ACR>

CASE: <CASE : Crown Industries Inc. v. Kawneer Co.>

CLAIM-LATTICES:

((<TYPE-OF-CLAIM : TRADE-SECRETS-MISAPPROPRIATION>
<GRAPH-NODE-0>))

EXTENDED-CLAIM-LATTICES:

((<TYPE-OF-CLAIM : TRADE-SECRETS-MISAPPROPRIATION>
<GRAPH-NODE-14>))

MOST-ON-POINT-CASES-BY-CLAIM:

((<TYPE-OF-CLAIM : TRADE-SECRETS-MISAPPROPRIATION>
(PLAINTIFF
<CASE : Data General Corp. v. Digital Computer Controls Inc.>
<CASE : Space Aero Products Co. v. R.E. Darling Co.>
(DEFENDANT
<CASE : Midland-Ross Corp. v. Sunbeam Equipment Corp.>
<CASE : midland-ross corp. v. yokana>
<CASE : Automated-Systems v. Service-Bureau>
<CASE : Speedry Chemical Products, Inc. v. Carter's Ink Company>)))

MOST-ON-POINT-NEAR-MISS-CASES-BY-CLAIM:

(<TYPE-OF-CLAIM : TRADE-SECRETS-MISAPPROPRIATION>
(PLAINTIFF
<CASE : Eastern Marble Products Corp. v. Roman Marble, Inc.>
<CASE : telex corp. v. ibm corp. (1)>
<CASE : Kewanee Oil Co. v. Bicron Corp.>
<CASE : Analogic Corp. v. Data Translation, Inc.>
<CASE : Space Aero Products Co. v. R.E. Darling Co.>
<CASE : Data General Corp. v. Digital Computer Controls Inc.>
(DEFENDANT
<CASE : Automated-Systems v. Service-Bureau>)))

BEST-CASES-BY-CLAIM:

((<TYPE-OF-CLAIM : TRADE-SECRETS-MISAPPROPRIATION>

(PLAINTIFF)

(DEFENDANT

<CASE : Midland-Ross Corp. v. Sunbeam Equipment Corp.>

<CASE : midland-ross corp. v. yokana>

<CASE : Automated-Systems v. Service-Bureau>

<CASE : Speedry Chemical Products, Inc. v. Carter's Ink Company>)))

5.1.6 Argument Records for Crown

<ARG-REC-0>

NAME: ARG-REC-0

CFS: <CASE : Crown Industries Inc. v. Kawneer Co.>

CFS-ACR: <ACR : CROWN INDUSTRIES INC. V. KAWNEER CO. : ACR>

SIDE-1: DEFENDANT

CLAIM: <TYPE-OF-CLAIM : TRADE-SECRETS-MISAPPROPRIATION>

CITED-CASE-ACR: <ACR : MIDLAND-ROSS CORP. V. SUNBEAM EQUIPMENT CORP. : ACR>

CITED-CASE: <CASE : Midland-Ross Corp. v. Sunbeam Equipment Corp.>

SHARED-DIMENSIONS:

(<DIMENSION : SECRETS-VOLUNTARILY-DISCLOSED>)

SIDE-2-DISTINCTIONS:

((:STRONGER

<CASE : Crown Industries Inc. v. Kawneer Co.>

<CASE : Midland-Ross Corp. v. Sunbeam Equipment Corp.>

<DIMENSION : SECRETS-VOLUNTARILY-DISCLOSED> LESS 7 97))

MOP-COUNTER-EXMPL: NIL

AS-OP-COUNTER-EXMPL:

(<CASE : Data General Corp. v. Digital Computer Controls Inc.>)

POTENT-COUNTER-EXMPL:

(<CASE : Data General Corp. v. Digital Computer Controls Inc.>)

OVERLAP-COUNTER-EXMPL: NIL

BOUNDARY-COUNTER-EXMPL:

((<CASE : Data General Corp. v. Digital Computer Controls Inc.>

<DIMENSION : SECRETS-VOLUNTARILY-DISCLOSED>))

LESS-ON-POINT-CON-CASES: NIL

SIDE-1-HYPOS: NIL

SIDE-2-HYPOS:

(<CASE : Data General Corp. v. Digital Computer Controls Inc.>)

RESPONSIVE-ARG-RECS: (<ARG-REC-1>)

<ARG-REC-1>

NAME: ARG-REC-1

CFS: <CASE : Crown Industries Inc. v. Kawneer Co.>

CFS-ACR: <ACR : CROWN INDUSTRIES INC. V. KAWNEER CO. : ACR>

SIDE-1: PLAINTIFF

CLAIM: <TYPE-OF-CLAIM : TRADE-SECRETS-MISAPPROPRIATION>

CITED-CASE-ACR:

<ACR : DATA GENERAL CORP. V. DIGITAL COMPUTER CONTROLS
INC. : ACR>

CITED-CASE:

<CASE : Data General Corp. v. Digital Computer Controls Inc.>

SHARED-DIMENSIONS:

(<DIMENSION : SECRETS-VOLUNTARILY-DISCLOSED>)

SIDE-2-DISTINCTIONS:

((:STRONG

<CASE : Crown Industries Inc. v. Kawneer Co.>

<DIMENSION : DISCLOSURE-IN-NEGOTIATIONS-WITH-DEFENDANT>)

(:STRONG

<CASE : Data General Corp. v. Digital Computer Controls Inc.>

<DIMENSION : DISCLOSURES-SUBJECT-TO-RESTRICTION>))

MOP-COUNTER-EXMPL: NIL

AS-OP-COUNTER-EXMPL:

(<CASE : midland-ross corp. v. yokana>

<CASE : Midland-Ross Corp. v. Sunbeam Equipment Corp.>)

POTENT-COUNTER-EXMPL: NIL

OVERLAP-COUNTER-EXMPL: NIL

BOUNDARY-COUNTER-EXMPL: NIL

LESS-ON-POINT-CON-CASES: NIL

SIDE-1-HYPOS: NIL

SIDE-2-HYPOS: NIL

RESPONSIVE-ARG-RECS: NIL

<ARG-REC-2>

NAME: ARG-REC-2

CFS: <CASE : Crown Industries Inc. v. Kawneer Co.>

CFS-ACR: <ACR : CROWN INDUSTRIES INC. V. KAWNEER CO. : ACR>

SIDE-1: DEFENDANT

CLAIM: <TYPE-OF-CLAIM : TRADE-SECRETS-MISAPPROPRIATION>

CITED-CASE-ACR: <ACR : MIDLAND-ROSS CORP. V. YOKANA : ACR>

CITED-CASE: <CASE : midland-ross corp. v. yokana>

SHARED-DIMENSIONS:

(<DIMENSION : SECRETS-VOLUNTARILY-DISCLOSED>)

SIDE-2-DISTINCTIONS:

((:STRONGER

<CASE : Crown Industries Inc. v. Kawneer Co.>

<CASE : midland-ross corp. v. yokana>

<DIMENSION : SECRETS-VOLUNTARILY-DISCLOSED> LESS 7 100))

MOP-COUNTER-EXMPL: NIL

AS-OP-COUNTER-EXMPL:

(<CASE : Data General Corp. v. Digital Computer Controls Inc.>)

POTENT-COUNTER-EXMPL:

(<CASE : Data General Corp. v. Digital Computer Controls Inc.>)

OVERLAP-COUNTER-EXMPL: NIL

BOUNDARY-COUNTER-EXMPL:

((<CASE : Data General Corp. v. Digital Computer Controls Inc.>

<DIMENSION : SECRETS-VOLUNTARILY-DISCLOSED>))

LESS-ON-POINT-CON-CASES: NIL

SIDE-1-HYPOS: NIL

SIDE-2-HYPOS:

(<CASE : Data General Corp. v. Digital Computer Controls Inc.>)

RESPONSIVE-ARG-RECS: (<ARG-REC-1>)

<ARG-REC-3>

NAME: ARG-REC-3

CFS: <CASE : Crown Industries Inc. v. Kawneer Co.>

CFS-ACR: <ACR : CROWN INDUSTRIES INC. V. KAWNEER CO. : ACR>

SIDE-1: DEFENDANT

CLAIM: <TYPE-OF-CLAIM : TRADE-SECRETS-MISAPPROPRIATION>

CITED-CASE-ACR: <ACR : AUTOMATED-SYSTEMS V. SERVICE-BUREAU
: ACR>

CITED-CASE: <CASE : Automated-Systems v. Service-Bureau>

SHARED-DIMENSIONS:

(<DIMENSION : DISCLOSURE-IN-NEGOTIATIONS-WITH-DEFENDANT>)

SIDE-2-DISTINCTIONS:

((:STRONG

<CASE : Automated-Systems v. Service-Bureau>

<DIMENSION : VERTICAL-KNOWLEDGE>))

MOP-COUNTER-EXMPL: NIL

AS-OP-COUNTER-EXMPL: NIL

POTENT-COUNTER-EXMPL: NIL

OVERLAP-COUNTER-EXMPL: NIL

BOUNDARY-COUNTER-EXMPL: NIL

LESS-ON-POINT-CON-CASES: NIL

SIDE-1-HYPOS: NIL

SIDE-2-HYPOS: NIL

RESPONSIVE-ARG-RECS: NIL

<ARG-REC-4>

NAME: ARG-REC-4

CFS: <CASE : Crown Industries Inc. v. Kawneer Co.>

CFS-ACR: <ACR : CROWN INDUSTRIES INC. V. KAWNEER CO. : ACR>

SIDE-1: DEFENDANT

CLAIM: <TYPE-OF-CLAIM : TRADE-SECRETS-MISAPPROPRIATION>

CITED-CASE-ACR:

<ACR : SPEEDRY CHEMICAL PRODUCTS, INC. V. CARTER'S INK COMPANY : ACR>

CITED-CASE:

<CASE : Speedry Chemical Products, Inc. v. Carter's Ink Company>

SHARED-DIMENSIONS:

(<DIMENSION : DISCLOSURE-IN-NEGOTIATIONS-WITH-DEFENDANT>)

SIDE-2-DISTINCTIONS: NIL

MOP-COUNTER-EXMPL: NIL

AS-OP-COUNTER-EXMPL: NIL

POTENT-COUNTER-EXMPL:

(<CASE : Space Aero Products Co. v. R.E. Darling Co.>)

OVERLAP-COUNTER-EXMPL: NIL

BOUNDARY-COUNTER-EXMPL: NIL

LESS-ON-POINT-CON-CASES: NIL

SIDE-1-HYPOS: NIL

SIDE-2-HYPOS:

(<CASE : Space Aero Products Co. v. R.E. Darling Co.>)

RESPONSIVE-ARG-RECS: NIL

5.1.7 Argument Outputs for *Crown*

Citation Summary:

3-Ply Arguments for Best Cases to Cite
on Claim of TRADE-SECRETS-MISAPPROPRIATION
in Fact Situation of Crown Industries:

On a claim for TRADE-SECRETS-MISAPPROPRIATION,
DEFENDANT can make a stronger argument.
DEFENDANT can cite the following cases
for which there are
no more on point counter-examples:

Speedry Chemical Products, Inc. V. Carter's Ink Company
306 F.2d 328 (2d Cir., 1962)

Automated-Systems V. Service-Bureau
401 F.2d 619 (10 Cir., 1968)

Midland-Ross Corp. V. Yokana
293 F. 2d 411 (3 Cir. 1961)

Midland-Ross Corp. V. Sunbeam Equipment Corp.
316 F. Supp 171 (W.D. Pa., 1970)

3-Ply Arguments in *Crown*:

[1]

==> POINT for DEFENDANT as Side-1:

WHERE:

Plaintiff disclosed its product information to outsiders.

DEFENDANT should win a claim for TRADE-SECRETS-MISAPPROPRIATION.

CITE: *Midland-Ross Corp. V. Sunbeam Equipment Corp.*
316 F. Supp 171 (W.D. Pa., 1970).

<== RESPONSE for PLAINTIFF as Side-2:

Midland-Ross Corp. V. Sunbeam Equipment Corp. is distinguishable because:
In *Midland Ross*, plaintiff disclosed its product information to
more outsiders than in *Crown Industries***COUNTER-EXAMPLES:***Data General Corp. V. Digital Computer Controls Inc.*
357 A.2d 105 (Del. Ch. 1975), held for PLAINTIFF even though in
Data General plaintiff disclosed its
product information to more outsiders than in *Midland-Ross Corp. V. Sunbeam*
Equipment Corp.

==> REBUTTAL for DEFENDANT as Side-1:

Data General Corp. V. Digital Computer Controls Inc. is distinguishable because:
In *Crown Industries*, Plaintiff disclosed its product information in negotiations
with defendant. Not so in *Data General*.
In *Data General*, plaintiff's disclosures to outsiders were restricted. Not so in
Crown Industries.**NOTE:**PLAINTIFF's response would be strengthened if:
Plaintiff's disclosures to outsiders were restricted.
Cf. *Data General Corp. V. Digital Computer Controls Inc.*
357 A.2d 105 (Del. Ch. 1975)

[2]

==> POINT for DEFENDANT as Side-1:

WHERE:

Plaintiff disclosed its product information to outsiders.

DEFENDANT should win a claim for TRADE-SECRETS-MISAPPROPRIATION.

CITE: Midland-Ross Corp. V. Yokana
293 F. 2d 411 (3 Cir. 1961).

<== RESPONSE for PLAINTIFF as Side-2:

Midland-Ross Corp. V. Yokana is distinguishable because:

In Yokana, plaintiff disclosed its product information to more outsiders than in Crown Industries

COUNTER-EXAMPLES:

Data General Corp. V. Digital Computer Controls Inc.
357 A.2d 105 (Del. Ch. 1975), held for PLAINTIFF
even though in Data General plaintiff disclosed its product information to more outsiders than in Midland-Ross Corp. V. Yokana.

==> REBUTTAL for DEFENDANT as Side-1:

Data General Corp. V. Digital Computer Controls Inc. is distinguishable because:

In Crown Industries, Plaintiff disclosed its product information in negotiations with defendant. Not so in Data General.

In Data General, plaintiff's disclosures to outsiders were restricted. Not so in Crown Industries.

NOTE:

PLAINTIFF's response would be strengthened if:

Plaintiff's disclosures to outsiders were restricted.

Cf. Data General Corp. V. Digital Computer Controls Inc.
357 A.2d 105 (Del. Ch. 1975)

[3]

==> POINT for DEFENDANT as Side-1:

WHERE:

Plaintiff disclosed its product information in negotiations with defendant.

DEFENDANT should win a claim for TRADE-SECRETS-MISAPPROPRIATION.

CITE: Automated-Systems V. Service-Bureau
401 F.2d 619 (10 Cir., 1968).

<== RESPONSE for PLAINTIFF as Side-2:

Automated-Systems V. Service-Bureau is distinguishable because:

In Automated Systems, plaintiff's product information was about customer business relations. Not so in Crown Industries.

==> REBUTTAL for DEFENDANT as Side-1:

None.

[4]

==> POINT for DEFENDANT as Side-1:

WHERE:

Plaintiff disclosed its product information in negotiations with defendant.

DEFENDANT should win a claim for TRADE-SECRETS-MISAPPROPRIATION.

CITE: Speedry Chemical Products, Inc. V. Carter's Ink Company
306 F.2d 328 (2d Cir., 1962).

<== RESPONSE for PLAINTIFF as Side-2:

None.

==> REBUTTAL for DEFENDANT as Side-1:

None.

NOTE:

PLAINTIFF's response would be strengthened if:
Defendant's access to plaintiff's product information saved it time or expense.
Plaintiff adopted security measures.
Cf. Space Aero Products Co. V. R.E. Darling Co.
208 A.2d 74 (Ct.App., Md., 1965)

Suggested Hypotheticals in *Crown*:

**Hypotheticals to Consider
on Claim of TRADE-SECRETS-MISAPPROPRIATION
in Fact Situation of Crown Industries:**

PLAINTIFF's position would be strengthened in following situations:

SUPPOSE:

Plaintiff and defendant entered into a nondisclosure agreement.
Plaintiff adopted security measures.
Cf. *Eastern Marble Products Corp. V. Roman Marble, Inc.*
364 N.E.2d 799 (Mass. 1977)

Defendant's access to plaintiff's product information saved it time or expense.
Plaintiff and defendant entered into a nondisclosure agreement.
Cf. *Telex Corp. V. Ibm Corp.* (1)
510 F.2d 894 (10 Cir., 1975)

Plaintiff and defendant entered into a nondisclosure agreement.
Defendant's access to plaintiff's product information saved it time or expense.
Cf. *Kewanee Oil Co. V. Bicron Corp.*
416 U.S. 470, 94 S.Ct. 1879, 40 L.Ed.2d 315 (1974)

Defendant's access to plaintiff's product information saved it time or expense.
Plaintiff and defendant entered into a nondisclosure agreement.
Cf. *Analogic Corp. V. Data Translation, Inc.*
358 N.E.2d 804 (S.J.C., Mass., 1976)

Defendant's access to plaintiff's product information saved it time or expense.
Plaintiff adopted security measures.
Cf. *Space Aero Products Co. V. R.E. Darling Co.*
208 A.2d 74 (Ct.App., Md., 1965)

Plaintiff's disclosures to outsiders were restricted.

**Cf. Data General Corp. V. Digital Computer Controls Inc.
357 A.2d 105 (Del. Ch. 1975)**

DEFENDANT's position would be strengthened in following situations:

SUPPOSE:

**Plaintiff's product information was about customer business relations.
Cf. Automated-Systems V. Service-Bureau
401 F.2d 619 (10 Cir., 1968)**

Comparisons of *Crown* to *Crown* Variant 4:

**On a claim for TRADE-SECRETS-MISAPPROPRIATION,
DEFENDANT in *Crown Industries Inc. V. Kawneer Co.*-4
can make a stronger response to a point citing
Midland-Ross Corp. V. Sunbeam Equipment Corp.
than in *Crown Industries Inc. V. Kawneer Co.*
because it can cite the following additional more on point counter-examples:
Data General Corp. V. Digital Computer Controls Inc.
357 A.2d 105 (Del. Ch. 1975)**

Compare the following arguments:

This is the point in Crown Industries Inc. V. Kawneer Co.

[1]

==> POINT for DEFENDANT as Side-1:

WHERE:

Plaintiff disclosed its product information to outsiders.

DEFENDANT should win a claim for TRADE-SECRETS-MISAPPROPRIATION.

CITE: Midland-Ross Corp. V. Sunbeam Equipment Corp.
316 F. Supp 171 (W.D. Pa., 1970).

<== RESPONSE for PLAINTIFF as Side-2:

Midland-Ross Corp. V. Sunbeam Equipment Corp. is distinguishable because:

In Midland Ross, plaintiff disclosed its product information to more outsiders than in Crown Industries

COUNTER-EXAMPLES:

Data General Corp. V. Digital Computer Controls Inc.
357 A.2d 105 (Del. Ch. 1975), held for PLAINTIFF
even though in Data General plaintiff disclosed its product information to more outsiders than in Midland-Ross Corp. V. Sunbeam Equipment Corp..

==> REBUTTAL for DEFENDANT as Side-1:

Data General Corp. V. Digital Computer Controls Inc. is distinguishable because:

In Crown Industries, Plaintiff disclosed its product information in negotiations with defendant. Not so in Data General.

In Data General, plaintiff's disclosures to outsiders were restricted. Not so in Crown Industries.

NOTE:

PLAINTIFF's response would be strengthened if:

Plaintiff's disclosures to outsiders were restricted.

Cf. Data General Corp. V. Digital Computer Controls Inc.
357 A.2d 105 (Del. Ch. 1975)

This is the point in Crown Industries Inc. V. Kawneer Co.-4

[5]

==> POINT for DEFENDANT as Side-1:

WHERE:

Plaintiff disclosed its product information to outsiders.

DEFENDANT should win a claim for TRADE-SECRETS-MISAPPROPRIATION.

CITE: Midland-Ross Corp. V. Sunbeam Equipment Corp.
316 F. Supp 171 (W.D. Pa., 1970).

<== RESPONSE for PLAINTIFF as Side-2:

Midland-Ross Corp. V. Sunbeam Equipment Corp. is distinguishable because:

In Midland Ross, plaintiff disclosed its product information to more outsiders than in Crown Industries-4

COUNTER-EXAMPLES:

Data General Corp. V. Digital Computer Controls Inc.
357 A.2d 105 (Del. Ch. 1975), is more on point and held for PLAINTIFF where it was also the case that:
Plaintiff's disclosures to outsiders were restricted.

Data General Corp. V. Digital Computer Controls Inc.
357 A.2d 105 (Del. Ch. 1975), held for PLAINTIFF even though in Data General plaintiff disclosed its product information to more outsiders than in Midland-Ross Corp. V. Sunbeam Equipment Corp..

==> REBUTTAL for DEFENDANT as Side-1:
None.

Citation Summary for Version-4 of *Crown*:

**3-Ply Arguments for Best Cases to Cite
on Claim of TRADE-SECRETS-MISAPPROPRIATION
in Fact Situation of Crown Industries-4:**

**On a claim for TRADE-SECRETS-MISAPPROPRIATION,
both sides can make a strong argument.**

**PLAINTIFF can cite the following cases
for which there are
no more on point counter-examples:**

**Data General Corp. V. Digital Computer Controls Inc.
357 A.2d 105 (Del. Ch. 1975)**

**DEFENDANT can cite the following cases
for which there are
no more on point counter-examples:**

**Speedry Chemical Products, Inc. V. Carter'S Ink Company
306 F.2d 328 (2d Cir., 1962)**

**Automated-Systems V. Service-Bureau
401 F.2d 619 (10 Cir., 1968)**

5.2 The *Amexco* Example

The second extended example involves the *Amexco* fact situation of Chapter 3 involving G. Whiz, the Amexco employee who came up with an oil drill analysis program that EXXSSInc has its eye on. See Chapter 3 for a summary of the fact situation.

The contents of the *Amexco* extended example are as follows:

1. Section 5.2.1 presents the the case representation for the fact situation.
2. Section 5.2.2 shows the completed case analysis record, including the interpretation frame and results of best case selection.
3. Section 5.2.4 presents the Argument Records.
4. The Citation Summary, 3-Ply Arguments and suggested hypotheticals are in Section 5.2.5.

By way of commentary, here are some additional features of HYPO's arguments that were not present in the *Crown* extended example.

Since the *Amexco* fact situation involves the common employee scenario, the situation where a former employee of plaintiff brings the secret to his subsequent employer, the defendant, the case representation shows legal case frames not present in the *Crown* example such as EMPLOYEE-PARTY, EMPLOYMENT, EMPLOYMENT-CHANGE, and PRODUCT-WORKED-ON. It also shows a NON-DISCLOSURE-AGREEMENT between G. Whiz and Amexco, his former employer. Similarly, the interpretation frame reflects values for the factual predicates associated with the employee scenario and nondisclosure agreement, such as CORP2-ACCESS-PRODUCT1-VIA-EMPLOYEE1 and NONDISCLOSURE-AGREEMENT-RE-CORP2-ACCESS.

As the claim-lattice of Section 5.2.3 indicates, the *Amoco* and *Eastern Marble* cases are the most on point case for Δ . *Structural Dynamics* is the most on point case for Π . Indeed, *Amexxco* is nearly identical to the *Amoco* case (on which it was patterned.) In Chapter 10 we will compare the arguments that the court made in the *Amoco* case with those that HYPO made for *Amexxco*.

HYPO's Citation Summary in Section 5.2.5 shows that this time, there are strong arguments to be made on both sides. Arguments [1] through [3] are the arguments that HYPO makes spontaneously from the list of best cases. Arguments [4] and [5] were made by HYPO from cases selected by the attorney from the claim-lattice to illustrate how the responses to the cases both distinguish them and cite a trumping counter-example to each, the *Structural Dynamics* case. Note that the points and responses involve different dimensions than those of the *Crown* example.

HYPO poses suggested hypotheticals to strengthen each side's position. These come from the most-on-point near-miss cases of the case-analysis-record and were garnered from the extended claim-lattice which is not shown.

5.2.1 Case Representation of Amexxco

<CASE : Amexxco Production Co. v. Gwhiz>

NAME: Amexxco Production Co. v. Gwhiz

SHORT-TITLE: "Amexxco"

CITATION: "hypothetical case"

DATE: (1987)

PARTY-LIST:

(<CORPORATE-PARTY : AMEXXCO>
 <CORPORATE-PARTY : EXXSSINC>
 <EMPLOYEE-PARTY : GWHIZ>)

ROLE-PARTY-ALIST:

((PLAINTIFF <CORPORATE-PARTY : AMEXXCO>
 (DEFENDANT <CORPORATE-PARTY : EXXSSINC> <EMPLOYEE-PARTY
 : GWHIZ>))

DECISION-FOR: NIL

CLAIMS-HELD-FOR: NIL

CLAIM-OR-DEFENSE-LIST: NIL

DIMENSIONS-LIST: NIL

CLAIM-DIMENSIONS-ALIST: NIL

DIMENSIONS-HELD-FOR-ALIST: NIL

CASES-CITED: NIL

<CORPORATE-PARTY : AMEXXCO>

NAME: AMEXXCO

CASE-ROLE: (PLAINTIFF)

CASE: <CASE : Amexxco Production Co. v. Gwhiz>

EMPLOYEE-LIST: (<EMPLOYMENT : OF-GWHIZ-BY-AMEXXCO>)

COMPETITOR-PRODUCT-ALIST:

((<CORPORATE-PARTY : EXXSSINC> <PRODUCT : EXXSSINC-SYSTEM>))

PRODUCT-LIST: (<PRODUCT : DIPPER>)

<CORPORATE-PARTY : EXXSSINC>

NAME: EXXSSINC

CASE-ROLE: (DEFENDANT)

CASE: <CASE : Amexxco Production Co. v. Gwhiz>
 EMPLOYEE-LIST: (<EMPLOYMENT : OF-GWHIZ-BY-EXXSSINC>)
 COMPETITOR-PRODUCT-ALIST:
 ((<CORPORATE-PARTY : AMEXXCO> <PRODUCT : DIPPER>))
 PRODUCT-LIST: (<PRODUCT : EXXSSINC-SYSTEM>)

<EMPLOYEE-PARTY : GWHIZ>

NAME: GWHIZ
 CASE-ROLE: (DEFENDANT)
 CASE: <CASE : Amexxco Production Co. v. Gwhiz>
 EMPLOYMENT-LIST:
 (<EMPLOYMENT : OF-GWHIZ-BY-AMEXXCO>
 <EMPLOYMENT : OF-GWHIZ-BY-EXXSSINC>)
 EMPLOY*ER-*MENT-ALIST:
 ((<CORPORATE-PARTY : AMEXXCO> <EMPLOYMENT : OF-GWHIZ-
 BY-AMEXXCO>)
 (<CORPORATE-PARTY : EXXSSINC> <EMPLOYMENT : OF-GWHIZ-
 BY-EXXSSINC>))

<EMPLOYMENT : OF-GWHIZ-BY-AMEXXCO>

NAME: OF-GWHIZ-BY-AMEXXCO
 CASE: <CASE : Amexxco Production Co. v. Gwhiz>
 EMPLOYEE: (<EMPLOYEE-PARTY : GWHIZ>)
 EMPLOYER: (<CORPORATE-PARTY : AMEXXCO>)
 STARTING-DATE: (1980)
 ENDING-DATE: (1987)
 EX-COVENANT-NOT-TO-COMPETE: NIL
 EX-CHANGE-OF-EMPLOYERS:
 (<EMPLOYMENT-CHANGE : OF-GWHIZ-FROM-AMEXXCO-TO-EXXSSINC>)
 PRODUCT-WORKED-ON-LIST: (<PRODUCT-WORKED-ON : WORK-ON-
 DIPPER>)

<EMPLOYMENT : OF-GWHIZ-BY-EXXSSINC>

NAME: OF-GWHIZ-BY-EXXSSINC
 CASE: <CASE : Amexxco Production Co. v. Gwhiz>
 EMPLOYEE: (<EMPLOYEE-PARTY : GWHIZ>)

EMPLOYER: (<CORPORATE-PARTY : EXXSSINC>)
 STARTING-DATE: (1987)
 ENDING-DATE: NIL
 EX-COVENANT-NOT-TO-COMPETE: NIL
 EX-CHANGE-OF-EMPLOYERS:
 (<EMPLOYMENT-CHANGE : OF-GWHIZ-FROM-AMEXXCO-TO-EXXSSINC>)
 PRODUCT-WORKED-ON-LIST:
 (<PRODUCT-WORKED-ON : WORK-ON-EXXSSINC-SYSTEM>)

<EMPLOYMENT-CHANGE : OF-GWHIZ-FROM-AMEXXCO-TO-EXXSSINC>

NAME: OF-GWHIZ-FROM-AMEXXCO-TO-EXXSSINC
 CASE: <CASE : Amexxco Production Co. v. Gwhiz>
 FORMER-EMPLOYER: (<CORPORATE-PARTY : AMEXXCO>)
 FORMER-EMPLOYMENT: (<EMPLOYMENT : OF-GWHIZ-BY-AMEXXCO>)
 VALUE-RECEIVED-TO-MAKE-CHANGE-LIST: NIL
 RECORDS-DEVICES-CODE-BROUGHT-BY-EMPLOYMENT-LIST: NIL

<PRODUCT : DIPPER>

NAME: DIPPER
 CASE: <CASE : Amexxco Production Co. v. Gwhiz>
 A-KIND-OF: (WELL-LOG-ANALYZER)
 PRODUCT-USED-FOR: ("analysing oil wells")
 GENERAL-PRODUCT-MARKET: (OIL-COMPANIES)
 TECHNOLOGY-USED: NIL
 COMPARISON-W-GENERALLY-AVAILABLE-COMPETITIVE-PRODUCTS: NIL
 COMPETITORS-PRODUCT-ALIST:
 ((<CORPORATE-PARTY : EXXSSINC> <PRODUCT : EXXSSINC-SYSTEM>))
 DEVELOPER: (<CORPORATE-PARTY : AMEXXCO>)
 CUSTOMER-LIST: NIL
 EMPLOYMENT-WORKED-ON-PROJECT-LIST:
 (<EMPLOYMENT : OF-GWHIZ-BY-AMEXXCO>)
 PROJECT-DEVELOPMENT-START: NIL
 PROJECT-DEVELOPMENT-END: NIL
 PROJECT-DEVELOPMENT-TIME: NIL
 EXPENDITURES-MADE: NIL
 KNOWLEDGE-USED: (<KNOWLEDGE : ABOUT-DIPPER>)

SECURITY-MEASURES-LIST: (*MINIMAL-MEASURES*)
 SECURITY-BREACH-LIST: NIL
 EX-INTRINSIC-SIMILARITIES-WITH-COMPETITIVE-PRODUCT: NIL

<PRODUCT : EXXSSINC-SYSTEM>

NAME: EXXSSINC-SYSTEM
 CASE: <CASE : Amexxco Production Co. v. Gwhiz>
 A-KIND-OF: (WELL-LOG-ANALYZER)
 PRODUCT-USED-FOR: ("analysing oil wells")
 GENERAL-PRODUCT-MARKET: (OIL-COMPANIES)
 TECHNOLOGY-USED: (TECHNICAL)
 COMPARISON-W-GENERALLY-AVAILABLE-COMPETITIVE-PRODUCTS: NIL
 COMPETITORS-PRODUCT-ALIST:
 ((<CORPORATE-PARTY : AMEXXCO> <PRODUCT : DIPPER>))
 DEVELOPER: (<CORPORATE-PARTY : EXXSSINC>)
 CUSTOMER-LIST: NIL
 EMPLOYMENT-WORKED-ON-PROJECT-LIST:
 ((<EMPLOYMENT : OF-GWHIZ-BY-EXXSSINC>))
 PROJECT-DEVELOPMENT-START: NIL
 PROJECT-DEVELOPMENT-END: NIL
 PROJECT-DEVELOPMENT-TIME: NIL
 EXPENDITURES-MADE: NIL
 KNOWLEDGE-USED: (<KNOWLEDGE : ABOUT-DIPPER>)
 SECURITY-MEASURES-LIST: NIL
 SECURITY-BREACH-LIST: NIL
 EX-INTRINSIC-SIMILARITIES-WITH-COMPETITIVE-PRODUCT: NIL

<PRODUCT-WORKED-ON : WORK-ON-DIPPER>

NAME: WORK-ON-DIPPER
 CASE: <CASE : Amexxco Production Co. v. Gwhiz>
 PRODUCT: (<PRODUCT : DIPPER>)
 EMPLOYMENT: (<EMPLOYMENT : OF-GWHIZ-BY-AMEXXCO>)
 KNOWLEDGE-EMPLOYED-LIST: (<KNOWLEDGE : ABOUT-DIPPER>)
 EMPLOYEE-ROLE-IN-PRODUCT-DEVELOPMENT: (SOLE-DEVELOPER)

<PRODUCT-WORKED-ON : WORK-ON-EXXSSINC-SYSTEM>

NAME: WORK-ON-EXXSSINC-SYSTEM

CASE: <CASE : Amexxco Production Co. v. Gwhiz>
 PRODUCT: (<PRODUCT : EXXSSINC-SYSTEM>)
 EMPLOYMENT: (<EMPLOYMENT : OF-GWHIZ-BY-EXXSSINC>)
 KNOWLEDGE-EMPLOYED-LIST: (<KNOWLEDGE : ABOUT-DIPPER>)
 EMPLOYEE-ROLE-IN-PRODUCT-DEVELOPMENT: NIL

<KNOWLEDGE : ABOUT-DIPPER>

NAME: ABOUT-DIPPER
 CASE: <CASE : Amexxco Production Co. v. Gwhiz>
 KNOWLEDGE-ABOUT: (<PRODUCT : DIPPER>)
 KIND-OF-KNOWLEDGE: (TECHNICAL)
 PARTY-WITH-ACCESS-LIST:
 (<CORPORATE-PARTY : AMEXXCO>
 <CORPORATE-PARTY : EXXSSINC>
 <EMPLOYEE-PARTY : GWHIZ>)
 OTHER-PERSON-WITH-ACCESS-LIST: NIL
 NUMBER-PERSONS-WITH-ACCESS: NIL
 SPECIFIC-DISCLOSURE-EVENTS:
 (<DISCLOSURE-EVENT : AMEXXCO-DISCLOSES-TO-EXXSSINC-VIA-GWHIZ>)
 NUMBER-DISCLOSEES: NIL
 PERCENT-DISCLOSEES-RESTRICTED: NIL
 DISCLOSURE-RESTRICTION: T
 GENERALLY-KNOWN-IN-INDUSTRY: NIL

<NONDISCLOSURE-AGREEMENT : BETWEEN-GWHIZ-AND-AMEXXCO-2>

NAME: BETWEEN-GWHIZ-AND-AMEXXCO-2
 CASE: <CASE : Amexxco Production Co. v. Gwhiz>
 DISCLOSER: (<CORPORATE-PARTY : AMEXXCO>)
 DISCLOSEE: (<EMPLOYEE-PARTY : GWHIZ>)
 PARTY-CONSIDERATION-ALIST:
 ((<CORPORATE-PARTY : AMEXXCO> *PROMISE*)
 (<EMPLOYEE-PARTY : GWHIZ> EMPLOYMENT))
 SPECIFIC-RE-INFO: *NEGATIVE*
 DURATION-OF-PROHIBITION: NIL
 SUBSTANCE-OF-PROHIBITION: NIL
 PARTIES-TO:

(<CORPORATE-PARTY : AMEXXCO> <EMPLOYEE-PARTY : GWHIZ>)
PARTY-RELIANCE-ALIST: NIL
EXPRESS-OR-IMPLIED: (EXPRESS)
DATE-ENTERED: NIL

<DISCLOSURE-EVENT : AMEXXCO-DISCLOSES-TO-EXXSSINC-VIA-GWHIZ>

NAME: AMEXXCO-DISCLOSES-TO-EXXSSINC-VIA-GWHIZ
CASE: <CASE : Amexxco Production Co. v. Gwhiz>
INFO-DISCLOSED: (<KNOWLEDGE : ABOUT-DIPPER>)
DISCLOSER: (<CORPORATE-PARTY : AMEXXCO>)
DISCLOSEE: (<CORPORATE-PARTY : EXXSSINC>)
HOW-DISCLOSURES-MADE:
(<EMPLOYMENT-CHANGE : OF-GWHIZ-FROM-AMEXXCO-TO-EXXSSINC>)
TIME-TO-GENERATE-INFO-FROM-DISCLOSURE: NIL
NONDISCLOSURE-AGREEMENTS:
<NONDISCLOSURE-AGREEMENT : BETWEEN-GWHIZ-AND-AMEXXCO-
2>

5.2.2 Dimensional Analysis of *Amexxco* and Best Case Selection

Case Analysis Record

<ACR : AMEXXCO PRODUCTION CO. V. GWHIZ : ACR>

NAME: AMEXXCO PRODUCTION CO. V. GWHIZ : ACR

CASE: <CASE : Amexxco Production Co. v. Gwhiz>

INTERP-FRAME: <INTERP-FRAME : AMEXXCO PRODUCTION CO. V. GWHIZ >

CLAIM-LATTICES:

((<TYPE-OF-CLAIM : TRADE-SECRETS-MISAPPROPRIATION>
 <GRAPH-NODE-654>
 (<TYPE-OF-CLAIM : BREACH-NONDISCLOSE-NONCOMPETE-AGREEMENT>
 <GRAPH-NODE-647>
 (<TYPE-OF-CLAIM : BREACH-OF-CONTRACT> <GRAPH-NODE-640>)))

EXTENDED-CLAIM-LATTICES:

((<TYPE-OF-CLAIM : TRADE-SECRETS-MISAPPROPRIATION>
 <GRAPH-NODE-687>
 (<TYPE-OF-CLAIM : BREACH-NONDISCLOSE-NONCOMPETE-AGREEMENT>
 <GRAPH-NODE-679>
 (<TYPE-OF-CLAIM : BREACH-OF-CONTRACT> <GRAPH-NODE-672>)))

MOST-ON-POINT-CASES-BY-CLAIM:

((<TYPE-OF-CLAIM : BREACH-OF-CONTRACT>
 (PLAINTIFF <CASE : Laff v. John O. Butler Co.>
 (DEFENDANT
 <CASE : dougherty v. salt>
 <CASE : hancock bank & trust co. v. shell oil co.>
 <CASE : akirksey v. kirksey>)))
 (<TYPE-OF-CLAIM : BREACH-NONDISCLOSE-NONCOMPETE-AGREEMENT>
 (PLAINTIFF
 <CASE : modern controls inc. v. andreadakis>
 <CASE : structural dynamics research corp. v.
 engineering mechanics research corp.>)
 (DEFENDANT
 <CASE : Motorola, Inc. v. Fairchild Camera and Instrument
 Corp.>)))

(<TYPE-OF-CLAIM : TRADE-SECRETS-MISAPPROPRIATION>
 (PLAINTIFF
 <CASE : Eastern Marble Products Corp. v. Roman Marble, Inc.>
 <CASE : structural dynamics research corp. v.
 engineering mechanics research corp.>)
 (DEFENDANT
 <CASE : Amoco Production Co. v. Lindley>)))

MOST-ON-POINT-NEAR-MISS-CASES-BY-CLAIM:

((<TYPE-OF-CLAIM : BREACH-OF-CONTRACT>
 (PLAINTIFF) (DEFENDANT))
 (<TYPE-OF-CLAIM : BREACH-NONDISCLOSE-NONCOMPETE-AGREEMENT>
 (PLAINTIFF) (DEFENDANT))
 (<TYPE-OF-CLAIM : TRADE-SECRETS-MISAPPROPRIATION>
 (PLAINTIFF
 <CASE : Analogic Corp. v. Data Translation, Inc.>
 <CASE : Space Aero Products Co. v. R.E. Darling Co.>
 <CASE : telex corp. v. ibm corp. (1)>
 <CASE : structural dynamics research corp. v.
 engineering mechanics research corp.>)
 (DEFENDANT
 <CASE : Crown Industries Inc. v. Kawneer Co.>
 <CASE : midland-ross corp. v. yokana>
 <CASE : Automated-Systems v. Service-Bureau>
 <CASE : Midland-Ross Corp. v. Sunbeam Equipment Corp.>)))

BEST-CASES-BY-CLAIM:

((<TYPE-OF-CLAIM : BREACH-OF-CONTRACT>
 (PLAINTIFF
 <CASE : Laff v. John O. Butler Co.>) (DEFENDANT))
 (<TYPE-OF-CLAIM : BREACH-NONDISCLOSE-NONCOMPETE-AGREEMENT>
 (PLAINTIFF
 <CASE : modern controls inc. v. andreadakis>
 <CASE : structural dynamics research corp. v.
 engineering mechanics research corp.>)
 (DEFENDANT))
 (<TYPE-OF-CLAIM : TRADE-SECRETS-MISAPPROPRIATION>
 (PLAINTIFF
 <CASE : Eastern Marble Products Corp. v. Roman Marble, Inc.>
 <CASE : structural dynamics research corp. v.
 engineering mechanics research corp.>))

(DEFENDANT <CASE : Amoco Production Co. v. Lindley>)))

APPLICABLE-DIMENSIONS:

(<DIMENSION : AGREEMENT-SUPPORTED-BY-CONSIDERATION>
<DIMENSION : SECURITY-MEASURES-ADOPTED>
<DIMENSION : NONDISCLOSURE-AGREEMENT-SPECIFIC>
<DIMENSION : COMMON-EMPLOYEE-SOLE-DEVELOPER>
<DIMENSION : NONDISCLOSURE-AGREEMENT-RE-DEFENDANT-ACCESS>)

NEAR-MISS-DIMENSIONS:

(<DIMENSION : COMMON-EMPLOYEE-TRANSFERRED-PRODUCT-TOOLS>
<DIMENSION : COMMON-EMPLOYEE-PAID-TO-CHANGE-EMPLOYERS>
<DIMENSION : SECRETS-VOLUNTARILY-DISCLOSED>
<DIMENSION : COMPETITIVE-ADVANTAGE-GAINED>
<DIMENSION : VERTICAL-KNOWLEDGE>
<DIMENSION : DISCLOSURE-IN-NEGOTIATIONS-WITH-DEFENDANT>)

POINTS:

(<ARG-REC-25> <ARG-REC-24> <ARG-REC-23>
<ARG-REC-22> <ARG-REC-21>)

Interpretation Frame for *Amexxco*

<INTERP-FRAME : AMEXXCO PRODUCTION CO. V. GWHIZ >

NAME: AMEXXCO PRODUCTION CO. V. GWHIZ : INTERP-FRAME
 CASE: <CASE : Amexxco Production Co. v. Gwhiz>
 EXISTS-CLAIMANT-CORP1: <CORPORATE-PARTY : AMEXXCO>
 CLAIMANT-MAKES-PRODUCT1: <PRODUCT : DIPPER>
 EXISTS-CLAIMANTS-INFO-RE-PRODUCT1:
 <KNOWLEDGE : ABOUT-DIPPER>
 EXISTS-RESPONDENT-CORP2: <CORPORATE-PARTY : EXXSSINC>
 RESPONDENT-MAKES-PRODUCT2: <PRODUCT : EXXSSINC-SYSTEM>
 CORPS-1-2-COMPETE: T
 CORPS-1-2-COMPETE-RE-PRODUCTS-1-2: T
 EXISTS-RESPONDENT-EMPLOYEE1: <EMPLOYEE-PARTY : GWHIZ>
 EMPLOYEE1-WORKED-FOR-CLAIMANT:
 <EMPLOYMENT : OF-GWHIZ-BY-AMEXXCO>
 EMPLOYEE1-WORKED-FOR-RESPONDENT:
 <EMPLOYMENT : OF-GWHIZ-BY-EXXSSINC>
 EXISTS-COMMON-EMPLOYEE1: T
 EXISTS-EMPLOYMENT-CHANGE:
 <EMPLOYMENT-CHANGE : OF-GWHIZ-FROM-AMEXXCO-TO-EXXSSINC>
 EMPLOYEE-PAID-TO-SWITCH: NIL
 EMPLOYEE-BROUGHT-PRODUCT-TOOLS: NIL
 EMPLOYEE-WORKED-ON-PRODUCT1:
 <PRODUCT-WORKED-ON : WORK-ON-DIPPER>
 CORP2-ACCESS-PRODUCT1-VIA-EMPLOYEE1:
 <DISCLOSURE-EVENT : AMEXXCO-DISCLOSES-TO-EXXSSINC-VIA-GWHIZ>
 CORP1-EMPLOYEE1-AGREEMENT: NIL
 EXISTS-PERSON-ASSERTING-CONTRACT: <CORPORATE-PARTY : AMEXXCO>
 EXISTS-PERSON-DENYING-CONTRACT: <EMPLOYEE-PARTY : GWHIZ>
 EXISTS-PURPORTED-AGREEMENT:
 <NONDISCLOSURE-AGREEMENT : BETWEEN-GWHIZ-AND-AMEXXCO-
 2>
 EXISTS-DISCLOSURES-INFO1: NIL
 KNOW-WHAT-KIND-INFO1: NIL
 CORP2-SAVED-EXPENSE: *NEGATIVE*
 EXISTS-RESTRICTIONS-DISCLOSURES-INFO1: NIL
 EXISTS-INFO-RE-SECURITY-MEASURES: (*MINIMAL-MEASURES*)
 INFO1-DISCLOSED-CORPS-1-2-NEGOTIATIONS: NIL

CORP2-ACCESS-INFO1-VIA-DISCLOSURE:

(<DISCLOSURE-EVENT : AMEXXCO-DISCLOSES-TO-EXXSSINC-VIA-GWHIZ>)

NONDISCLOSURE-AGREEMENT-RE-CORP2-ACCESS:

(<NONDISCLOSURE-AGREEMENT : BETWEEN-GWHIZ-AND-AMEXXCO-2>)

EXISTS-DATA-RE-SPECIFICITY: (*NEGATIVE*)

EXISTS-DATA-RE-SOLE-DEVELOPER: (SOLE-DEVELOPER)

5.2.3 Positioning *Amexxco*

(See Figure 15 below.)

5.2.4 Argument Records for *Amexxco*

<ARG-REC-21>
 NAME: ARG-REC-21
 CFS: <CASE : Amexxco Production Co. v. Gwhiz>
 CFS-ACR:
 <ACR : AMEXXCO PRODUCTION CO. V. GWHIZ : ACR>
 SIDE-1: PLAINTIFF
 CLAIM:
 <TYPE-OF-CLAIM : TRADE-SECRETS-MISAPPROPRIATION>
 CITED-CASE-ACR:
 <ACR : EASTERN MARBLE PRODUCTS CORP. V. ROMAN MARBLE,
 INC. :
 ACR>
 CITED-CASE:
 <CASE : Eastern Marble Products Corp. v. Roman Marble, Inc.>
 SHARED-DIMENSIONS:
 (<DIMENSION : SECURITY-MEASURES-ADOPTED>
 <DIMENSION : NONDISCLOSURE-AGREEMENT-RE-DEFENDANT-ACCESS>)
 SIDE-2-DISTINCTIONS:
 ((:WEAKER <CASE : Amexxco Production Co. v. Gwhiz>
 <CASE : Eastern Marble Products Corp. v. Roman Marble, Inc.>
 <DIMENSION : SECURITY-MEASURES-ADOPTED>
 LESS (*MINIMAL-MEASURES*)
 (*MINIMAL-MEASURES*
 EMPLOYEE-NONDISCLOSURE-AGREEMENTS
 RESTRICTIONS-ON-ENTRY-BY-VISITORS)))
 (:STRONG <CASE : Amexxco Production Co. v. Gwhiz>
 <DIMENSION : COMMON-EMPLOYEE-SOLE-DEVELOPER>))
 MOP-COUNTER-EXMPL: (<CASE : Amoco Production Co. v. Lindley>)
 AS-OP-COUNTER-EXMPL: NIL
 POTENT-COUNTER-EXMPL: NIL
 OVERLAP-COUNTER-EXMPL: NIL
 BOUNDARY-COUNTER-EXMPL: NIL
 LESS-ON-POINT-CON-CASES: NIL
 SIDE-1-HYPOS: NIL
 SIDE-2-HYPOS: NIL
 RESPONSIVE-ARG-RECS: (<ARG-REC-22>)

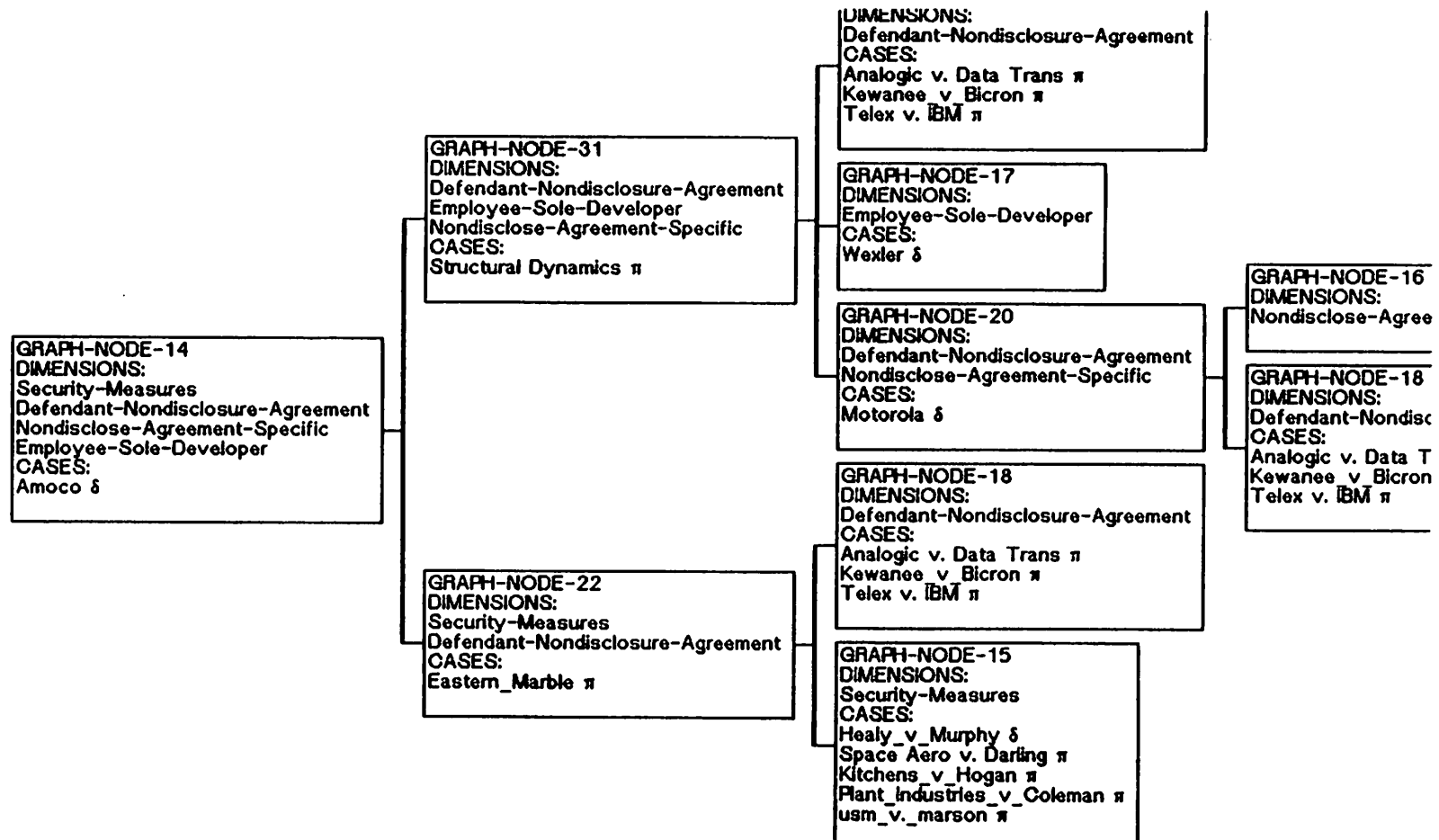

Figure 15: Claim-Lattice for Trade Secrets Claim in Amexco Example

<ARG-REC-22>

NAME: ARG-REC-22

CFS: <CASE : Amexxco Production Co. v. Gwhiz>

CFS-ACR: <ACR : AMEXXCO PRODUCTION CO. V. GWHIZ : ACR>

SIDE-1: DEFENDANT

CLAIM:

<TYPE-OF-CLAIM : TRADE-SECRETS-MISAPPROPRIATION>

CITED-CASE-ACR:

<ACR : AMOCO PRODUCTION CO. V. LINDLEY : ACR>

CITED-CASE: <CASE : Amoco Production Co. v. Lindley>

SHARED-DIMENSIONS:

(<DIMENSION : SECURITY-MEASURES-ADOPTED>

<DIMENSION : COMMON-EMPLOYEE-SOLE-DEVELOPER>

<DIMENSION : NONDISCLOSURE-AGREEMENT-RE-DEFENDANT-ACCESS>)

SIDE-2-DISTINCTIONS: NIL

MOP-COUNTER-EXMPL: NIL

AS-OP-COUNTER-EXMPL: NIL

POTENT-COUNTER-EXMPL: NIL

OVERLAP-COUNTER-EXMPL: NIL

BOUNDARY-COUNTER-EXMPL: NIL

LESS-ON-POINT-CON-CASES: NIL

SIDE-1-HYPOS: NIL

SIDE-2-HYPOS: NIL

RESPONSIVE-ARG-RECS: NIL

<ARG-REC-23>

NAME: ARG-REC-23

CFS: <CASE : Amexxco Production Co. v. Gwhiz>

CFS-ACR: <ACR : AMEXXCO PRODUCTION CO. V. GWHIZ : ACR>

SIDE-1: PLAINTIFF

CLAIM: <TYPE-OF-CLAIM : TRADE-SECRETS-MISAPPROPRIATION>

CITED-CASE-ACR:

<ACR : STRUCTURAL DYNAMICS RESEARCH CORP. V. ENGINEERING
MECHANICS RESEARCH CORP. : ACR>

CITED-CASE:

<CASE : structural dynamics research corp. v. engineering
mechanics research corp.>

SHARED-DIMENSIONS:

(<DIMENSION : COMMON-EMPLOYEE-SOLE-DEVELOPER>

<DIMENSION : NONDISCLOSURE-AGREEMENT-RE-DEFENDANT-ACCESS>)

SIDE-2-DISTINCTIONS:

((:STRONG

<CASE : structural dynamics research corp. v. engineering
mechanics research corp.>

<DIMENSION : AGREEMENT-SUPPORTED-BY-CONSIDERATION>)

(:STRONG

<CASE : structural dynamics research corp. v. engineering
mechanics research corp.>

<DIMENSION : COMMON-EMPLOYEE-TRANSFERRED-PRODUCT-TOOLS>)

(:STRONG

<CASE : structural dynamics research corp. v. engineering
mechanics research corp.>

<DIMENSION : NONDISCLOSURE-AGREEMENT-SPECIFIC>))

MOP-COUNTER-EXMPL: NIL

AS-OP-COUNTER-EXMPL: NIL

POTENT-COUNTER-EXMPL: NIL

OVERLAP-COUNTER-EXMPL: NIL

BOUNDARY-COUNTER-EXMPL: NIL

LESS-ON-POINT-CON-CASES: NIL

SIDE-1-HYPOS: NIL

SIDE-2-HYPOS: NIL

RESPONSIVE-ARG-RECS: NIL

<ARG-REC-24>

NAME: ARG-REC-24

CFS: <CASE : Amexxco Production Co. v. Gwhiz>

CFS-ACR: <ACR : AMEXXCO PRODUCTION CO. V. GWHIZ : ACR>

SIDE-1: DEFENDANT

CLAIM: <TYPE-OF-CLAIM : TRADE-SECRETS-MISAPPROPRIATION>

CITED-CASE-ACR:

<ACR : MOTOROLA, INC. V. FAIRCHILD CAMERA AND INSTRUMENT
CORP.

: ACR>

CITED-CASE:

<CASE : Motorola, Inc. v. Fairchild Camera and Instrument
Corp.>

SHARED-DIMENSIONS:

(<DIMENSION : NONDISCLOSURE-AGREEMENT-RE-DEFENDANT-ACCESS>)

SIDE-2-DISTINCTIONS:

((:STRONG <CASE : Amexxco Production Co. v. Gwhiz>
<DIMENSION : SECURITY-MEASURES-ADOPTED>))

MOP-COUNTER-EXMPL:

(<CASE : structural dynamics research corp. v. engineering
mechanics research corp.>)

AS-OP-COUNTER-EXMPL: NIL

POTENT-COUNTER-EXMPL: NIL

OVERLAP-COUNTER-EXMPL: NIL

BOUNDARY-COUNTER-EXMPL: NIL

LESS-ON-POINT-CON-CASES: NIL

SIDE-1-HYPOS: NIL

SIDE-2-HYPOS: NIL

RESPONSIVE-ARG-RECS: (<ARG-REC-23>)

<ARG-REC-25>

NAME: ARG-REC-25

CFS: <CASE : Amexxco Production Co. v. Gwhiz>

CFS-ACR: <ACR : AMEXXCO PRODUCTION CO. V. GWHIZ : ACR>

SIDE-1: DEFENDANT

CLAIM: <TYPE-OF-CLAIM : TRADE-SECRETS-MISAPPROPRIATION>

CITED-CASE-ACR: <ACR : WEXLER V. GREENBERG : ACR>

CITED-CASE: <CASE : Wexler v. Greenberg>

SHARED-DIMENSIONS: (<DIMENSION : COMMON-EMPLOYEE-SOLE-DEVELOPER>)

SIDE-2-DISTINCTIONS:

((:STRONG <CASE : Amexxco Production Co. v. Gwhiz>
<DIMENSION : NONDISCLOSURE-AGREEMENT-RE-DEFENDANT-ACCESS>)

(:STRONG <CASE : Amexxco Production Co. v. Gwhiz>
<DIMENSION : SECURITY-MEASURES-ADOPTED>))

MOP-COUNTER-EXMPL:

(<CASE : structural dynamics research corp. v. engineering
mechanics research corp.>)

AS-OP-COUNTER-EXMPL: NIL

POTENT-COUNTER-EXMPL: NIL

OVERLAP-COUNTER-EXMPL: NIL

BOUNDARY-COUNTER-EXMPL: NIL

LESS-ON-POINT-CON-CASES: NIL

SIDE-1-HYPOS: NIL

SIDE-2-HYPOS: NIL

RESPONSIVE-ARG-RECS: (<ARG-REC-23>)

5.2.5 Argument Outputs for Amexxco

Citation Summary:

**3-Ply Arguments for Best Cases to Cite
on Claim of TRADE-SECRETS-MISAPPROPRIATION
in Fact Situation of Amexxco:**

**On a claim for TRADE-SECRETS-MISAPPROPRIATION,
both sides can make a strong argument.**

**PLAINTIFF can cite the following cases
for which there are
no more on point counter-examples:**

**Structural Dynamics Research Corp. V. Engineering Mechanics Research Corp.
401 F. Supp. 1102 (E.D.Mich., 1975)**

**DEFENDANT can cite the following cases
for which there are
no more on point counter-examples:**

**Amoco Production Co. V. Lindley
609 P.2d 733**

3-Ply Arguments in Amexxco:

[1]

==> POINT for PLAINTIFF as Side-1:

WHERE:

Plaintiff and defendant entered into a nondisclosure agreement.

Plaintiff adopted security measures.

PLAINTIFF should win a claim for TRADE-SECRETS-MISAPPROPRIATION.

CITE: Eastern Marble Products Corp. V. Roman Marble, Inc.
364 N.E.2d 799 (Mass. 1977).

<== RESPONSE for DEFENDANT as Side-2:

Eastern Marble Products Corp. V. Roman Marble, Inc. is distinguishable because:

In Eastern-Marble, plaintiff adopted more security measures than in Amexxco
In Amexxco, employee defendant was sole developer of plaintiff's product. Not so
in Eastern-Marble.**COUNTER-EXAMPLES:**

Amoco Production Co. V. Lindley

609 P.2d 733, is more on point and held for DEFENDANT

where it was also the case that:

Employee defendant was sole developer of plaintiff's product.

==> REBUTTAL for PLAINTIFF as Side-1:

None.

[2]

==> POINT for PLAINTIFF as Side-1:

WHERE:

Plaintiff and defendant entered into a nondisclosure agreement.

EVEN THOUGH:

Employee defendant was sole developer of plaintiff's product.

PLAINTIFF should win a claim for TRADE-SECRETS-MISAPPROPRIATION.

CITE: Structural Dynamics Research Corp. V. Engineering Mechanics Research Corp.

401 F. Supp. 1102 (E.D.Mich., 1975).

<== RESPONSE for DEFENDANT as Side-2:

Structural Dynamics Research Corp. V. Engineering Mechanics Research Corp. is distinguishable because:

In Structural Dynamics, defendant received something of value for entering into the agreement. Not so in Amexxco.

In Structural Dynamics, plaintiff's former employee brought product development information to Defendant. Not so in Amexxco.

In Structural Dynamics, the nondisclosure agreement specifically referred to plaintiff's product. Not so in Amexxco.

==> REBUTTAL for PLAINTIFF as Side-1:

None.

[3]

==> POINT for DEFENDANT as Side-1:

WHERE:

Employee defendant was sole developer of plaintiff's product.

EVEN THOUGH:

Plaintiff and defendant entered into a nondisclosure agreement.

Plaintiff adopted security measures.

DEFENDANT should win a claim for TRADE-SECRETS-MISAPPROPRIATION.

CITE: Amoco Production Co. V. Lindley
609 P.2d 733.

<== RESPONSE for PLAINTIFF as Side-2:

None.

==> REBUTTAL for DEFENDANT as Side-1:

None.

3-Ply Arguments in Amexxco for Cases Selected by Attorney:

**3-Ply Argument for Selected Case to Cite
on Claim of TRADE-SECRETS-MISAPPROPRIATION
in Fact Situation of Amexxco:**

[4]
==> POINT for DEFENDANT as Side-1:

WHERE:

EVEN THOUGH:
Plaintiff and defendant entered into a nondisclosure agreement.

DEFENDANT should win a claim for TRADE-SECRETS-MISAPPROPRIATION.

CITE: Motorola, Inc. V. Fairchild Camera And Instrument Corp.
366 F.Supp. 1173 (D. Arizona, 1973).

<== RESPONSE for PLAINTIFF as Side-2:
Motorola, Inc. V. Fairchild Camera And Instrument Corp. is distinguishable
because:

In Amexxco, plaintiff adopted more security measures than in Motorola.

COUNTER-EXAMPLES:

Structural Dynamics Research Corp. V. Engineering Mechanics Research Corp.
401 F. Supp. 1102 (E.D.Mich., 1975), is more on point and held for PLAINTIFF
where it was also the case that:
Employee defendant was sole developer of plaintiff's product.

**==> REBUTTAL for DEFENDANT as Side-1:
Structural Dynamics Research Corp. V. Engineering Mechanics Research Corp.
is distinguishable because:**

In Structural Dynamics, defendant received something of value for entering into the agreement. Not so in Amexxco.

In Structural Dynamics, plaintiff's former employee brought product development information to Defendant. Not so in Amexxco.

In Structural Dynamics, the nondisclosure agreement specifically referred to plaintiff's product. Not so in Amexxco.

**3-Ply Argument for Selected Case to Cite
on Claim of TRADE-SECRETS-MISAPPROPRIATION
in Fact Situation of Amexxco:**

[5]

==> POINT for DEFENDANT as Side-1:

WHERE:

Employee defendant was sole developer of plaintiff's product.

DEFENDANT should win a claim for TRADE-SECRETS-MISAPPROPRIATION.

**CITE: Wexler V. Greenberg
160 A.2d 430 (Sup. Ct. Pa., 1960).**

<== RESPONSE for PLAINTIFF as Side-2:

Wexler V. Greenberg is distinguishable because:

In Amexxco, plaintiff and defendant entered into a nondisclosure agreement. Not so in Wexler.

In Amexxco, plaintiff adopted more security measures than in Wexler.

COUNTER-EXAMPLES:

**Structural Dynamics Research Corp. V. Engineering Mechanics Research Corp.
401 F. Supp. 1102 (E.D.Mich., 1975), is more on point and held for PLAINTIFF
where it was also the case that:**

Plaintiff and defendant entered into a nondisclosure agreement.

==> REBUTTAL for DEFENDANT as Side-1:

**Structural Dynamics Research Corp. V. Engineering Mechanics Research Corp.
is distinguishable because:**

In Structural Dynamics, defendant received something of value for entering into the agreement. Not so in Amexxco.

In Structural Dynamics, plaintiff's former employee brought product development information to Defendant. Not so in Amexxco.

In Structural Dynamics, the nondisclosure agreement specifically referred to plaintiff's product. Not so in Amexxco.

Suggested Hypotheticals in *Amexxco*

Hypotheticals to Consider
 on Claim of TRADE-SECRETS-MISAPPROPRIATION
 in Fact Situation of Amexxco:

PLAINTIFF's position would be strengthened in following situations:

SUPPOSE:

Defendant's access to plaintiff's product information saved it time or expense.
 Plaintiff's former employee brought product development information to defendant.
 Cf. *Analogic Corp. V. Data Translation, Inc.*
 358 N.E.2d 804 (S.J.C., Mass., 1976)

Defendant's access to plaintiff's product information saved it time or expense.
 Defendant paid plaintiff's former employee to switch employment.
 Plaintiff's former employee brought product development information to defendant.
 Cf. *Space Aero Products Co. V. R.E. Darling Co.*
 208 A.2d 74 (Ct.App., Md., 1965)

Defendant's access to plaintiff's product information saved it time or expense.
 Defendant paid plaintiff's former employee to switch employment.
 Cf. *Telex Corp. V. Ibm Corp. (1)*
 510 F.2d 894 (10 Cir., 1975)

Plaintiff's former employee brought product development information to defendant.
 Cf. *Structural Dynamics Research Corp. V. Engineering Mechanics Research Corp.*
 401 F. Supp. 1102 (E.D.Mich., 1975)

DEFENDANT's position would be strengthened in following situations:

SUPPOSE:

Plaintiff disclosed its product information in negotiations with defendant.

Plaintiff disclosed its product information to outsiders.

Cf. Crown Industries Inc. V. Kawneer Co.

335 F. Supp. 749 (N.D. Ill., 1971)

Plaintiff disclosed its product information to outsiders.

Cf. Midland-Ross Corp. V. Yokana

293 F. 2d 411 (3 Cir. 1961)

Plaintiff disclosed its product information in negotiations with defendant.

Plaintiff's product information was about customer business relations.

Cf. Automated-Systems V. Service-Bureau

401 F.2d 619 (10 Cir., 1968)

Plaintiff disclosed its product information to outsiders.

Cf. Midland-Ross Corp. V. Sunbeam Equipment Corp.

316 F. Supp 171 (W.D. Pa., 1970)

5.3 The *Structural Dynamics* Example

This extended example shows HYPO's arguments for one of the cases cited in the preceding *Amezzco* example, the *Structural Dynamics* case. Section 5.3.1 shows a squib summary for the case. HYPO's analysis of this case is included here to show:

1. HYPO can be run recursively to analyze a case cited in a previous run through the basic processing loop;
2. HYPO makes arguments for claims involving breach of contracts such as nondisclosure or noncompetition agreements as well as trade secrets misappropriation claims;
3. HYPO's output compares favorably to the actual court opinion as discussed in Chapter 10.

To conserve space, we show here only the claim-lattice (Section 5.3.2) and output of HYPO (Section 5.3.3).³ Arguments [4] and [5] and the Citation Summary show how HYPO argues the claim for breach of the nondisclosure agreement including distinguishing the citation of a classic contracts case, *Dougherty v. Salt*.

³See Chapter 8 for more discussion of best case selection in *Structural Dynamics*

5.3.1 The Squib for *Structural Dynamics*

Title: Structural Dynamics Research Corp. v. Engineering Mechanics Research Corporation

Cite: 401 F. Supp. 1102 (E.D. Mich. 1975)

Date: September 9, 1975

Parties: Π : SDRC; Δ : EMRC, Kothawala, Surana

Claim: Trade Secrets Misappropriation, Breach of Nondisclosure Agreement

Procedural Setting:

Decision: Judgment for Π in amount of 15% on all sales by EMRC for a period of three years and \$45,000 for a license fee.

Facts:

In August, 1972 SDRC began developing a computer program called NIESA to perform structural analysis using isoparametric or curved or irregularly shaped elements. SDRC began marketing its program in April, 1974. SDRC employed Kothawala between August, 1972 and December, 1972 as a member of its Technical Staff. Surana worked for SDRC from February, 1970 to January, 1973 as a project leader in the computer operations department and as a member of the Technical Staff. Each signed an Employee Patent and Confidential Information Agreement that stated:

At no time ...subsequent to termination of such employment will Employee divulge to any person, ...or use ...any privileged or confidential information, trade secret or other proprietary information relating to the experimental and research work of the Corporation, ...gained or developed by or otherwise discovered by Employee during his employment with the Company.

Surana first generated the idea for the NIESA program. Kothawala had supervisory responsibility for the project. Together they were completely responsible for the development of the program. The Court held that SDRC disclosed NIESA information to its largest shareholder and business partner. The Court held that SDRC did not take special security measures to protect the NIESA information.

The employee defendants were subsequently employed by EMRC, a company founded by Kothawala when he left SDRC in January, 1973. Kothawala

is the president and sole shareholder of EMRC; Surana is its vice-president of engineering. In March, 1973 EMRC began developing a computer program called NISA to perform structural analysis. EMRC began marketing the program in February, 1974. The Court held that defendants copied the NIESA code. The overall structure and organization of the code were similar. There were identical segments of code and identical errors. The input data cards were the same. Defendants were found to possess internal SDRC documents pertaining to the NIESA program including Surana's development notes. NISA and NIESA were functionally similar but NISA has some additional capabilities. The Court found that it would take a competitor three years to duplicate the NIESA program by independent research.

Issues:

(1) Did Δ s' development of NISA violate their nondisclosure agreement with Π regarding NIESA?

(2) Did Δ s' development of NISA misappropriate Π 's trade secrets in NIESA?

Holding: (1) Held for Π : Yes, the agreement was broad enough to apply to their development work on NIESA.

Court did not reach (2) in light of holding on (1). Court said in dicta that absent express nondisclosure agreement Δ s would have been free to use or disclose the NIESA information because they were sole developers of program.

5.3.2 Positioning *Structural Dynamics*

(See Figure 16 below.)

5.3.3 Argument Outputs for *Structural Dynamics*

Citation Summary re Trade Secrets Claim

**3-Ply Arguments for Best Cases to Cite
on Claim of TRADE-SECRETS-MISAPPROPRIATION
in Fact Situation of Structural Dynamics:**

**On a claim for TRADE-SECRETS-MISAPPROPRIATION,
both sides can make a strong argument.**

**PLAINTIFF can cite the following cases
for which there are
no more on point counter-examples:**

**Analogic Corp. V. Data Translation, Inc.
358 N.E.2d 804 (S.J.C., Mass., 1976)**

**DEFENDANT can cite the following cases
for which there are
no more on point counter-examples:**

**Amoco Production Co. V. Lindley
609 P.2d 733**

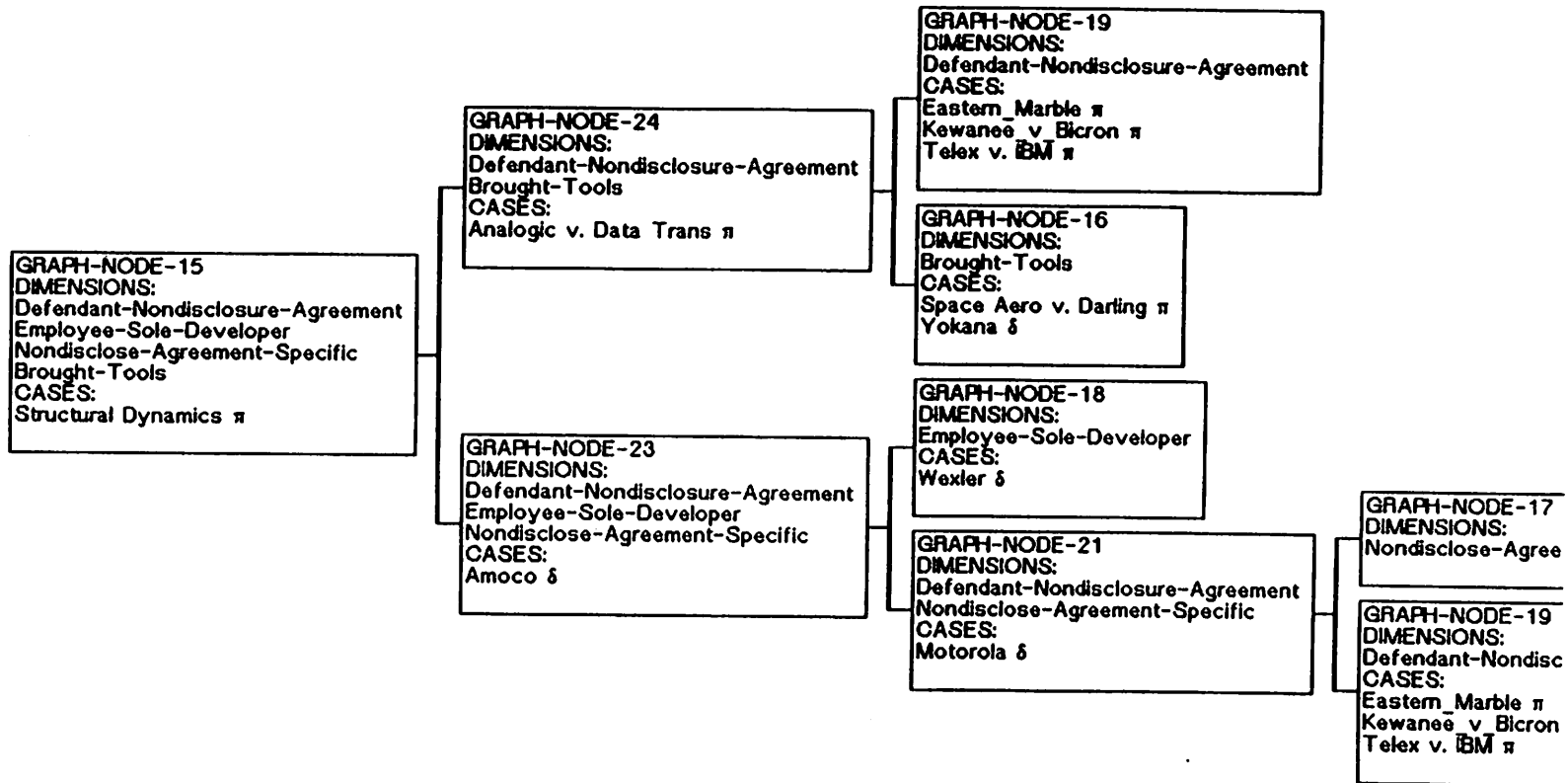

Figure 16: Claim-Lattice for Trade Secrets Claim in *Structural Dynamics* Example

3-Ply Arguments for Trade Secrets Claim in *Structural Dynamics*:

[1]

==> POINT for PLAINTIFF as Side-1:

WHERE:

Plaintiff and defendant entered into a nondisclosure agreement.

Plaintiff's former employee brought product development information to defendant.

PLAINTIFF should win a claim for TRADE-SECRETS-MISAPPROPRIATION.

CITE: Analogic Corp. V. Data Translation, Inc.
358 N.E.2d 804 (S.J.C., Mass., 1976).

<== RESPONSE for DEFENDANT as Side-2:

Analogic Corp. V. Data Translation, Inc. is distinguishable because:

In *Structural Dynamics*, employee defendant was sole developer of plaintiff's product. Not so in *Analogic V. Data Trans.*

In *Analogic V. Data Trans.*, defendant's access to plaintiff's product information saved it more time or expense than in *Structural Dynamics*.

==> REBUTTAL for PLAINTIFF as Side-1:

None.

[2]

==> POINT for DEFENDANT as Side-1:

WHERE:

Employee defendant was sole developer of plaintiff's product.

EVEN THOUGH:

Plaintiff and defendant entered into a nondisclosure agreement.

DEFENDANT should win a claim for TRADE-SECRETS-MISAPPROPRIATION.

CITE: Amoco Production Co. V. Lindley
609 P.2d 733.

<== RESPONSE for PLAINTIFF as Side-2:

Amoco Production Co. V. Lindley is distinguishable because:

In Structural Dynamics, defendant received something of value for entering into the agreement. Not so in Amoco.

In Structural Dynamics, plaintiff's former employee brought product development information to Defendant. Not so in Amoco.

In Structural Dynamics, the nondisclosure agreement specifically referred to plaintiff's product. Not so in Amoco.

==> REBUTTAL for DEFENDANT as Side-1:

None.

3-Ply Argument in *Structural Dynamics* for Cases Selected by Attorney

**3-Ply Argument for Selected Case to Cite
on Claim of TRADE-SECRETS-MISAPPROPRIATION
in Fact Situation of Structural Dynamics:**

[3]

==> POINT for DEFENDANT as Side-1:

WHERE:

Employee defendant was sole developer of plaintiff's product.

DEFENDANT should win a claim for TRADE-SECRETS-MISAPPROPRIATION.

CITE: Wexler V. Greenberg
160 A.2d 430 (Sup. Ct. Pa., 1960).

<== RESPONSE for PLAINTIFF as Side-2:
Wexler V. Greenberg is distinguishable because:

In Structural Dynamics, plaintiff's former employee brought product development information to Defendant. Not so in Wexler.

In Structural Dynamics, the nondisclosure agreement specifically referred to plaintiff's product. Not so in Wexler.

In Structural Dynamics, plaintiff and defendant entered into a nondisclosure agreement. Not so in Wexler.

==> REBUTTAL for DEFENDANT as Side-1:
None.

**3-Ply Argument for Selected Case to Cite
on Claim of TRADE-SECRETS-MISAPPROPRIATION
in Fact Situation of Structural Dynamics:**

[4]

==> POINT for PLAINTIFF as Side-1:

WHERE:

Plaintiff and defendant entered into a nondisclosure agreement.

PLAINTIFF should win a claim for TRADE-SECRETS-MISAPPROPRIATION.

CITE: Telex Corp. V. Ibm Corp. (1)
510 F.2d 894 (10 Cir., 1975).

<== RESPONSE for DEFENDANT as Side-2:

Telex Corp. V. Ibm Corp. (1) is distinguishable because:

In Structural Dynamics, employee defendant was sole developer of plaintiff's product. Not so in Telex V. Ibm.

In Telex V. Ibm, defendant's access to plaintiff's product information saved it more time or expense than in Structural Dynamics.

In Telex V. Ibm, Defendant paid plaintiff's former employee to switch employment. Not so in Structural Dynamics.

COUNTER-EXAMPLES:

Amoco Production Co. V. Lindley
609 P.2d 733, is more on point and held for DEFENDANT
where it was also the case that:
Employee defendant was sole developer of plaintiff's product.

==> REBUTTAL for PLAINTIFF as Side-1:

Amoco Production Co. V. Lindley is distinguishable because:

In Structural Dynamics, defendant received something of value for entering into the agreement. Not so in Amoco.

In Structural Dynamics, plaintiff's former employee brought product development information to Defendant. Not so in Amoco.

In Structural Dynamics, the nondisclosure agreement specifically referred to plaintiff's product. Not so in Amoco.

Citation Summary and 3-Ply Arguments for Breach of Nondisclosure Agreement in *Structural Dynamics*:

**3-Ply Arguments for Best Cases to Cite
on Claim of BREACH-NONDISCLOSE-NONCOMPETE-AGREEMENT
in Fact Situation of Structural Dynamics:**

**On a claim for BREACH-NONDISCLOSE-NONCOMPETE-AGREEMENT,
PLAINTIFF can make a stronger argument.
PLAINTIFF can cite the following cases
for which there are
no more on point counter-examples:**

**Modern Controls Inc. V. Andreadakis
578 F.2d 1264 (8 Cir., 1978)**

[5]

==> POINT for PLAINTIFF as Side-1:

WHERE:

Plaintiff and defendant entered into nondisclosure agreement.

PLAINTIFF should win a claim for BREACH-NONDISCLOSE-NONCOMPETE-AGREEMENT.

CITE: Modern Controls Inc. V. Andreadakis
578 F.2d 1264 (8 Cir., 1978).

<== RESPONSE for DEFENDANT as Side-2:

Modern Controls Inc. V. Andreadakis is distinguishable because:

In Modern Controls, defendant received something of value for entering into the agreement. Not so in Structural Dynamics

In Structural Dynamics, employee defendant was sole developer of plaintiff's product. Not so in Modern Controls.

==> REBUTTAL for PLAINTIFF as Side-1:

None.

[6]

==> POINT for DEFENDANT as Side-1:

WHERE:

Defendant received nothing of value for entering into the agreement.

DEFENDANT should win a claim for BREACH-OF-CONTRACT.

CITE: Dougherty V. Salt
227 N.Y. 200, 125 N.E. 94 (1919).

<== RESPONSE for PLAINTIFF as Side-2:
Dougherty V. Salt is distinguishable because:

In Structural Dynamics, plaintiff's former employee brought product development information to Defendant. Not so in Dougherty V. Salt.

In Structural Dynamics, the nondisclosure agreement specifically referred to plaintiff's product. Not so in Dougherty V. Salt.

In Structural Dynamics, plaintiff and defendant entered into a nondisclosure agreement. Not so in Dougherty V. Salt.

==> REBUTTAL for DEFENDANT as Side-1:
None.

Suggested Hypotheticals in *Structural Dynamics*:

Hypotheticals to Consider
on Claim of TRADE-SECRETS-MISAPPROPRIATION
in Fact Situation of Structural Dynamics:

PLAINTIFF's position would be strengthened in following situations:

SUPPOSE:

Plaintiff adopted security measures.

Cf. *Eastern Marble Products Corp. V. Roman Marble, Inc.*
364 N.E.2d 799 (Mass. 1977)

Defendant's access to plaintiff's product information saved it time or expense.

Cf. *Analogic Corp. V. Data Translation, Inc.*
358 N.E.2d 804 (S.J.C., Mass., 1976)

Defendant's access to plaintiff's product information saved it time or expense.

Plaintiff adopted security measures.

Defendant paid plaintiff's former employee to switch employment.

Cf. *Space Aero Products Co. V. R.E. Darling Co.*
208 A.2d 74 (Ct.App., Md., 1965)

Defendant's access to plaintiff's product information saved it time or expense.

Defendant paid plaintiff's former employee to switch employment.

Cf. *Telex Corp. V. Ibm Corp.* (1)
510 F.2d 894 (10 Cir., 1975)

DEFENDANT's position would be strengthened in following situations:

SUPPOSE:

Plaintiff disclosed its product information in negotiations with defendant.

Plaintiff disclosed its product information to outsiders.

Cf. Crown Industries Inc. V. Kawneer Co.

335 F. Supp. 749 (N.D. Ill., 1971)

Plaintiff disclosed its product information to outsiders.

Cf. Midland-Ross Corp. V. Yokana

293 F. 2d 411 (3 Cir. 1961)

Plaintiff disclosed its product information in negotiations with defendant.

Plaintiff's product information was about customer business relations.

Cf. Automated-Systems V. Service-Bureau

401 F.2d 619 (10 Cir., 1968)

Plaintiff disclosed its product information to outsiders.

Cf. Midland-Ross Corp. V. Sunbeam Equipment Corp.

316 F. Supp 171 (W.D. Pa., 1970)

5.4 The *USM* Example

HYPO's analysis of the *USM* case is presented here in abbreviated form. The contents of this section are as follow:

1. A squib summary for the case is presented in Section 5.4.1.
2. Section 5.4.2 shows the claim-lattice for a trade secrets misappropriation claim.
3. Section 5.4.3 shows HYPO's output summary, arguments and suggested hypotheticals.

Chapters 6 through 8 treat the *USM* case in detail as an example illustrating HYPO's representation scheme and reasoning process. The legal-case-frames are described in Chapter 6. Chapter 7 presents the interpretation-frame and case-analysis-record. The process of interpreting the claim-lattice and selecting the best cases is discussed in Chapter 8. Chapter 10 compares HYPO's arguments in the *USM* case to those actually made in the counsels' briefs and the court's opinion.

5.4.1 The Squib for the *USM* Case

Title: *USM Corp. v. Marson Fastener Corp.*

Cite: 379 Mass. 90 (Supreme Judicial Court)

Date: August 29, 1979

Parties: Π: USM Corp.; Δ: Marson

Claim: Trade Secrets Misappropriation

Procedural Setting: Π appeals from judgement affirming master's report and dismissing complaint.

Decision: For Π reversing dismissal.

Facts:

From 1954 to 1959, USM began to develop a machine ("USM machine") to produce blind rivets (i.e., fasteners insertable from only one end of the material to be fastened.) The information associated with the developing the machine was not generally known. Marson hired a USM employee, F. Lahnston to construct a similar machine using blueprints of the USM machine supplied by Marson. USM took the following steps to protect the information: (1) employees were required to sign nondisclosure agreements; (2) excluded general public from production areas. However, USM: (a) did not stamp drawings "confidential"; (b) did not direct employees that drawings were secret; (c) allowed escorted tours by distributors, including defendants. The secrets were not easily discernable by inspection of the machine. Master found that defendant's acquisition of blueprints was improper.

Issues: Did USM Corp. take sufficient reasonable steps to preserve the secrecy of the information embodied in the USM machine?

Holding: Yes, for Π: "We do not require the possessor of a trade secret to take heroic measures to preserve its secrecy."

Cases cited: *Eastern Marble Prods. Corp. v. Roman Marble, Inc.*, 372 Mass. 835 (1977); Distinguished *J.T. Healy & Son v. James A. Murphy & Son*, 357 Mass. 728 (1970).

5.4.2 Positioning *USM*

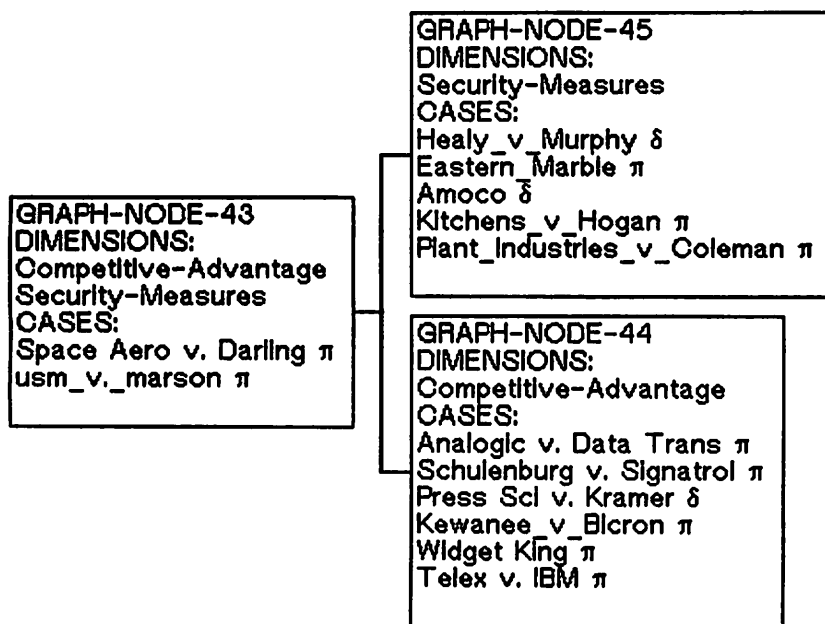

Figure 17: Claim-Lattice for Trade Secrets Claim in *USM* Example

5.4.3 Argument Outputs for *USM*

Citation Summary:

3-Ply Arguments for Best Cases to Cite
on Claim of TRADE-SECRETS-MISAPPROPRIATION
in Fact Situation of *Usm-V.-Marson*:

On a claim for TRADE-SECRETS-MISAPPROPRIATION,
PLAINTIFF can make a stronger argument.
PLAINTIFF can cite the following cases
for which there are
no more on point counter-examples:

Space Aero Products Co. V. R.E. Darling Co.
208 A.2d 74 (Ct.App., Md., 1965)

Peggy Lawton Kitchens, Inc. V. Hogan
466 N.E.2d 138 (Mass. App. 1984)

Plant Industries, Inc. V. Coleman
287 F.Supp. 636 (C.D.Cal., 1968)

3-Ply Arguments in *USM*:

[1]

==> POINT for PLAINTIFF as Side-1:

WHERE:

Defendant's access to plaintiff's product information saved it time or expense.

PLAINTIFF should win a claim for TRADE-SECRETS-MISAPPROPRIATION.

CITE: Telex Corp. V. Ibm Corp. (1)
510 F.2d 894 (10 Cir., 1975).

<== RESPONSE for DEFENDANT as Side-2:

Telex Corp. V. Ibm Corp. (1) is distinguishable because:

In Telex V. Ibm, defendant's access to plaintiff's product information saved it more time or expense than in *Usm-V.-Marson*In Telex V. Ibm, plaintiff and defendant entered into a nondisclosure agreement. Not so in *Usm-V.-Marson*.In Telex V. Ibm, Defendant paid plaintiff's former employee to switch employment. Not so in *Usm-V.-Marson*.**COUNTER-EXAMPLES:**Pressure Science, Inc. V. Kramer
413 F.Supp. 618 (D. Conn., 1976), is as on point and held for DEFENDANT.

==> REBUTTAL for PLAINTIFF as Side-1:

Pressure Science, Inc. V. Kramer is distinguishable because:

In *Usm-V.-Marson*, plaintiff adopted more security measures than in *Press Sci V. Kramer*.

[2]

==> POINT for PLAINTIFF as Side-1:

WHERE:

Defendant's access to plaintiff's product information saved it time or expense.

PLAINTIFF should win a claim for TRADE-SECRETS-MISAPPROPRIATION.

CITE: Kewanee Oil Co. V. Bicron Corp.
416 U.S. 470, 94 S.Ct. 1879, 40 L.Ed.2d 315 (1974).

<== RESPONSE for DEFENDANT as Side-2:

Kewanee Oil Co. V. Bicron Corp. is distinguishable because:

In Kewanee-V-Bicron, defendant's access to plaintiff's product information saved it more time or expense than in Usm-V.-Marson

In Kewanee-V-Bicron, plaintiff and defendant entered into a nondisclosure agreement. Not so in Usm-V.-Marson.

In Kewanee-V-Bicron, defendant received something of value for entering into the agreement. Not so in Usm-V.-Marson.

COUNTER-EXAMPLES:

Pressure Science, Inc. V. Kramer
413 F.Supp. 618 (D. Conn., 1976), is as on point and held for DEFENDANT.

==> REBUTTAL for PLAINTIFF as Side-1:

Pressure Science, Inc. V. Kramer is distinguishable because:

In Usm-V.-Marson, plaintiff adopted more security measures than in Press Sci V. Kramer.

[3]

==> POINT for PLAINTIFF as Side-1:

WHERE:

Defendant's access to plaintiff's product information saved it time or expense.

PLAINTIFF should win a claim for TRADE-SECRETS-MISAPPROPRIATION.

CITE: Analogic Corp. V. Data Translation, Inc.
358 N.E.2d 804 (S.J.C., Mass., 1976).

<== RESPONSE for DEFENDANT as Side-2:

Analogic Corp. V. Data Translation, Inc. is distinguishable because:

In Analogic V. Data Trans, defendant's access to plaintiff's product information saved it more time or expense than in Usm-V.-Marson

In Analogic V. Data Trans, plaintiff and defendant entered into a nondisclosure agreement. Not so in Usm-V.-Marson.

In Analogic V. Data Trans, plaintiff's former employee brought product development information to Defendant. Not so in Usm-V.-Marson.

COUNTER-EXAMPLES:

Pressure Science, Inc. V. Kramer

413 F.Supp. 618 (D. Conn., 1976), is as on point and held for DEFENDANT.

==> REBUTTAL for PLAINTIFF as Side-1:

Pressure Science, Inc. V. Kramer is distinguishable because:

In Usm-V.-Marson, plaintiff adopted more security measures than in Press Sci V. Kramer.

[4]

==> POINT for PLAINTIFF as Side-1:

WHERE:

Plaintiff adopted security measures.

PLAINTIFF should win a claim for TRADE-SECRETS-MISAPPROPRIATION.

CITE: Plant Industries, Inc. V. Coleman
287 F.Supp. 636 (C.D.Cal., 1968).

<== RESPONSE for DEFENDANT as Side-2:
None.

==> REBUTTAL for PLAINTIFF as Side-1:
None.

[5]

==> POINT for PLAINTIFF as Side-1:

WHERE:

Plaintiff adopted security measures.

PLAINTIFF should win a claim for TRADE-SECRETS-MISAPPROPRIATION.

CITE: Peggy Lawton Kitchens, Inc. V. Hogan
466 N.E.2d 138 (Mass. App. 1984).

<== RESPONSE for DEFENDANT as Side-2:
None.

==> REBUTTAL for PLAINTIFF as Side-1:
None.

[6]

==> POINT for PLAINTIFF as Side-1:

WHERE:

Plaintiff adopted security measures.

PLAINTIFF should win a claim for TRADE-SECRETS-MISAPPROPRIATION.

CITE: Eastern Marble Products Corp. V. Roman Marble, Inc.
364 N.E.2d 799 (Mass. 1977).

<== RESPONSE for DEFENDANT as Side-2:

Eastern Marble Products Corp. V. Roman Marble, Inc. is distinguishable because:

In Eastern-Marble, plaintiff and defendant entered into a nondisclosure agreement. Not so in Usm-V.-Marson.

COUNTER-EXAMPLES:

Healy, Inc. V. Murphy, Inc.
357 Mass. 728 (1970), is as on point and held for DEFENDANT.

==> REBUTTAL for PLAINTIFF as Side-1:

Healy, Inc. V. Murphy, Inc. is distinguishable because:

In Usm-V.-Marson, plaintiff adopted more security measures than in Healy-V-Murphy

In Usm-V.-Marson, defendant's access to plaintiff's product information saved it more time or expense than in Healy-V-Murphy.

[7]

==> POINT for PLAINTIFF as Side-1:

WHERE:

Plaintiff adopted security measures.

Defendant's access to plaintiff's product information saved it time or expense.

PLAINTIFF should win a claim for TRADE-SECRETS-MISAPPROPRIATION.

CITE: Space Aero Products Co. V. R.E. Darling Co.

208 A.2d 74 (Ct.App., Md., 1965).

<== RESPONSE for DEFENDANT as Side-2:

Space Aero Products Co. V. R.E. Darling Co. is distinguishable because:

In Space Aero V. Darling, Defendant paid plaintiff's former employee to switch employment. Not so in Usm-V.-Marson.

In Space Aero V. Darling, plaintiff's former employee brought product development information to Defendant. Not so in Usin-V.-Marson.

==> REBUTTAL for PLAINTIFF as Side-1:

None.

3-Ply Argument in USM for Case Selected by Attorney:

3-Ply Argument for Selected Case to Cite
on Claim of TRADE-SECRETS-MISAPPROPRIATION
in Fact Situation of Usm-V.-Marson:

[8]

==> POINT for DEFENDANT as Side-1:

WHERE:

EVEN THOUGH:

Plaintiff adopted security measures.

DEFENDANT should win a claim for TRADE-SECRETS-MISAPPROPRIATION.

CITE: Healy, Inc. V. Murphy, Inc.
357 Mass. 728 (1970).

<== RESPONSE for PLAINTIFF as Side-2:

Healy, Inc. V. Murphy, Inc. is distinguishable because:

In Usm-V.-Marson, plaintiff adopted more security measures than in Healy-V-Murphy

In Usm-V.-Marson, defendant's access to plaintiff's product information saved it more time or expense than in Healy-V-Murphy.

COUNTER-EXAMPLES:

Plant Industries, Inc. V. Coleman

287 F.Supp. 636 (C.D.Cal., 1968), is as on point and held for PLAINTIFF.

Peggy Lawton Kitchens, Inc. V. Hogan

466 N.E.2d 138 (Mass. App. 1984), is as on point and held for PLAINTIFF.

Space Aero Products Co. V. R.E. Darling Co.

208 A.2d 74 (Ct.App., Md., 1965), is more on point and held for PLAINTIFF where it was also the case that:

Defendant's access to plaintiff's product information saved it time or expense.

**3-Ply Argument for *Eastern Marble Case*, Selected
by Attorney on Subsequent Loop through Basic Processing Loop**

[9]

==> POINT for PLAINTIFF as Side-1:

WHERE:

Plaintiff and defendant entered into a nondisclosure agreement.

PLAINTIFF should win a claim for **TRADE-SECRETS-MISAPPROPRIATION**.

CITE: Structural Dynamics Research Corp. V. Engineering Mechanics Research Corp.

401 F. Supp. 1102 (E.D.Mich., 1975).

<== **RESPONSE** for **DEFENDANT** as Side-2:

Structural Dynamics Research Corp. V. Engineering Mechanics Research Corp.
is distinguishable because:

In Structural Dynamics, defendant received something of value for entering into the agreement. Not so in Eastern-Marble.

In Structural Dynamics, plaintiff's former employee brought product development information to Defendant. Not so in Eastern-Marble.

In Structural Dynamics, the nondisclosure agreement specifically referred to plaintiff's product. Not so in Eastern-Marble.

COUNTER-EXAMPLES:

Motorola, Inc. V. Fairchild Camera And Instrument Corp.

366 F.Supp. 1173 (D. Arizona, 1973), is as on point and held for **DEFENDANT**.

Amoco Production Co. V. Lindley

609 P.2d 733, is more on point and held for **DEFENDANT**

where it was also the case that:

Plaintiff adopted security measures.

==> **REBUTTAL** for **PLAINTIFF** as Side-1:

Motorola, Inc. V. Fairchild Camera And Instrument Corp. is distinguishable because:

In Eastern-Marble, plaintiff adopted more security measures than in Motorola.

Suggested Hypotheticals in *USM*:

Hypotheticals to Consider
on Claim of TRADE-SECRETS-MISAPPROPRIATION
in Fact Situation of *Usm-V.-Marson*:

DEFENDANT's position would be strengthened in following situations:

SUPPOSE:

Plaintiff disclosed its product information in negotiations with defendant.
Plaintiff disclosed its product information to outsiders.
Cf. *Crown Industries Inc. V. Kawneer Co.*
335 F. Supp. 749 (N.D. Ill., 1971)

Plaintiff disclosed its product information in negotiations with defendant.
Cf. *Speedry Chemical Products, Inc. V. Carter's Ink Company*
306 F.2d 328 (2d Cir., 1962)

Plaintiff disclosed its product information in negotiations with defendant.
Plaintiff's product information was about customer business relations.
Cf. *Automated-Systems V. Service-Bureau*
401 F.2d 619 (10 Cir., 1968)

CHAPTER 6

The Case Knowledge Base

HYPO's arsenal of cases for making legal arguments is its Case Knowledge Base. The cases in the CKB are represented and organized to make retrieval of relevant cases as straight-forward a task as possible. This chapter describes the content and organization of HYPO's Case Knowledge Base. It focuses on:

1. Legal-Case-Frames, the first tier of HYPO's case representation language in which all of the cases in the CKB are represented.
2. Three major routes for accessing relevant cases in the CKB, including the most important route, the Dimensional Index.

6.1 Legal-Case-Frames

As described in Chapter 4, legal-case-frames are used to represent all legal disputes in HYPO, including:

1. Actual legal cases in HYPO's Case Knowledge Base;
2. Current fact situations presented by the attorney to HYPO through the CASE EDITOR; and

3. Hypothetical cases generated by the HYPO-GENERATOR.

Legal-case-frames summarize much of the same information about a legal case that lawyers or law students record in squib summaries. A squib, or case brief, is a schematic summary of the important facts and legal conclusions of a case as set forth in the opinion of the Court.¹ Law students make squibs to help them remember cases to cite in examinations and oral arguments in class. Similarly, legal-case-frames are a schematic summary of a case that record enough information about a case to enable the 3-PLY ARGUER to cite them in arguments. Like squibs, legal-case-frames record the following information about a case.

1. Title (e.g., *USM Corp. v. Marson Fastener Corp.*)
2. Citation to the case including the location of the published opinion, what court decided the case and the date of the decision.
3. Parties, including identifying who the plaintiffs and defendants are.
4. Legal claims asserted by the plaintiff (e.g., trade secrets misappropriation or breach of contract.)
5. Winner of the decision on each claim, either plaintiff or defendant.
6. Legal issues specifically addressed by the court in making its decision and the court's holding on those issues.
7. Important cases cited, distinguished, or overturned by the court.
8. Selected facts of the case.

As mentioned in Chapter 4, each legal case represented in HYPO has:

¹See Chapter 5 for examples of squib summaries for the *Crown*, *Structural Dynamics* and *USM* cases.

1. A top-level legal-case-frame called the CASE frame; and
2. Underlying legal-case-frames.

6.1.1 Top-Level Legal-Case-Frame

The top-level legal-case-frame represents the citation information, claims, court's decision of the claims and the issues and holdings. In other words, the CASE frame contains all of the information about a legal case enumerated above except the selected facts of the case. Figure 18 shows the top-level case-frame for the *USM Corp.* case.²

The top-level legal-case-frame summarizes the issues decided by the court in the case by recording:

1. What claims were involved in the case;
2. What factual features the court considered important in connection with each claim;
3. Which side won the claim, plaintiff or defendant.

The important factual features are represented by dimensions. As described in Chapter 4, dimensions represent the important strengths and weaknesses of a plaintiff's claim. The association of factual features with claims and winners is accomplished in three slots of the top-level frame:

1. **Claims-Held-For:** lists the claims involved in the case and which side won the claim;

²The squib summary of the case may be found in Section 5.4.1.

2. **Dimensions-List:** lists all of the dimensions that apply to the case;
3. **Claim-Dimensions-Alist:** an association list for associating the applicable dimensions with the particular claims to which they were relevant according to the court.

Thus, in Figure 18, the contents of the claims-held-for, dimensions-list and claim-dimensions-alist slots indicate that in the *USM Corp.* case the court held for the plaintiff (USM) on a claim for trade secrets misappropriation because of, or in spite of, factual features that are associated with the case's position along the *Competitive-Advantage-Gained* and *Security-Measures-Adopted* dimensions.

The dimensions recorded in the dimensions-list of the top-level legal-case-frame were put there by the CASE EDITOR when the case was first entered into the CKB. As part of the case entry process, the CASE-ANALYZER performed a dimensional analysis of the facts of the case as represented by the underlying legal-case-frames. The results of that analysis, namely which dimensions applied to the case, were recorded at that time in the top-level legal-case-frame.

6.1.2 Underlying Legal-Case-Frames

Underlying legal-case-frames are used to represent the facts of the case. As discussed in Chapter 4, there are nested frames to represent the important objects, participants and selected relationships in the case. A complete listing of types of legal-case-frames may be found in Appendix F.

For example, Figures 19 through 22 show the underlying legal-case-frames for representing the facts of the *USM* case. Figure 19 shows the legal-case-frames for the parties in the case (CORPORATE-PARTY). There are two corporate parties, the plaintiff, USM Corp. and defendant, Marson. Their respective products (PRODUCT) are shown in Figures 20 and 22. Note that the products

compete with one another (See competitors-product-alist) and that the project-development-time slots of the two products contain enough information for comparing how much time the defendant Marson saved in coming up with its competing product. (This information is the focal slot of the *Competitive-Advantage-Gained* dimension. The fact that a defendant saved development time and expense has been cited in other cases as a strength of the plaintiff's position in a trade secrets misappropriation claim.) The security-measures-list of plaintiff's product shows steps that USM Corp. took to protect security relative to the product and the information (KNOWLEDGE) used to develop it, namely "about-usm-machine" which is shown in Figure 21. Note that each case-frame has a case slot containing a pointer to the top-level legal case frame.

Detailed examples of the legal-case-frames for other cases are set out in Chapter 5. The *Crown* case involved plaintiff's disclosures to outsiders and a specific disclosure to the defendant in negotiations. The case-frames, including a DISCLOSURE-EVENT, are shown in Section 5.1.2. The *Amexco* fact situation, Section 5.2.1, which involved a former employee bringing secrets he developed himself to a competing employer, shows the particular case-frames for representing nondisclosure agreements (NONDISCLOSURE-AGREEMENT) and employment relations (EMPLOYEE, EMPLOYMENT, and EMPLOYMENT-CHANGE).

The slots of the legal-case-frames are filled in one of two ways. When an attorney enters a current fact situation or a new case into the CKB, he fills in the slots with the aid of the CASE EDITOR. When HYPO generates a hypothetical case, the HYPO-GENERATOR fills in the values of the underlying legal-case-frames. Once the underlying legal-case-frames have been filled in, the CASE-ANALYZER can analyse the fact situation to determine what factual predicates are satisfied by and what dimensions apply to the fact situation. In the *USM* case, the initial case analysis showed that two dimensions applied:

1. *Security-Measures-Adopted*, by virtue, in part, of the information in the plaintiff's PRODUCT concerning security measures; and
2. *Competitive-Advantage-Gained*, by virtue, in part, of the information in the plaintiff's and defendant's PRODUCTS concerning development time saved.

As mentioned above, the results of the case analysis were stored in the CASE frame's dimension list when the *USM* case was entered into the CKB.

6.2 Organization of the CKB

The Case Knowledge Base consists of 30 legal cases. Appendix G shows a complete listing of all of the cases in the CKB. Each case is represented in the legal-case-frame language with a completely filled in top-level legal-case-frame and as many underlying legal-case-frames as are necessary to represent the facts of the case. The CKB is a list of pointers to the CASE frames of all the cases. It is one of the typed lists of the *global-catalog*. The *global-catalog* contains an association list of pointers to all the legal-case-frames of all of the cases broken down by type. For example, there is a typed-list for CASE frames, PRODUCTS, KNOWLEDGE, and for each of the other case-frame types.

There are three routes for accessing relevant cases in the Case Knowledge Base:

1. Dimensional Index;
2. Global Catalog typed lists;
3. Cross-references in cases.

The main route for accessing cases in the CKB is the **Dimensional Index** in which all cases in the CKB are indexed by the important factual features relevant to a particular claim as represented by the dimensions that apply to the case. Chapter 7 describes the kind of reasoning that can be performed in the dimensional index.

When searching for a case in the CKB to which a particular dimension applies, it is not necessary for each case to be analyzed to determine which dimensions apply. That was done when the case was first entered into the CKB and the results are recorded in the dimensions-list of each top-level legal-case-frame. As discussed in Section 4, when the CASE POSITIONER retrieves all of the cases in the CKB to which a particular dimension applies, the program searches the typed list of top-level legal-case-frames in the *global-catalog* for any CASE frame whose dimensions-list contains a pointer to the dimension.

The second route for accessing relevant cases in the CKB is via the typed-lists of the *global-catalog*. All cases in the CKB that have a particular fact can be retrieved by searching the appropriate typed-list. As previously mentioned, all of the legal-case-frames are catalogued in the *global-catalog* according to their types (e.g., CASE, CORPORATE-PARTY, INFORMATION, etc.) Each legal-case-frame has a pointer to the top-level legal-case-frame. Here are a few examples of the kinds of queries that this access route handles:

- All cases in the CKB that involve trade secrets claims are retrieved by searching the typed-list of CASE frames for those whose claims-held-for list contain that claim.
- All cases involving a common employee are retrieved by searching the typed-list for EMPLOYMENT-CHANGES.
- All cases involving computer-related products are retrieved by searching the PRODUCTS typed-list for products with appropriate values in the a-kind-

of slot.

- Similarly, inquiries about the facts of a particular case are handled by searching the appropriate typed list in the *global-catalogue* for the legal-case-frame associated with that case that includes the desired information.

The third route for accessing relevant cases in the CKB is by following cross pointers from a given case to other cases cited or distinguished in the opinion of the case. This represents an alternative means of accessing relevant cases once an appropriate case has been found. As indicated above, each CASE frame contains a cases-cited slot with references to major cases cited in the opinion of a case, some of which are in HYPO's CKB.

A given case in the CKB is linked to other cases in two ways: by dimensions and express cross references. For instance, the Dimensional Index links the *USM* case to each other case in the CKB indexed by either of the two dimensions of its dimensions-list:

- *Security-Measures-Adopted* links it to the *Healy, Eastern Marble, Amoco, Kitchens, Plant Industries, and Space Aero* cases.
- *Competitive-Advantage-Gained* links it to the *Analogic, Schulenburg, Pressure Science, Kewanee, Widget King, Telex* cases and *Space Aero* cases.

USM may also be accessed from any case, like the *Eastern Marble* case that cites it in its opinion as reflected in the cases-cited slot of the CASE frame. In addition, the *USM* case is retrievable based on searches through the *global-catalog* typed lists, for example, for all trade secrets misappropriation cases that do not involve nondisclosure agreements.

6.3 Figures

```

(make-instance
 'CASE
 :NAME "usm corp. v. marson fastener corp."
 :SHORT-TITLE "usm-v.-marson"
 :CITATION "379 Mass. 90"
 :DATE "August 29, 1979"
 :PARTY-LIST '(USM MARSON)
 :ROLE-PARTY-ALIST '((PLAINTIFF USM) (DEFENDANT MARSON))
 :DECISION-FOR '(USM)
 :CLAIMS-HELD-FOR '((TRADE-SECRETS-MISAPPROPRIATION USM))
 :DIMENSIONS-LIST
 '(COMPETITIVE-ADVANTAGE-GAINED
 SECURITY-MEASURES-ADOPTED)
 :CLAIM-DIMENSIONS-ALIST
 '((TRADE-SECRETS-MISAPPROPRIATION
 COMPETITIVE-ADVANTAGE-GAINED
 SECURITY-MEASURES-ADOPTED))
 :CASES-CITED
 '(:RELIED "eastern marble v. roman marble"
 (:DISTINGUISHED "healy v. murphy"))) )

```

Figure 18: Top Level Case Frame for *USM Corp. v. Marson*

```
(make-instance
  'CORPORATE-PARTY
  :NAME 'USM
  :CASE-ROLE '(PLAINTIFF)
  :CASE 'usm corp. v. marson fastener corp.
  :EMPLOYEE-LIST NIL
  :COMPETITOR-PRODUCT-ALIST '((MARSON MARSON-MACHINE))
  :PRODUCT-LIST '(USM-MACHINE)
)
```

```
(make-instance
  'CORPORATE-PARTY
  :NAME 'MARSON
  :CASE-ROLE '(DEFENDANT)
  :CASE 'usm corp. v. marson fastener corp.
  :EMPLOYEE-LIST NIL
  :COMPETITOR-PRODUCT-ALIST '((USM USM-MACHINE))
  :PRODUCT-LIST '(MARSON-MACHINE)
)
```

Figure 19: Case Frames for Parties in *USM Corp.*

```

(make-instance
  'PRODUCT
  :NAME 'USM-MACHINE
  :CASE 'usm corp. v. marson fastener corp.
  :A-KIND-OF '(BLIND-RIVET-MACHINE)
  :PRODUCT-USED-FOR '("rivet manufacture")
  :GENERAL-PRODUCT-MARKET '(RIVET-BUYERS)
  :TECHNOLOGY-USED '(RIVET-DESIGN RIVET-MANUFACTURE
MARKET-ANALYSIS)
  :COMPARISON-W-GENERALLY-AVAILABLE-COMPETITIVE-
PRODUCTS NIL
  :COMPETITORS-PRODUCT-ALIST '((MARSON MARSON-MACHINE))
  :DEVELOPER '(USM)
  :CUSTOMER-LIST NIL
  :EMPLOYMENT-WORKED-ON-PROJECT-LIST NIL
  :PROJECT-DEVELOPMENT-START '(1954)
  :PROJECT-DEVELOPMENT-END '(1959)
  :PROJECT-DEVELOPMENT-TIME '(60)
  :EXPENDITURES-MADE nil
  :KNOWLEDGE-USED '(ABOUT-USM-MACHINE)
  :SECURITY-MEASURES-LIST
  '(*minimal-measures*
    *access-to-premises-controlled*
    *restrictions-on-entry-by-visitors*
    *employee-nondisclosure-agreements*)
  :SECURITY-BREACH-LIST NIL
  :EX-INTRINSIC-SIMILARITIES-WITH-COMPETITIVE-PRODUCT NIL
)

```

Figure 20: Case Frame for Π 's Product in *USM*

```

(make-instance
 'KNOWLEDGE
 :NAME 'about-usm-machine
 :CASE 'usm corp. v. marson fastener corp.
 :KNOWLEDGE-ABOUT '(usm-machine)
 :KIND-OF-KNOWLEDGE '(technical)
 :PARTY-WITH-ACCESS-LIST NIL
 :OTHER-PERSON-WITH-ACCESS-LIST NIL
 :SPECIFIC-DISCLOSURE-EVENTS NIL
 :NUMBER-PERSONS-WITH-ACCESS NIL
 :NUMBER-DISCLOSEES NIL
 :PERCENT-DISCLOSEES-RESTRICTED NIL
 :DISCLOSURE-RESTRICTION NIL
 :GENERALLY-KNOWN-IN-INDUSTRY NIL
 )

```

Figure 21: Case Frame for Π 's Knowledge in *USM*

```

(make-instance
 'PRODUCT
 :NAME 'marson-machine
 :CASE 'usm corp. v. marson fastener corp.
 :A-KIND-OF '(blind-rivet-machine)
 :PRODUCT-USED-FOR '(“rivet-manufacture”)
 :GENERAL-PRODUCT-MARKET '(rivet-buyers)
 :TECHNOLOGY-USED '(rivet-design rivet-manufacture market-analysis)
 :COMPARISON-W-GENERALLY-AVAILABLE-COMPETITIVE-
 PRODUCTS NIL
 :COMPETITORS-PRODUCT-ALIST '((usm usm-machine))
 :DEVELOPER '(marson)
 :PROJECT-DEVELOPMENT-START '(1961.)
 :PROJECT-DEVELOPMENT-END '(1964.)
 :PROJECT-DEVELOPMENT-TIME '(36)
 :EXPENDITURES-MADE nil
 )

```

Figure 22: Case Frames for Δ 's Product in *USM*

CHAPTER 7

A Dimensional Index

Dimensions constitute the primary index for retrieving relevant cases from the Case Knowledge Base. They are also instrumental for comparing cases, selecting the most relevant cases, citing them in legal arguments, and modifying them hypothetically. In this chapter, we examine the definition, structure, and functions of dimensions in HYPO and describe the kind of reasoning that is performed in the Dimensional Index.

7.1 Dimensions Defined

Dimensions are axes for comparing cases. Specifically, a **dimension** is a knowledge structure that identifies a common feature of two or more cases involving a given legal claim in terms of which the strength or weakness of the plaintiffs' legal positions on the claim can be *compared*.

Dimensions capture the features of a case that are important for the decision of a claim. If a dimension applies to a fact situation, it means that the fact situation shares some feature in common with at least one case where a court decided the case because, or in spite, of the presence of that feature. Dimensions are not definitional elements of a claim – they do not purport to specify necessary and sufficient conditions for determining the existence of a claim. Rather, they

represent factors that make a claim in a given fact situation stronger or weaker. They encode knowledge of which features have relevance for arguing the legal merits of claim.

Since dimensions computationally define relevant similarities and differences among precedents, they are a natural choice for indexing precedents in the CKB. Relevant similarities and differences involve the features of a precedent because, or in spite, of which the court decided the precedent. Dimensions capture these features. If the precedent shares such a feature with a fact situation, that is a **relevant similarity** between the precedent and the fact situation. A **relevant difference** is:

1. A difference in the "magnitude" of a feature shared by the fact situation and the precedent;
2. The presence in the fact situation of additional, unshared features that makes the fact situation similar to other precedents; or
3. The presence in the precedent of additional, unshared features that makes the precedent similar to other precedents.

Note that dimensions focus on features whose legal significance can be justified by citing cases. For each dimension, there is at least one case where the court decided the case because or in spite of the feature associated with the dimension. That case can be cited in a legal argument that a similar fact situation should be decided in the same way.

HYPO has thirteen implemented dimensions. Appendix H shows a complete listing of implemented dimensions that apply in cases involving claims for trade secrets misappropriation, breach of noncompetition / nondisclosure agreements or breach of contract. For each dimension, the listing shows its short name, the

applicable claim, a generalized statement of the associated plaintiff's strength and focal slot and range information.

7.2 Structure and Mechanics of Dimensions

As mentioned in Chapter 4, each dimension is a frame with the following facets:

1. Prerequisites, expressed in terms of factual predicates, for determining whether a dimension applies to a fact situation or not;
2. Focal slots that single out the particular facts making a case stronger or weaker along the dimension;
3. Range information that tells how a change in the focal slot affects that strength. The range information includes the range of possible values of the focal slots and the direction in the range that strengthens the plaintiff's position along the dimension.

Each dimension represents a tack for arguing about a legal claim. *One* way to argue about a trade secret misappropriation claim is to consider whether the plaintiff let the "cat out of the bag" by disclosing its supposed secrets to outsiders. From this viewpoint, the more disclosees there are, the worse off the plaintiff is with respect to claiming that his putative secret was misappropriated. Information for comparing trade secrets cases from this viewpoint is contained in the *Secrets-Disclosed-Outsiders* dimension (See Figure 23). A *second* way to argue a trade secrets claim focuses on whether the plaintiff took adequate steps to protect its confidential information. The more kinds of precautions it took, the more it appears that the information was indeed a secret with commercial value. Cases can be compared in this regard using the information in the

Security-Measures dimension (See Figure 24). A *third* way of arguing checks how much of an unfair competitive advantage the defendant secured from its access to plaintiff's confidential information. The more development time and expense the defendant saved, the stronger the plaintiff's position on a trade secrets claim. The *Competitive-Advantage* dimension captures information for comparing cases along this line (See Figure 25).

7.2.1 Prerequisites

Each dimension has prerequisites, conditions necessary for the dimension to be said to apply to a case. If the dimension's prerequisites are satisfied, it makes sense to compare the case to others indexed by the dimension in terms of the factual strength associated with the dimension. As discussed in Chapter 4, the prerequisites are composed of factual predicates. Each dimension's prerequisites slot contains a list of factual predicates. For example, to paraphrase the prerequisites list of the *Security-Measures* dimension (Figure 24), it requires that:

There is a corporate plaintiff
who makes a product
about which there is product development information,
and a corporate defendant who makes a competing product.
There must be information about what security measures plaintiff
took for its product.

As defined in Chapter 4 factual predicates are the second-tier language for summarizing the facts of a case represented by the underlying legal-case-frames. They confirm whether legally significant relationships are true in the case. Appendix I lists all of the factual predicates and the values that they may take. Each factual predicate has an associated retrieval method, a function for deter-

mining whether the factual predicate is satisfied in the case or not. The CASE-ANALYZER determines in one operation all of the factual predicates that are satisfied by the case and stores the results in the interpretation frame, each of whose slots correspond to a factual predicate. Besides NIL or *negative*, the interpretation-frame's slots may have as a value T or a pointer to an underlying legal-case-frame or slot value from a legal-case-frame.

Although the list of prerequisites in a dimension may appear to be flat, there actually is an implicit order imposed by the order of filling out the interpretation frame. The firing of the retrieval methods by the CASE-ANALYZER is ordered to allow for the most efficient completion of the interpretation frame. The retrieval methods take as their arguments slot values from the interpretation frame. Only if the value of the appropriate interpretation frame slot is NIL (and no previous attempt to fill it has been made), does the retrieval method resort to searching the *global-catalog* for the required legal-case-frame objects.

For an example, consider Figure 26, which shows excerpts from a completed case-analysis-record for the *USM* case, and Figure 27, the completed INTERP-FRAME. Note that all of the factual predicates listed as prerequisites for the *Security-Measures* and for the *Competitive-Advantage* dimensions are satisfied and that the CASE-ANALYZER has duly listed those dimensions as applicable.¹ When the CASE-ANALYZER filled in the INTERP-FRAME slot for the factual predicate *exists-info-re-security-measures*, the corresponding retrieval method (:retrieve-exists-info-re-security-measures) was called. The method checked the security-measures-list of USM's PRODUCT² a pointer to which is the value of the INTERP-

¹In this example, we are treating the *USM* case as a current fact situation and running it through the basic processing loop. As we saw in Chapter 6, the *USM* case is also in the CKB indexed under the *Security-Measures* and *Competitive-Advantage* dimensions. Thus, the CASE-ANALYZER confirms that the case is properly indexed.

²See Figure 20

FRAME slot claimant-makes-product1,³ found a list of security measures (i.e., *minimal-measures*, *access-to-premises-controlled*, etc.) and filled in the INTERP-FRAME slot for exists-info-re-security-measures accordingly. Since that factual predicate and all of the other prerequisites of *Security-Measures* were satisfied, that dimension was added to the applicable-dimensions list of the case-analysis-record.

7.2.2 Comparing Cases Along a Dimension

Any two cases to which a dimension applies can be compared in terms of the relative values in each case of the dimension's focal-slots. As described in Chapter 4 this is what the 3-PLY-ARGUER does when it distinguishes a cited case from the current fact situation along a shared dimension. The ranges and pro-p-directions slots of each dimension contain information that help interpret the comparison. Associated with each range is information about the range's

- Comparison type.
- Possible values (and the appropriate units).
- Direction in the range that favors the plaintiff.

There are five comparison types:

- Some versus None
- More versus Less
- Relative Position in Ordered Set (i.e., Interval)
- Greater-than versus Less-than

³If that value had been NIL, the method would search the *global-catalog* typed-list of PRODU-UCTs for a USM product

- Computed

The comparison type specifies what kind of ordering scheme the range values represent and how to compare focal-slot values along that range. In other words, it defines the “greater-than” relation to be used for that range. “Some versus None” indicates that the comparison is binary (i.e., any non-NIL value being treated as greater than *negative*). “More versus Less” means that the more inclusive set of items from the possible values is treated as greater than its proper subset. For the “Interval” type, the range is treated as an ordered set. The leftmost item is the minimal item; the item to the right on the range of values is greater than an item. “Greater-than versus Less-than” indicates that the values are to be compared as numbers. “Computed” is an *ad hoc* type allowing for special kinds of comparisons. Each comparison type has an associated method for retrieving the focal slot values from each case to be compared. The focal slot specifies a “path name” consisting of a list of object and slot names that lead from the INTERP-FRAME to some slot value of an underlying legal-case-frame.

The pro-p-direction slot indicates whether being “greater-than” as defined by the comparison type favors the plaintiff or the defendant. For example, the pro-p-direction for the *Security-Measures* direction is “more”, the more security measures the better for plaintiff. Similarly, the greater defendant’s savings of time and money, the better for plaintiff on the *Competitive-Advantage* dimension.

For examples of comparing cases, consider comparing the *USM* case to other cases along shared dimensions. In Chapter 6, we saw that the *Security-Measures* dimension links the *USM* case to six other cases in the CKB including the *Healy* case. The focal slot values for comparison are the respective values in each case of the exists-info-re-security-measures slot of the INTERP-FRAMES. In *Healy*, only *minimal-measures* were taken to protect plaintiff’s secret. The 3-PLY ARGUER actually performed this comparison in responding to the citation of the *Healy* case on behalf of the defendant in the *USM* example argument [8],

Section 5.4.3. The defendants distinction taken from the argument-record corresponding to argument [8] shows the result:

(:STRONGER

<CASE : usm corp. v. marson fastener corp.>

<CASE : Healy, Inc. v. Murphy, Inc. >

<DIMENSION : SECURITY-MEASURES-ADOPTED>

MORE

(*MINIMAL-MEASURES*

ACCESS-TO-PREMISES-CONTROLLED

RESTRICTIONS-ON-ENTRY-BY-VISITORS

EMPLOYEE-NONDISCLOSURE-AGREEMENTS)

(*MINIMAL-MEASURES*))

In other words, the *USM* case was found to be stronger than the *Healy* case along the *Security-Measures* dimension because plaintiff took more security measures in the former.

The *USM* case can also be compared to any of the seven cases indexed by the *Competitive-Advantage-Gained* dimension. This dimension has "computed" type ranges. The comparison involves taking the difference of the respective product-development-times and expenditures-made. A difference favoring plaintiff on both counts is treated as greater than a difference on only one count. In Argument [1] of the *USM* example, Section 5.4.3, the 3-PLY-ARGUER compared the *USM* case to the *Telex* case along this dimension in the process of distinguishing the latter. The result taken from the corresponding argument-record is:

(:WEAKER

<CASE : usm corp. v. marson fastener corp.>

<CASE : telex corp. v. ibm corp. (1)>
 <DIMENSION : COMPETITIVE-ADVANTAGE-GAINED>
 LESS
 (NIL (60 36))
 ((1000000 250000) (60 24)))

In other words, the *USM* case is weaker than *Telex* because there was evidence as to a savings only of development time, not both time and money.⁴

7.2.3 Near-miss Dimensions

A dimension is a near-miss with respect to a case if all of its prerequisites are satisfied in a case except certain triggering prerequisites. A dimension's focal-slot-prerequisites are its main set of triggering prerequisites. The focal-slot-prerequisites, the factual predicates associated with the dimension's focal slots, contain the crucial information that places a case somewhere along the range of the dimension. If the focal-slot-prerequisite is the only one missing, then the case is semantically close to other cases indexed by the dimension, thus distinguishing the dimension from other inapplicable dimensions. As described in Chapter 4, the CASE-POSITIONER uses near-miss dimensions in constructing extended claimlattices for positioning the current fact situation with respect to cases that would be legally significant if only the missing triggering prerequisites were present.

For example, the *Secrets-Disclosed-Outsiders* dimension is a near-miss with respect to the *USM* case. Note from the INTERP-FRAME of Figure 9 that the

⁴An earlier version of the *Competitive-Advantage* dimension compared the amounts of time or money saved. See [Rissland *et al.*, 1984]. Both kinds of comparisons are valid for distinguishing. Although, the numeric comparison has not yet been integrated into the current version of the dimension, the modification method associated with the *Competitive-Advantage* dimension does increase or decrease the amounts of time and money saved.

focal-slot-prerequisite, exists-disclosures-info1, is NIL. All other prerequisites of the dimension are satisfied. If there were information about whether the plaintiff USM Corp. disclosed its information to outsiders, then the cases indexed by the dimension, like the *Crown* case, would become more relevant.

By specifying focal-slot-prerequisites as triggers, we adopt a semantic as opposed to a syntactic definition of near-miss. It would, of course, be possible to define a near-miss syntactically. For example, a syntactic near-miss might be defined as a dimension all but one of whose prerequisites is satisfied with no restriction on what the missing prerequisite could be. The factual predicates are not of uniform graininess, however. The focal-slot-prerequisites focus on details relative to the other predicates in the prerequisites list which establish broader relationships in the case, like whether there is a defendant with a competing product (corps-1-2-compete-re-products-1-2) or whether the defendant had access to plaintiff's product information through plaintiff's former employee (corp2-access-product1-via-employee1). The focal-slot-prerequisites tend to focus on missing details that are significant but only if the broader relationships are present in the case. Though more restrictive than a syntactically defined near-miss, the semantic definition conveys greater assurance that the missing fact will be significant to the legal argument.

The best of both worlds is to begin the process of fact-gathering with a syntactic definition of near-miss (even broader than the one suggested above – for example, where the number of missing prerequisites may be greater than one) and to switch to more restrictive semantic definitions of near-misses as the broad structure of the case becomes clear. Alternatively, the factual prerequisites could be given a more explicit structure to guide the initial fact gathering process. Obtaining the right measure of flexibility is the problem. The program should not prevent the attorney from getting down to details as quickly as he or she likes. In the COUNSELOR project we have experimented with alternative means of

solving this problem in a system that coupled HYPO with a natural language understander and generator.

7.2.4 Citing Cases

Dimensions are used to determine if a case is "citable in the first instance" for a party in an argument, that is, whether the case is a good one to cite in a point for the side, or whether it should be reserved as a counter-example to cite only if needed to respond to an opponent's point. For example, the fact that plaintiffs in both the *USM* and *Eastern Marble* cases took some measures to protect security justifies citing the latter case in favor of USM Corp.'s trade secrets misappropriation. That is just what plaintiffs are supposed to do to keep their secrets confidential. By contrast, the fact that plaintiffs in both the *Crown* and *Data General* cases disclosed their secrets to outsiders is *not* a justification for citing the latter case in favor of Crown's trade secrets misappropriation, at least not in the first instance. Giving away their trade secrets is *not* what plaintiff's are supposed to do, although it is not always fatal to a plaintiff's claim. That is the significance of the *Data General* case. It is a good case for a plaintiff to cite as a counter-example to the proposition that a plaintiff who discloses its secrets should lose a trade secrets misappropriation claim.

Dimensions allow HYPO to make the distinction between good cases to cite in the first instance and cases better cited only as counter-examples. The dimensions are broken down into two groups in the *party-dimension-alist*:

1. Pro-Plaintiff Dimensions:

Agreement-Supported-By-Consideration

Common-Employee-Paid-To-Change-Employers

Exists-Express-Noncompetition-Agreement
Common-Employee-Transferred-Product-Tools
Disclosures-Subject-To-Restriction
Competitive-Advantage-Gained
Security-Measures-Adopted
Nondisclosure-Agreement-Re-Defendant-Access
Nondisclosure-Agreement-Specific

2. Pro-Defendant Dimensions:

Vertical-Knowledge
Secrets-Voluntarily-Disclosed
Disclosure-In-Negotiations-With-Defendant
Common-Employee-Sole-Developer

Dimensions from the first group represent pro-plaintiff strengths. Those in the second group represent plaintiffs' weaknesses. For example, the fact that *Security-Measures-Adopted* from group 1 applies to the *USM* case means that a pro-plaintiff case also indexed by the dimension can be cited in the first instance on behalf of the plaintiff. The 3-PLY-ARGUER made such a determination when it cited the *Eastern Marble* for the plaintiff in Argument [6] of Section 5.4.3. By contrast, the fact that the *Crown* case shares the *Secrets-Voluntarily-Disclosed* dimension of group 2 with the *Data General* case (which held for the plaintiff) is not a reason for citing the latter case in favor of plaintiff, except as a counter-example. Thus in the arguments of Section 5.1.7, the *Data General* case is not cited in a point for the plaintiff in the original *Crown* case, but only in responses as a counter-example.

7.2.5 Comparing Cases' On-Pointness

As described in Chapter 4, dimensions also play a major role in comparing the extent to which cases are on point to a fact situation. The relative on pointness of cases (i.e., which makes a tighter analogy to the cfs) is judged computationally by comparing the sets of dimensions that each case shares with the current fact situation. Examples how the CASE-POSITIONER performs the comparison are shown in Chapter 8.

7.2.6 Modifying Cases

As described in Chapter 4, the dimensions also play a primary role in the HYPO-GENERATOR's task of hypothetically modifying cases. Dimensions have two basic modification methods to:

1. Make a near-miss dimension apply to a case;
2. Change the strength of a case along an applicable dimension (either making it extreme on the dimension or changing it relative to the position of an actual case).

Dimension modification methods are discussed below in Section 8.4.

7.3 Relations among Claims and Dimensions

Dimensions are a link between claims and ways to strengthen or weaken a claim in a specific fact situation. Figure 28 graphically illustrates this linkage. Each of the three root nodes (in ovals) represents a legal claim about which

HYPO has some knowledge: trade secrets misappropriation, breach of nondisclosure/noncompetition agreements and breach of contract. The rectangular nodes represent dimensions.

A solid arc upward from a dimension to a claim node indicates that in the CKB there is at least one case involving that claim where the court decided the claim because, or in spite, of the feature associated with that dimension. Note that some dimensions, such as *Agreed-Not-to-Disclose* and *Nondisclosure-Agreement-Specific*, are linked to more than one claim. This means that moving a case along such a dimension may affect the strength of the plaintiff's position on either claim, sometimes in opposite directions (i.e., strengthening on one claim and weakening on the other).

A dashed arc downward from one dimension to another indicates that the prerequisites of the lower dimension are a subset of those of the upper dimension such that if the upper dimension applies to a case, then the lower dimension either applies or is a near-miss. Thus, strengthening or weakening a claim by making the upper dimension apply to a case paves the way for a complimentary weakening or strengthening the claim by making the lower dimension also apply. For example, a case in which a trade secrets claim is weakened by introducing disclosures to outsiders so that *Secrets-Disclosed-Outsiders* applies can be strengthened by subjecting the disclosures to confidentiality restrictions so that the near-miss dimension *Outsider-Disclosures-Restricted* also applies. For another example, a case in which a claim for breach of a nondisclosure agreement is strengthened along *Agreed-Not-to-Disclose* can be weakened along the *Consideration* dimension if the employee failed to receive something of value for entering into the agreement. Note that while *Agreed-Not-to-Disclose* is linked to the trade secrets claim, there is no arc linking *Consideration* to the trade secrets claim. That means that there is no case in which the lack of consideration for a nondisclosure agreement has been held to weaken a plaintiff's trade secrets claim. That remains

an interesting legal possibility, however. As described in Chapter 12, HYPO can take advantage of this information to suggest that the lack of consideration should also be treated as a weakness for a trade secrets claim.

7.4 Advantages of Dimensions

To summarize, dimensions perform the following functions in HYPO:

1. Abstract relevant features and define relevant similarities and differences among precedents.
2. Enable determining how an analogous precedent can be best used in a legal argument, either cited in a point or as a counter-example.
3. Order precedents for various comparisons useful in selecting the best cases to cite and distinguishing cases.
4. Guide hypothetically modifying cases.

The advantages of dimensions are:

1. Reasoning within the Index
2. Model Independence
3. Minimized Interpretation
4. Modularity.

Reasoning within the Index: Dimensions support more sophisticated reasoning than an index traditionally supports. Of the four functions listed above,

only the first – retrieving relevant cases – is commonly performed by an index. The remaining functions:

1. Interpreting precedents' significance as justifications in arguments;
2. Ordering precedents so that they may be compared and contrasted dynamically;
3. Guiding hypothetical generation to fill a sparse case space.

are well beyond the kinds of reasoning we normally expect an index to support.

Model Independence: Dimensions support sophisticated reasoning in a domain that lacks a strong causal model. High level legal concepts lack definitions from which it can be inferred whether they apply to a given fact situation or not. For instance, there is no adequate description of the necessary and sufficient criteria of a valid trade secrets misappropriation claim. Dimensions bridge that gap by indexing positive and negative examples of the concept and providing a means for drawing conclusions about the applicability of the concept to a given fact situation from certain comparisons of it to those indexed examples. In other words, dimensions link surface features of fact situations to ways of justifying legal arguments about the fact situation even though the domain does not have a strong conceptual model of the linkage.

Minimized Interpretation: Dimensions cut down on the amount of interpretation needed by the person entering a case into the CKB. He need only record the facts expressly reported by the court, the claims and the court's decision of the claims. Although that in itself is an interpretive task, at least it requires less interpretation than determining what issues the courts decided and what rationales they used in their decisions.

Dimensions also cut down on the amount of interpretation needed by the person who invents new dimensions. Although lawyers probably would not recognize the concept of a dimension as corresponding to any legal concept, various legal knowledge sources are implicitly organized by something like dimensions. Legal treatises and law review articles commonly group together in footnotes cases that share some important feature. Within the footnote, the author includes for comparison cases that were won by defendants as well as plaintiffs and that show a range of magnitudes of the feature or a variety of additional counter-veiling features. The nature of the factual comparisons is usually evident from the author's comments or those of the cases reported. This is the primary source of HYPO's dimensions. Again, interpretation was required to assemble the footnotes, but at least the interpretation has been performed by a domain expert, the author, and shows positive and negative examples.

Modularity: Dimensions accord a certain measure of modularity. As new dimensions are added, inconsistency with existing dimensions is not a problem. 3-ply arguments exploit conflicts among dimensions by citing as counter-examples more-on-point cases that share additional, conflicting dimensions with the current fact situation relative to some cited precedent.

7.5 Figures

```
(make-instance
  'dimension
  :name 'secrets-voluntarily-disclosed
  :short-title "Secrets-Disclosed-Outsiders"
  :claims 'trade-secrets-misappropriation
  :prerequisites '(exists-claimant-corp1
    exists-respondent-corp2
    claimant-makes-product1
    corps-1-2-compete
    exists-claimants-info-re-product1
    exists-disclosures-info1)
  :near-miss-prerequisites '(exists-disclosures-info1)
  :focal-slot-prerequisites '(exists-disclosures-info1)

  :focal-slots
  '((exists-claimants-info-re-product1 number-disclosees))
  :ranges
  '(((type interval) (:values (0 10000000)) (:units disclosees)))
  :pro-p-directions '(less))
  :comparison-tests NIL)
```

Figure 23: The *Secrets-Disclosed-Outsiders* Dimension

```

(make-instance 'dimension
:name 'security-measures-adopted
:short-title "Security-Measures"
:claims 'trade-secrets-misappropriation
:prerequisites '(exists-claimant-corp1
                 claimant-makes-product1
                 exists-claimants-info-re-product1
                 exists-respondent-corp2
                 respondent-makes-product2
                 corps-1-2-compete
                 corps-1-2-compete-re-products-1-2
                 exists-info-re-security-measures)
:near-miss-prerequisites '(exists-info-re-security-measures)
:focal-slot-prerequisites '(exists-info-re-security-measures)
:focal-slots '((claimant-makes-product1 security-measures-list))
:ranges
'(((type more-v-less)
 (:values
  (*minimal-measures*
   *access-to-premises-controlled*
   *restrictions-on-entry-by-visitors*
   *restrictions-on-entry-by-employees*
   *product-marked-confidential*
   *employee-trade-secret-program-exists*
   *restrictions-on-hardcopy-release*
   *employee-nondisclosure-agreements*))))))
:pro-p-directions '((more))
:comparison-tests NIL)

```

Figure 24: The *Security-Measures* Dimension

```

(make-instance
 'dimension
 :name 'competitive-advantage-gained
 :short-title "Competitive-Advantage"
 :claim 'trade-secrets-misappropriation
 :prerequisites '(exists-claimant-corp1
  claimant-makes-product1
  exists-respondent-corp2
  respondent-makes-product2
  corps-1-2-compete-re-products-1-2
  corp2-saved-expense)

 :near-miss-prerequisites '(corp2-saved-expense)
 :focal-slot-prerequisites '(corp2-saved-expense)
 :focal-slots '(((claimant-makes-product1 expenditures-made)
  (respondent-makes-product2 expenditures-made))
 ((claimant-makes-product1 project-development-time)
  (respondent-makes-product2 project-development-time)))
 :ranges '(((type computed)
  (:values (10000000 10000)) (:units dollars) (:factors (.1 20)))
  ((:type computed)
  (:values (60 2)) (:units months) (:factors (.1 20))))
 :pro-p-directions '((greater)(greater))
 :comparison-tests (list 'compare-development-costs)
 :modification-procs
 '(modify-number-comparison)(modify-number-comparison)))

```

Figure 25: The *Competitive-Advantage* Dimension

NAME: USM CORP. V. MARSON FASTENER CORP. : ACR
CASE: <CASE : usm corp. v. marson fastener corp.>
INTERP-FRAME:
<INTERP-FRAME : USM CORP. V. MARSON FASTENER CORP. : INTERP-FRAME>
APPLICABLE-DIMENSIONS:
(<DIMENSION : COMPETITIVE-ADVANTAGE-GAINED>
<DIMENSION : SECURITY-MEASURES-ADOPTED>)
NEAR-MISS-DIMENSIONS:
(<DIMENSION : SECRETS-VOLUNTARILY-DISCLOSED>
<DIMENSION : VERTICAL-KNOWLEDGE>
<DIMENSION :
DISCLOSURE-IN-NEGOTIATIONS-WITH-DEFENDANT>)

Figure 26: Excerpts from Case-Analysis-Record for *USM* Case

NAME: USM CORP. V. MARSON FASTENER CORP. : INTERP-FRAME
CASE: <CASE : usm corp. v. marson fastener corp.>
EXISTS-CLAIMANT-CORP1: <CORPORATE-PARTY : USM>
CLAIMANT-MAKES-PRODUCT1: <PRODUCT : USM-MACHINE>
EXISTS-CLAIMANTS-INFO-RE-PRODUCT1: <KNOWLEDGE : ABOUT-
USM-MACHINE>
EXISTS-RESPONDENT-CORP2: <CORPORATE-PARTY : MARSON>
RESPONDENT-MAKES-PRODUCT2: <PRODUCT : MARSON-MACHINE>
CORPS-1-2-COMPETE: T
CORPS-1-2-COMPETE-RE-PRODUCTS-1-2: T
EXISTS-RESPONDENT-EMPLOYEE1: NIL
CORP2-ACCESS-PRODUCT1-VIA-EMPLOYEE1: NIL
CORP1-EMPLOYEE1-AGREEMENT: NIL
EXISTS-DISCLOSURES-INFO1: NIL
KNOW-WHAT-KIND-INFO1: NIL
CORP2-MADE-EXPENSE: (NIL (60 36))
EXISTS-INFO-RE-SECURITY-MEASURES:
(*MINIMAL-MEASURES*
ACCESS-TO-PREMISES-CONTROLLED
RESTRICTIONS-ON-ENTRY-BY-VISITORS
EMPLOYEE-NONDISCLOSURE-AGREEMENTS)
INFO1-DISCLOSED-CORPS-1-2-NEGOTIATIONS: NIL
CORP2-ACCESS-INFO1-VIA-DISCLOSURE: NIL
EXISTS-DATA-RE-SPECIFICITY: NIL
EXISTS-DATA-RE-SOLE-DEVELOPER: NIL

Figure 27: Excerpts from INTERP-FRAME for *USM* Case

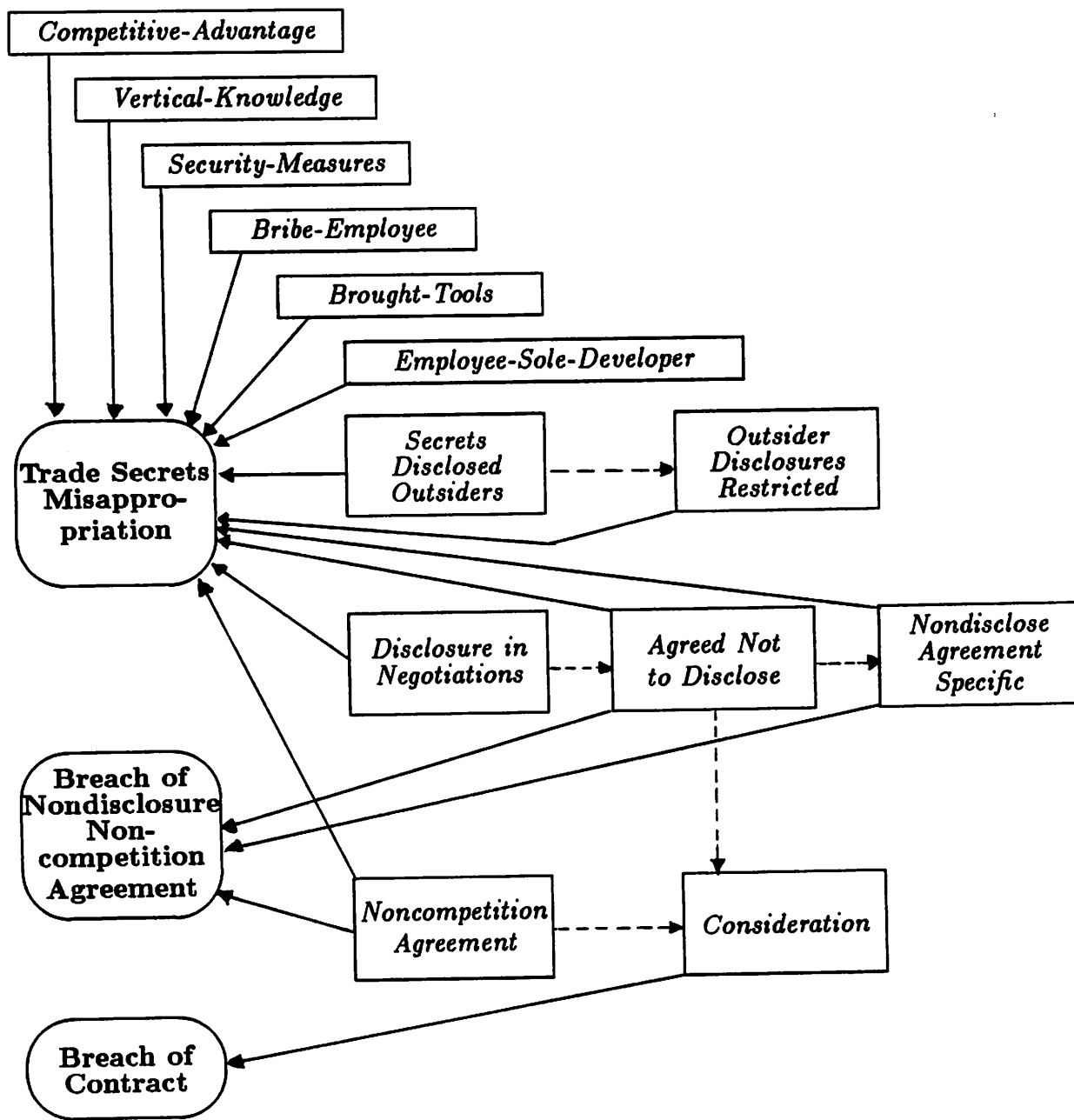

Figure 28: Relations among Claims and Dimensions

CHAPTER 8

Basic Mechanisms of Case-Based Reasoning

In order to assist an attorney to evaluate and make arguments about a new fact situation using precedents and hypotheticals, indexing and retrieval of relevant cases are not enough. IIYPO must compare cases relative to the current fact situation and interpret those comparisons in terms of their significance in a legal argument. HYPO needs to classify and organize the cases in terms of their uses in a legal argument, specifically, whether they are :

1. Citable in Points: Which cases make strong legal points pro or con a plaintiff's claim in a fact situation?
2. Citable in Responses: Which cases make strong responses as counter-examples to cases cited in points?
3. Potentially Citable: Which cases could make strong points or responses given a slightly modified fact situation? How do hypothetical modifications of the fact situation affect the strength of existing points and responses for an argument as to this and other claims.

In order to make these determinations, HYPO performs operations that are basic for case-based reasoning:

1. Ordering relevant cases and potentially relevant cases in terms of how analogous they are to the problem situation.

2. Selecting the most analogous cases.
3. Identifying configurations of counter-examples.
4. Hypothetically modifying the problem situation to explore contingencies.
5. Comparing case-based analyses of different problem situations to explain differences:

These basic operations allow a case-based reasoner to compare and contrast a problem situation with past experience and to take into account not only its similarities to past cases but also its differences.

Although the operations are general for case-based reasoning, the actual criteria for ordering, selecting, modifying and comparing cases will reflect the domain specific criteria of what constitutes relevancy and useful analogy. HYPO's criteria for comparing cases, drawn, in part, from the Argument Evaluation Criteria of Figure 6, comprise comparing cases in terms of:

1. On Pointness
2. Outcome
3. Magnitude of Shared Features
4. Potential Relevance as a Near-Miss

On Pointness is HYPO's basic symbolic measure of useful legal analogy between a fact situation and a precedent. A case is on point to the extent that a dimension that applies to the case is applicable to or a near-miss for the current fact situation. As described in Chapter 4 and below, on pointness is measured in a claim-lattice by the degree of overlap of dimensions shared by a precedent and the fact situation relative to that of other precedents.

Outcome means who won the precedent, plaintiff or defendant. Precedents are compared in terms of whether they have the same or different outcomes. It is somewhat easier to determine a case's outcome in law than in other domains: *First*, who won a precedent is a matter of historical record. *Second*, subject to some qualification, there are only two possibilities, either the plaintiff won the case or not.¹ *Third*, the problem solver knows which side he represents, plaintiff or defendant, and in any event, when he switches hats to take a contrary viewpoint, there is only one other hat to try. In other case-based domains, determining the outcome of a case requires more interpretation and there may be more than two sides to consider.

Magnitude of Shared Features is another way of comparing cases. Precedents are compared in terms of their positions along shared dimensions relative to each other and to the current fact situation. As described in Chapter 7, a case's position along the range of a dimension is a measure of the magnitude of the strength of the plaintiff's legal position in terms of that feature.

Potential Relevance as a Near Miss is a different way to gauge useful analogy. Precedents that are nearly on point but for some crucial missing facts (i.e., cases indexed by dimensions that are near-misses with respect to the fact situation) are compared to see which ones would be more on point if certain small hypothetical changes were made to the current fact situation.

In the remainder of this Chapter, we will examine the basic case-based operations in light of how HYPO performs them.

¹The qualification is that depending on the procedural context of the case, some outcomes are more determinative than others. A precedent that plaintiff won or lost after a full trial on the merits is a more authoritative determination of the issues than if it only resolves a preliminary motion. HYPO does not compare precedents' outcomes at that level.

8.1 Ordering Analogous Cases

Any case-based reasoner needs some mechanism for ranking the cases in terms of how analogous they are to the problem situation. The definition of relevant similarity will reflect the particular kind of problem-solving task performed by the case-based reasoner and the criteria for evaluating the solution. In HYPO, where the task is to make arguments and the criteria go to evaluating the strength of arguments, more analogous means more on point.

As described in Chapter 4, the CASE-POSITIONER employs claim-lattices to order cases in terms of on pointness with respect to a given fact situation. There are two kinds of claim-lattices, regular and extended, and they implement somewhat different senses of relative on pointness.

As previously defined, Case α is more on point than Case β if and only if the set of dimensions β has in common with a "reference set" of dimensions associated with the current fact situation are a proper subset of the set of α 's applicable dimensions shared with the reference set. In a regular claim-lattice, the reference set is the set of dimensions that apply to the current fact situation. In an extended claim-lattice, the reference set is the set of dimensions that apply to or are near-misses for the current fact situation.

The ordering scheme of claim-lattices, described in Chapter 4, captures a symbolic sense of closeness to the current fact situation of cases in the CKB. The root of the claim-lattice, represents the current fact situation. The closer a case is to the root, the more on point it is, that is, the more legally important strengths and weaknesses it shares with the fact situation. As one moves along a branch to the leaf nodes, the cases are less analogous because they have less of an overlap of dimensions with the current fact situation and therefore share fewer legally significant features.

Let's take a closer look at a very simple claim-lattice. Figure 29 shows the claim-lattice for the *USM* fact situation of Section 5.4. Each node of a claim-lattice consists of a list of dimensions and a list of cases. The root node's list of dimensions is the reference list. The reference list of a regular claim-lattice like that of Figure 29 shows that, as determined by the CASE-ANALYZER's dimensional analysis, two dimensions apply to the fact situation of the *USM* case: *Competitive-Advantage* and *Security-Measures*. The fact that the *Space Aero* case is in the root node's list of cases shows that it has the same applicable dimensions as the cfs and that, of all the cases in the CKB, it is the most on point to *USM*. The list of cases also shows that plaintiff (π) won *Space Aero*.²

Each of the other two nodes of Figure 29 shows all of the cases in the CKB that have the listed dimension[s] in common with the current fact situation. There are five cases that share only the *Security-Measures* dimension with the cfs and six cases that share only the *Competitive-Advantage* dimension with the cfs. Note that all eleven cases are less on point than the *Space Aero* case that shares both of those dimensions with the current fact situation.

A somewhat more complicated regular claim-lattice for the *Structural Dynam-*

²The root node's case list also includes the *USM* case. In this example, the *USM* case appears in two roles, both as:

1. The current fact situation; and
2. A case in the CKB.

The CASE-ANALYZER independently analyzed the *USM* case as the current fact situation to determine its applicable dimensions. Using the results of that analysis, the CASE-POSITIONER correctly retrieved the *USM* case from the CKB as a relevant precedent. That is why the case appears in the case list of some node of the claim-lattice. The *USM* case appears in the *root* node's list of cases as a result of the CASE-POSITIONER's treating the case as most on point to itself, which, of course, it is.

ics case of Section 5.3 is shown in Figure 33.³ Two cases from the CKB, *Amoco* and *Analogic* each share a maximal (but different) set of dimensions in common with the fact situation of *Structural Dynamics*. Every other relevant case from the CKB shares a set of dimensions with the root node that is a proper subset of the corresponding sets for those two cases. For example, the cases below the *Analogic* case in the claim-lattice are less on point than *Analogic*. The cases below *Amoco* are less on point than *Amoco*. Note also that the *Analogic* and *Amoco* cases had opposite outcomes, a fact that determines for which side they will be cited in arguments and whether they can be used as counter-examples to less on point cases.

By expanding the reference set to include dimensions that are near-misses as to the current fact situation, an extended claim-lattice loosens the criteria for defining what counts as analogous to include cases potentially on point. Figure 30 shows the extended claim-lattice for the *USM* case. The asterisks (*'s) following dimensions in the dimensions lists of the nodes of the extended claim-lattice indicate that those dimensions are near-misses with respect to the current fact situation. (Those dimensions are still applicable with respect to each of the cases in the particular node's case list.) Thus, in Figure 30, the *Disclosure-in-Negotiations* dimension is a near-miss with respect to the cfs but applies to the *Automated Systems* case. Note that the extended lattice graphs a larger number of cases than and actually subsumes the regular claim-lattice, reflecting the former's looser criteria for defining "relevantly analogous".

The claim-lattice and excerpts from the extended claim-lattice for the *Crown* case are shown in Figures 35 and 36. Note the difference in positions of the *Data*

³As in the previous claim-lattice, the *Structural Dynamics* case appears in the claim-lattice in two roles, as the current fact situation and as a case retrieved from the CKB. As always, the analysis of the current fact situation was conducted independently of the fact that the case was in the CKB.

General case in the two claim-lattices. In the regular claim-lattice, Figure 35, pro-plaintiff *Data General* is treated as as on point as the pro-defendant *Midland Ross* and *Yokana* cases. In the extended claim-lattice, Figure 36, however, the *Data General* case is more on point (i.e., closer to the root which is toward the bottom lower left of the figure out of view) than either of the other two cases. The significance of its position in the extended claim-lattice is that if the current fact situation were modified so that the *Outsider-Disclosures-Restricted* dimension applied, the *Data General* case would make a fine trumping counter-example to either the *Midland Ross* or *Yokana* cases with respect to which it would be more-on-point and have a contrary outcome.

8.2 Selecting Most Analogous Cases

Any case-based reasoner will also need to select the cases most analogous to the current fact situation. There may not be just one most analogous case. For one thing, the evaluation criteria may not be so well defined that it can be determined always or even often what the one best case is. For another, it may be useful for purposes of decision-making or explanation to define most analogous less restrictively to yield a larger set of alternatives. In any event, there may be a variety of definitions of most analogous, each serving a somewhat different function.

As described in Chapter 4 the CASE-POSITIONER uses claim-lattices to select three kinds of most analogous precedents:

1. Best-Cases-to-Cite;
2. Most-On-Point cases;
3. Most-On-Point Near-Miss cases;

The **Best-cases-to-cite** for a side are the cases in the CKB most analogous to the fact situation and making the most convincing points in favor of a side's position on a claim. They not only share the most features with the fact situation of any case holding for that side but at least some of the features represent strengths of the side's position. Best-cases-to-cite for a side (plaintiff or defendant) are selected from a regular claim-lattice. They are defined as those cases that are:

1. Citable for that side in the first instance.
2. Contained in the root or in nodes that are closer to the root than (or as close as) any node on that branch from the root which contains cases citable for either side.⁴

As described in Chapter 7, a precedent is citable in the first instance for a side on a claim if and only if the court held for that side on the claim and the precedent shares at least one applicable dimension favoring the side.

The **Most-on-point** cases for a side are somewhat more liberally defined by relaxing the requirement of citability. They are simply the most analogous cases in the CKB that were held in favor of a side. They may not make convincing points if cited in the first instance, but they may be useful to cite as counter-examples to pro-opponent cases that are as or less on point. Most-on-point cases for a side (plaintiff or defendant) are defined as those cases in the regular claim-lattice that were:

⁴This and the other definitions of most analogous cases can be made more restrictive by selecting the least distinguishable of the otherwise equivalent cases in a node of the claim-lattice. In other words, a node's cases could be screened in terms of least number of dimensions not shared with the cfs. This additional filter will be useful as the number of cases in the CKB, and the average number of cases per node, increase.

1. Won by that that side.
2. Contained in the root or in nodes that are closer to the root than (or as close as) any case-containing node on that branch from the root.

Most-on-point near-miss cases for a side are garnered from the extended claim-lattice. They are the cases in the CKB that would be most analogous to the fact situation if all of the dimensions that were near-misses to the fact situation suddenly applied. As such, these cases are potentially useful in making new points or responses. They are defined as those cases:

1. Won by that side.
2. To which applies at least one dimension that is a near-miss for the current fact situation and favors that side.
3. Contained in the root or in nodes that are closer to the root than (or as close as) any case-containing node on that branch from the root.
4. Not already a best case to cite.

The three types of most analogous cases selected by the BEST-CASE-SELECTOR for the *USM*, *Structural Dynamics* and *Crown* cases are shown in Figures 31, 32, 34 and 37. Each figure shows an excerpt from the case-analysis-records generated for the cases.⁵

Some highlights of the selection process are:

Not Comparing Apples and Oranges: The on pointness comparison of cases is confined to comparing cases on the same branch of the claim-lattice. Cases selected as most analogous from different branches (i.e., whose subsets of

⁵Best-cases-to-cite are shown in the "Best-Cases-By-Claim" slot of the case-analysis-record.

the current fact situation's reference set, though maximal, are overlapping or disjoint) are not deemed by the BEST-CASE-SELECTOR to be more or less on point than each other. That would be like comparing apples and oranges. In Figure 33, for example, the *Analogic* and *Amoco* cases are deemed equally on point despite the fact that the former has two dimensions in common with the cfs as compared to the latter's three. Similarly, the cases below the *Analogic* case are not necessarily less on point than the cases below the *Amoco* case. In this instance, some are (i.e., *Space Aero* and *Yokana*) and some are not (i.e., *Telex*, *Eastern Marble* and *Kewanee*) reflecting the fact that the claim-lattice is a graph.

Weeding out cases that are not the best cases to cite: As described above, the BEST-CASE-SELECTOR distinguishes between best-cases-to-cite and most-on-point cases. The difference is illustrated in Figures 31 and 32. The *Pressure Science* case, though a most-on-point case for the defendant, did not make the list of defendant's best cases to cite because the feature it shared with the cfs did not represent a strength of the defendant's case. In *Pressure Science* the defendant won *despite* the fact that it had gained a competitive head-start over the plaintiff. In trade secrets law, the fact that a defendant who has access to plaintiff's trade secrets gains a competitive head-start tends to show that it misappropriated plaintiff's trade secret. As described in Chapter 7, that knowledge is captured by associating with the dimension, here the *Competitive-Advantage* dimension, information that it represents a plaintiff's strength. Thus *Pressure Science* is not a very convincing case to cite in an initial argument that a defendant should win. *Pressure Science* does, however, make a great counter-example to cite in response to the argument by a plaintiff that a defendant should lose where it gained a competitive head-start. Similarly, in Figure 37, neither *Space Aero* or *Data General* are best cases to cite for the plaintiff but they do make good counter-examples.

8.3 Identifying Configurations of Counter-examples

All case-based reasoning involves recognizing and using cases as counter-examples. Case-based reasoners must:

1. Recognize the situations when there are conflicts among the most analogous cases. When cases equally analogous lead to contradictory results, the cases can be thought of as counter-examples to one another. Each case is a counter-example to the proposition that the fact situation should be decided in accord with the other.
2. Take the existence of counter-examples into account, for example, by calling attention to the conflicts or resolving them.

In most case-based reasoners, conflicts among most-analogous cases are resolved by the matcher. There is a static hierarchy of features. The case match with the highest score wins out. The static hierarchies are flawed. Although one feature may be more important than another in some or most cases, that may not be true if there are other counter-veiling features in a problem situation or where feature magnitudes may differ.

As HYPO's methods for selecting most analogous cases indicate, a matcher employing a static hierarchy of features for selecting among conflicting analogous cases is not appropriate where:

- So much depends on the comparison of the particular mixes of features presented in the problem situation and in the cases of the CKB.
- Explicating the comparisons and contrasts among a fact situation, the most analogous precedents and their counter-examples conveys so much information, as it does in legal argument.

Across case-based domains, the definitions and uses of counter-examples will differ. As defined in Chapter 4, the 3-PLY ARGUER looks for four kinds of counter-examples that have legal significance in light of the Criteria for Evaluating Arguments:

1. **More-on-point** – Cases that had a contrary outcome from and are more-on-point than a given case. These are good for citing as trumping counter-examples.
2. **Boundary** – Cases that had a contrary outcome from and are more extreme along a shared dimension than a given case.
3. **Overlapping** – Cases that had a contrary outcome from a given case even though they share some or all of the same features of that case in common with the current fact situation.
4. **Potentially more-on-point** – For each side, cases that are potentially most-on-point or more-on-point than opponents' cases. These are potential counter-examples and are the basis of hypothetical variations of the fact situation that turn up new points and stronger responses. They also illustrate how the arguments about a fact situation change as features are added, subtracted, exaggerated, or combined with features of conflicting cases.

The first three kinds of counter-examples are represented by the configurations in a regular or extended claim-lattice of cases having contradictory outcomes. For a given case, a counter-example is a case won by the opposing side and located as follows:

More-on-point counter-examples, if they exist, are located in nodes of a regular claim-lattice closer to the root on any of the branches connecting the case and the root.

Potentially more-on-point counter-examples are located in nodes of the extended claim-lattice closer to the root on any of the branches connecting the case and the root.

Overlapping counter-examples are located in the same node of the regular claim-lattice as the given case, or in any node whose list of dimensions contains one or more of the same dimensions as that of the node containing the given case.⁶

As described in Chapter 4, in finding counter-examples to a cited case, the ARGUER does not traverse the claim-lattice but more simply compares the cited case to the most-on-point or most-on-point near-miss cases which were selected by traversing the claim-lattices. However, the ARGUER does traverse the claim-lattice in looking for counter-examples that are less on point than a given case. Less-on-point counter-examples, a kind of overlapping counter-example, lie below (i.e., farther from the root than) a given case on the claim-lattice. Contrasting a precedent with a less-on-point counter-example is a good way to explain the legal significance of the precedent.

The 3-PLY ARGUER also looks for the *absence* of counter-examples more-on-point than a given case when it seeks nontrumped cases to cite in points. These are the best-cases-to-cite for each side for which there are no more-on-point proponent cases. As described in Chapter 4, the ARGUER compares the strengths of each side's argument in terms of whether the side can cite non-trumped cases: If only one side has such cases, that side has a stronger argument.

The various configurations of counter-example are illustrated in the claim-lattices of the figures below. In Figure 29, *Space Aero* is a more-on-point counter-example to any of the pro-defendant cases below it including the *Pressure Science*

⁶**Boundary** counter-examples are a particular kind of overlapping counter-example in which the contradictory case has an extreme value along a shared dimension.

case. Although the defendant won *Pressure Science* even though it gained a competitive advantage, in *Space Aero*, just as in the current fact situation, defendant not only gained a competitive head-start but plaintiff took security measures, too. In fact, there are no more-on-point counter-examples to the *Space Aero* case, a fact that the ARGUER takes into account in deciding that plaintiff has the stronger argument. As a look at Figure 30 will show, there are also no counter-examples potentially more-on-point than *Space Aero*. That means the ARGUER will not be able to suggest a hypothetical to strengthen defendant's response to citing the *Space Aero* case. By contrast, in Figure 36, the *Data General* case is potentially a more-on-point counter-example to the *Yokana* and *Midland Ross* cases. The ARGUER can suggest a hypothetical: if the disclosures in the cfs were subject to restrictions, *Data General* would be a trumping counter-example strengthening plaintiff's response to those cases. In Figure 33, the *Analogic* and *Amoco* cases are overlapping counter-examples. They each involved a nondisclosure agreement between plaintiff and defendant and came to contradictory results, but neither is more on point than the other.

By making it easy to find configurations of counter-examples, claim-lattices allow the program to recognize among the welter of relevant cases, those legally interesting patterns among contradictory cases that are the stuff of legal arguments.

8.4 Hypothetical Modifications to Explore Contingencies

All case-based reasoners should support posing hypothetical modifications of cases to explore the consequences of making a problem situation or retrieved analogous case more or less like other analogous cases, particularly counter-examples.

8.4.1 Suggesting Interesting Hypotheticals to Pose

HYPO generates hypotheticals to change the results of the comparisons among the most analogous cases and alter the resulting arguments in predictable and useful ways. HYPO has heuristics for generating hypothetical modifications of a seed case to make it more or less like one or more target cases. Interesting hypotheticals produced from particular seed / target case combinations are:

1. **CFS Spinoffs:** Hypotheticals posed using the current fact situation as a seed and a most-on-point near-miss case, especially a potential counter-example, as a target.
2. **Hybrids:** Hypotheticals posed using a pro- Π most-on-point case as a seed and a pro- Δ most-on-point case from a different branch of the claim-lattice as a target (or *vice versa*).

Posing CFS Spinoffs by hypothetically varying the current fact situation to make it more like a potential counter-examples is a good way to apprise an attorney of what kinds of facts could improve a response. Having found a suitable potential counter-example, the EXPLAINER poses a hypothetical based on the cfs as seed, but supplies the missing triggering facts of the near-miss dimensions associated with the potential counter-example. By recursively calling the basic processing loop on the hypothetical, the ARGUER generates new arguments which when compared with the old, point out the improvement in the response. A similar approach can be used to show the attorney how to make a new point in favor of a side. The EXPLAINER simply chooses as a target case a most-on-point near-miss case whose outcome favored that side.

Hybrids combine the pro-plaintiff features that the seed case shares with the current fact situation with the shared pro-defendant features of the target case. No case in the CKB has that particular combination of features. If it did, it

would have been more-on-point than either seed or target. Hybrids are interesting because they implicitly raise the issue of which of the competing features are more important and how such a case would be decided. The hybrid hypo can be made even more interesting by pushing the conflicting features to extremes. In oral arguments, courts often create hybrid hypotheticals to use in slippery slope arguments to put pressure on an attorney's position. Starting with a case cited by the attorney as the seed, the court poses hypotheticals making it look more and more like a case cited by his opponent. In the process, the attorney is forced to propose a criterion for drawing the line between the seed and target cases. Courts also pose hybrids as a way of noting that no decided case has ever presented that particular combination of features.⁷

8.4.2 Heuristics for Generating Hypotheticals

In order to generate a hypothetical from a seed case, the HYPO-GENERATOR first creates a copy of the seed case by dumping the copies of the legal-case-frames of the seed case into a file and re-instantiating them – with names modified to avoid obliterating the seed case, thus creating a new version of the seed case. The HYPO-GENERATOR then applies heuristic modification methods to modify the copied case.

The HYPO-GENERATOR has five heuristics for hypothetically modifying a case:

- H1. Pick a near miss dimension and modify the facts to make it applicable.
- H2. Pick an applicable dimension and make the case weaker or stronger along that dimension.

⁷See Chapter 3 for some examples of sophisticated uses of hypotheticals in arguments.

- H3. Pick a dimension related to one of the applicable dimensions and apply one of the other heuristics, particularly, 1 or 2.
- H4. Pick an applicable dimension and make the case extreme with respect to that dimension.
- H5. Pick a target case that is a win and, using 1 and 2, move the seed case toward it to create a near win.

Each of the heuristic methods is described below and illustrated with an example. In the descriptions below the case being modified is the version of the seed case.

H1. Enable a near miss dimension: To hypothetically modify a case according to this heuristic method, the HYPO-GENERATOR selects a near miss dimension and "fills in" the missing prerequisite. Since the dimension is a near-miss, the missing prerequisite is the triggering prerequisite, the one associated with the dimension's focal slot. As described in Chapter 4, the HYPO-GENERATOR invokes a store method to make the case satisfy the missing factual predicate. The store method instantiates underlying legal-case-frame objects, adds them to the case and makes appropriate cross references. For example, to make the near-miss dimension *Restricted-Disclosures* apply to a copy of the *Crown* case, the HYPO GENERATOR instantiates the missing triggering prerequisite, EXISTS-RESTRICTIONS-DISCLOSURES-INFO1, by making 100 % of the disclosures to outsiders be subject to confidentiality restrictions.

H2. Make a case weaker or stronger along an applicable dimension: The HYPO GENERATOR strengthens or weakens a case by changing the value of the dimension's focal slot in the case. The change can be made independently of, or relative to, the corresponding value in a target case. To accomplish the former strengthening/weakening, the GENERATOR simply changes the values of a focal slot in the manner specified by the range information of the dimension.

As described in Chapter 7, that range information specifies possible values of the focal slot and which kind of change will favor the plaintiff. The amount of the change is somewhat arbitrary. To accomplish a modification relative to a target case, for instance to strengthen, the GENERATOR adjusts the values of the focal slots of the copy of the seed case in the stronger direction so that it is farther out than the target case's value. For example, the GENERATOR makes the version of the *Crown* case even weaker along the *Secrets-Disclosed* dimension relative to a target case like *Midland-Ross* by *increasing* the number of disclosees in the version from 7 to 150. Since *Midland-Ross* was decided for the defendant because there were too many disclosees (100), the version of *Crown* has passed the 100-disclosee threshold thus losing the ability to distinguish *Midland-Ross* as in Argument [1] of the *Crown* extended example, Section 5.1.7. Note that plaintiff in the version of *Crown* can still rely on *Data-General* as a boundary counter-example and argue that since the plaintiff won in that case (with 6000 disclosees), it should still win with only 150. See Argument [1] of Section 5.1.7. HYPO could make the case weaker still by increasing the number of disclosees near or above 6000, the highest value of any case in the CKB or even greater (in a target-independent way) to the highest value allowed by HYPO.

H3. Generate a hypo on a related dimension: Two dimensions in HYPO are related when they favor opposite sides and there is a real case in which they both appear. The case may turn out to be a useful counter-example in the context of a current fact situation involving both dimensions. For example, the dimensions *Restricted-Disclosures* and *Secrets-Disclosed* favor conflicting sides and appear together with one another in the *Data-General* case which, as we have seen above, is a potentially more-on-point counter-example in the context of the *Crown* case. A case can be modified on a related dimension by adding facts sufficient to make the related dimension apply to it in a manner similar to that with heuristic H1. In light of *Data General's* strategic use as a counter-example, the above example of modifying the version of the *Crown* case so that

the *Outsider-Disclosures-Restricted* dimension applies is also an example of H3. In this example, the related dimension is also a near miss dimension but that need not always be true. A hypothetical generated on a conflicting dimension is interesting because it is an example of a case where, at least arguably, facts associated with one dimension can override the effects of the other dimension's facts. As discussed in Chapter 4, HYPO poses such hypotheticals to probe for ways to strengthen the response to a point.

H4. Examine an extreme case: To generate an extreme case, HYPO simply changes the value in the case of a dimension's focal slot to be an extreme of the range of possible values. This can also be done in either a target-based or target-independent manner. The former method pushes the slot value to the extreme actually existing in a case in the CKB, the latter simply pushes the slot value to its permissible extreme. For instance, the extreme case on the strongest end of the *Secrets-Disclosed* dimension for plaintiff would be 0 disclosees. The other extreme is the maximum value for number of disclosees in a case won by the plaintiff (i.e., 6000 in *Data General* and in HYPO (10,000,000)).

H5. Manipulating a near win: A near win hypo is one in which a version of a seed case which is strong for and was won by, let us say, the plaintiff is "moved" in the direction of a target case from the CKB that has been decided in favor of the defendant. Using methods H1 through H3, HYPO endows the version situation with the features that made the target case a strong case for the defendant. The resulting hypothetical is not as strong for the plaintiff as the seed; it is a near-win. An argument can be made, based on the pro-defendant target case, that the near-win hypo should be decided in favor of the defendant. Manipulating a near win is especially useful in generating hybrids of most-on-point cases. For example, in Figure 36, a hybrid can be created from the *Data General* and *Automated Systems* cases by creating a near-win using the former as seed and the latter as target. In *Automated Systems* the court held in favor of the

defendant where the confidential information that the plaintiff wanted to protect was about a customer's business operations, that is, the knowledge was about a "vertical market" and the plaintiff had disclosed the information to defendant in negotiations. The HYPO GENERATOR creates a near-win out of *Data General* as the seed by making the confidential information be vertical knowledge (i.e., be about customer business operations) and by introducing disclosures to defendant in negotiations. As a result, an argument could be based on *Automated Systems* that, in the near-win version of *Data General*, the defendant should win.

The 3-PLY ARGUER directs the HYPO-GENERATOR as to which applicable, near-miss or related dimensions to use in modifying the version of the seed case with the five heuristic methods and what target values to use, if any. Given a seed and target case, the ARGUER computes the relevant differences between them and generates a specification for a hypothetical. For a CFS Spin-off, the relevant differences are some of the same differences that the ARGUER would use to distinguish the target case from the seed:

1. Unshared dimensions, applicable to the target but near-misses as to the seed that favor the side of the target's winner;
2. Differences along shared dimensions that favor the side of the target's winner.

The specification for a hypothetical, including the seed case, target case (if any) and relevant differences, is passed along to the HYPO-GENERATOR module.

Figure 38 shows some of the hypothetical modifications suggested by the EXPLAINER to explore the possible legal ramifications implicit in the *Crown Extended Example*, Section 5.1.7. The first two hypotheticals suggest how to bolster responses to points in Arguments [1] and [4]. The last three suggest the bases for

three new points.

The results of generating a hypothetical are shown in the *Crown* Extended Example, Section 5.1.7 where a CFS Spin-off, Version-4 of the *Crown* case, has been generated using H3 and H1. Version-4 has the same facts as the *Crown* case, except for one modification: all seven disclosures to outsiders are now subject to restrictions.

As indicated in the series of hypothetical modifications suggested in Figure 38, HYPO generates versions of the *Crown* case that strengthen or weaken the plaintiff's position in other ways.⁸ The first two suggested modifications are implemented by method 3 moves to related, conflicting dimensions (i.e., *Outsider-Disclosures-Restricted* in 1; *Competitive-Advantage-Gained* and *Security-Measures* in 2.) The conflict relations among the dimensions were noted by the 3-PLY ARGUER in identifying *Data General* and *Space Aero* as potentially more-on-point counter-examples. Suggested modifications 3, 4 and 5 are implemented with method 1 moves to near-miss dimensions. The 3-PLY ARGUER focussed on particular near-miss dimensions because it discovered most-on-point near-miss cases with those dimensions that could be cited on behalf of plaintiff or defendant. In suggested modification 6 the version is moved past the values in *Midland-Ross* to the extreme value in *Data General* and beyond. The program does not know to speculate that a secret told to 10,000 people is not a secret, even if they promise not to tell anyone else, but the program does know that two dimensions in *Data General* conflict and that moving to an extreme on one dimension may cause the conflict to be moot.

HYPO's model of dimensions and its heuristics for generating hypotheticals are general enough to analyze the sequences of hypotheticals posed by the Supreme Court Justices as illustrated in Chapter 3. The hypotheticals about the

⁸The attorney can opt to have the modifications made serially to the same copy of a seed case or separately, each to a different copy of the case.

civic creche display from the *Lynch* case oral argument can be analyzed as follows: The Justices make the basic fact situation weaker and stronger along a dimension that might be called *focus-of-attention*: they remove all of the secular images leaving only the religious one, they physically shrink the symbol to an extreme and relegate it to a corner or they remove the religious symbols and leave the secular ones. They weaken plaintiff's case along the dimension of *civic-content-message* by moving it to a municipal art museum or the frieze of a courtroom. They compare the case along the dimension of *government-involvement* to an extreme example, the Pope's mass on the Mall.

Similarly, the hypotheticals of the *Sony* case oral argument can be analyzed in terms of heuristic moves along dimensions. There, the Court repeatedly weakened the case for the plaintiff along the dimension of *possible-noninfringing-use* changing the values of the focal slot, percent of uncopyrighted sources of the work, from 10 % to 50 %. The attorney took the final step of weakening it further to an extreme case – 99.99 % of the programs being uncopyrighted – as a means of rhetorically underscoring the significance of strengthening the case along a conflicting dimension *known-infringing-uses* by posing that the defendant knew that .01 % of programs that were copyrighted were being infringed.

8.5 Comparing Case-Based Analyses of Different Problem Situations

All case-based reasoners should support comparing case-based analyses of different problem situations as a tool for explanation. One excellent way of explaining a case-based analysis is by contrasting it to the analysis of a fact situation similar but for some crucial differences. In addition, the results of the comparison can be used to draw conclusions about the original analysis. Good fact situations to compare are the problem situation and a hypothetical variant of it

or a retrieved case and a counter-example.

The 3-PLY-ARGUER compares the strength of arguments that can be made in favor of a claim in different fact situations by comparing claim-lattices. For example, to demonstrate the effects on an argument of a hypothetical change in the facts, the program compares the claim-lattices before and after the change. Changes in the number of and relationships among the most analogous cases indicate shifts in the balance of the argument (e.g., introducing a new best-case-to-cite for a particular side to cite or supplanting an old one with a new most-on-point counter-example).

The results of one such comparison is shown in the **Comparisons** part of Section 5.1.7 of the *Crown* Extended Example. The arguments that can be made in the context of two related fact situations, the *Crown* case and hypothetical version-4 of the *Crown* case are compared. The overall difference in the arguments is shown in the Citation Summary for version-4. Where previously only the defendant could make untrumped points, now both plaintiff and defendant can make such points. Furthermore, as the comparison of Arguments [1] and [5] show, the response to the point citing the *Midland Ross* case is improved; *Data General* can be cited in the response as a trumping counter-example. The moral to be drawn by the attorney from the comparison is: Find out whether the disclosures are restricted in the *Crown* case.

The underlying comparison among claim-lattices that gives rise to the above differences in argument may be seen by comparing Figures 36 and 39. The former shows an excerpt of the extended claim-lattice for the *Crown* case; the latter shows the extended claim-lattice for a variant of the *Crown* case in which the disclosures to outsiders have been made subject to restrictions. In Figure 39, the *Secrets-Disclosed-Outsiders* has changed from a near-miss to an applicable dimension. The *Data General* case has changed from being a counter-example potentially more-on-point than *Midland-Ross* to being a real trumping counter-

example.

8.6 Figures

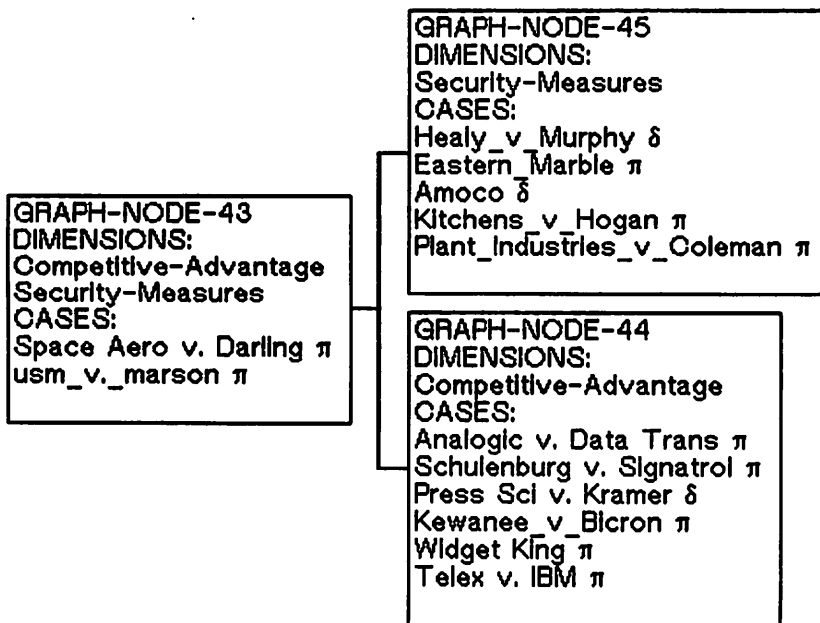

Figure 29: Claim-Lattice for Trade Secrets Claim in *USM* Case

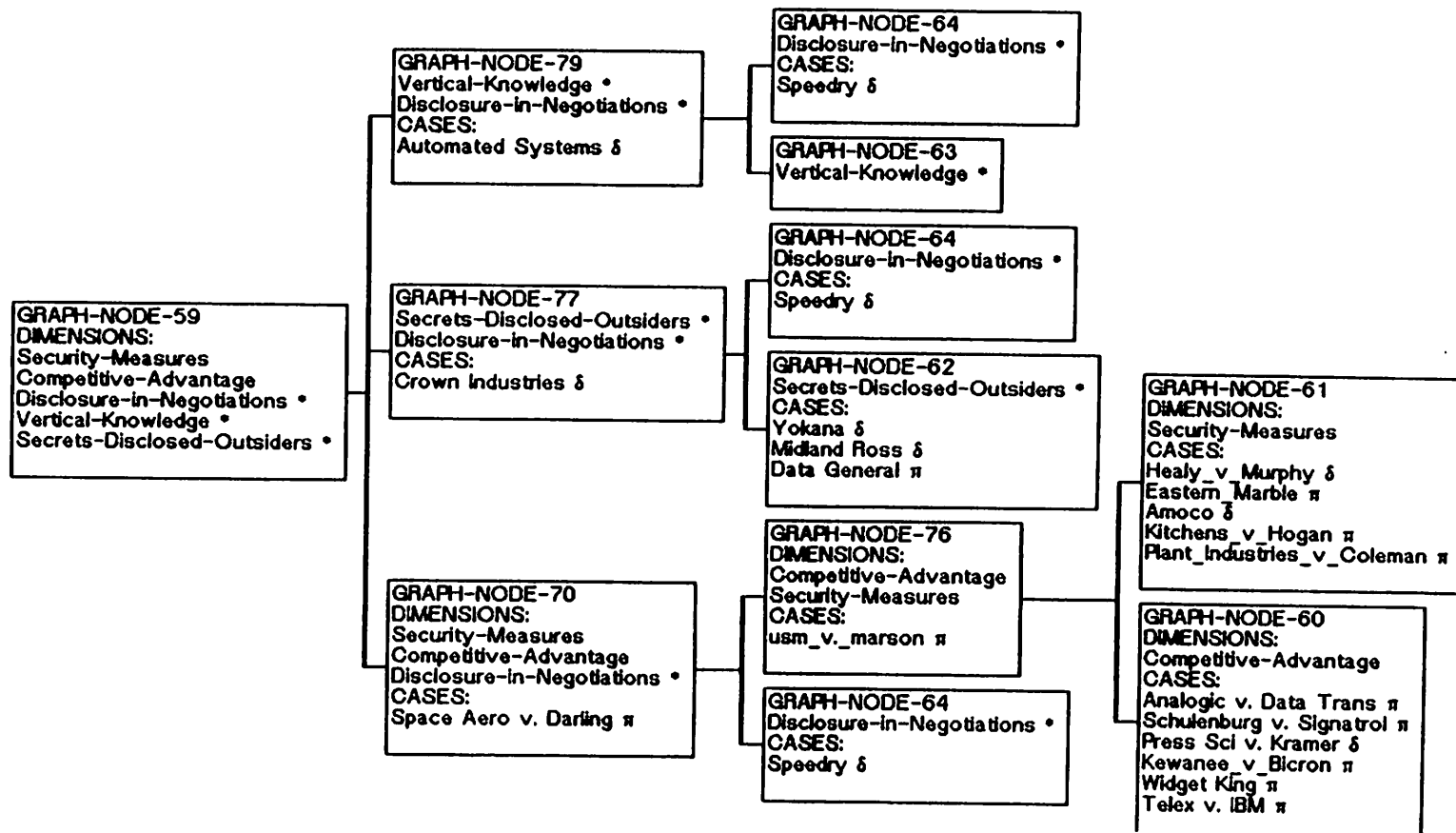

Figure 30: Extended Claim-Lattice for Trade Secrets Claim in USM Case

MOST-ON-POINT-CASES-BY-CLAIM:

((<TYPE-OF-CLAIM : TRADE-SECRETS-MISAPPROPRIATION>
(PLAINTIFF

<CASE : telex corp. v. ibm corp. (1)>

<CASE : Widget-King v. Cupcake>

<CASE : Kewanee Oil Co. v. Bicron Corp.>

<CASE : Schulenburg v. Signatrol, Inc.>

<CASE : Analogic Corp. v. Data Translation, Inc.>

<CASE : Plant Industries, Inc. v. Coleman>

<CASE : Peggy Lawton Kitchens, Inc. v. Hogan>

<CASE : Eastern Marble Products Corp. v. Roman Marble, Inc.>

<CASE : Space Aero Products Co. v. R.E. Darling Co.>)

(DEFENDANT

<CASE : Pressure Science, Inc. v. Kramer>

<CASE : Amoco Production Co. v. Lindley>

<CASE : Healy, Inc. v. Murphy, Inc. >)))

MOST-ON-POINT-NEAR-MISS-CASES-BY-CLAIM:

((<TYPE-OF-CLAIM : TRADE-SECRETS-MISAPPROPRIATION>
(PLAINTIFF)

(DEFENDANT

<CASE : Speedry Chemical Products, Inc. v. Carter's Ink Company>

<CASE : Crown Industries Inc. v. Kawneer Co.>

<CASE : Automated-Systems v. Service-Bureau>)))

**Figure 31: Most-On-Point Cases from Case-Analysis--
Record for *USM* Case**

BEST-CASES-BY-CLAIM:

(((<TYPE-OF-CLAIM : TRADE-SECRETS-MISAPPROPRIATION>
(PLAINTIFF
<CASE : telex corp. v. ibm corp. (1)>
<CASE : Widget-King v. Cupcake>
<CASE : Kewanee Oil Co. v. Bicron Corp.>
<CASE : Schulenburg v. Signatrol, Inc.>
<CASE : Analogic Corp. v. Data Translation, Inc.>
<CASE : Plant Industries, Inc. v. Coleman>
<CASE : Peggy Lawton Kitchens, Inc. v. Hogan>
<CASE : Eastern Marble Products Corp. v. Roman Marble, Inc.>
<CASE : Space Aero Products Co. v. R.E. Darling Co.>)
(DEFENDANT)))

**Figure 32: Best-Cases-by-Claim from Case-Analysis-Record
for *USM* Case**

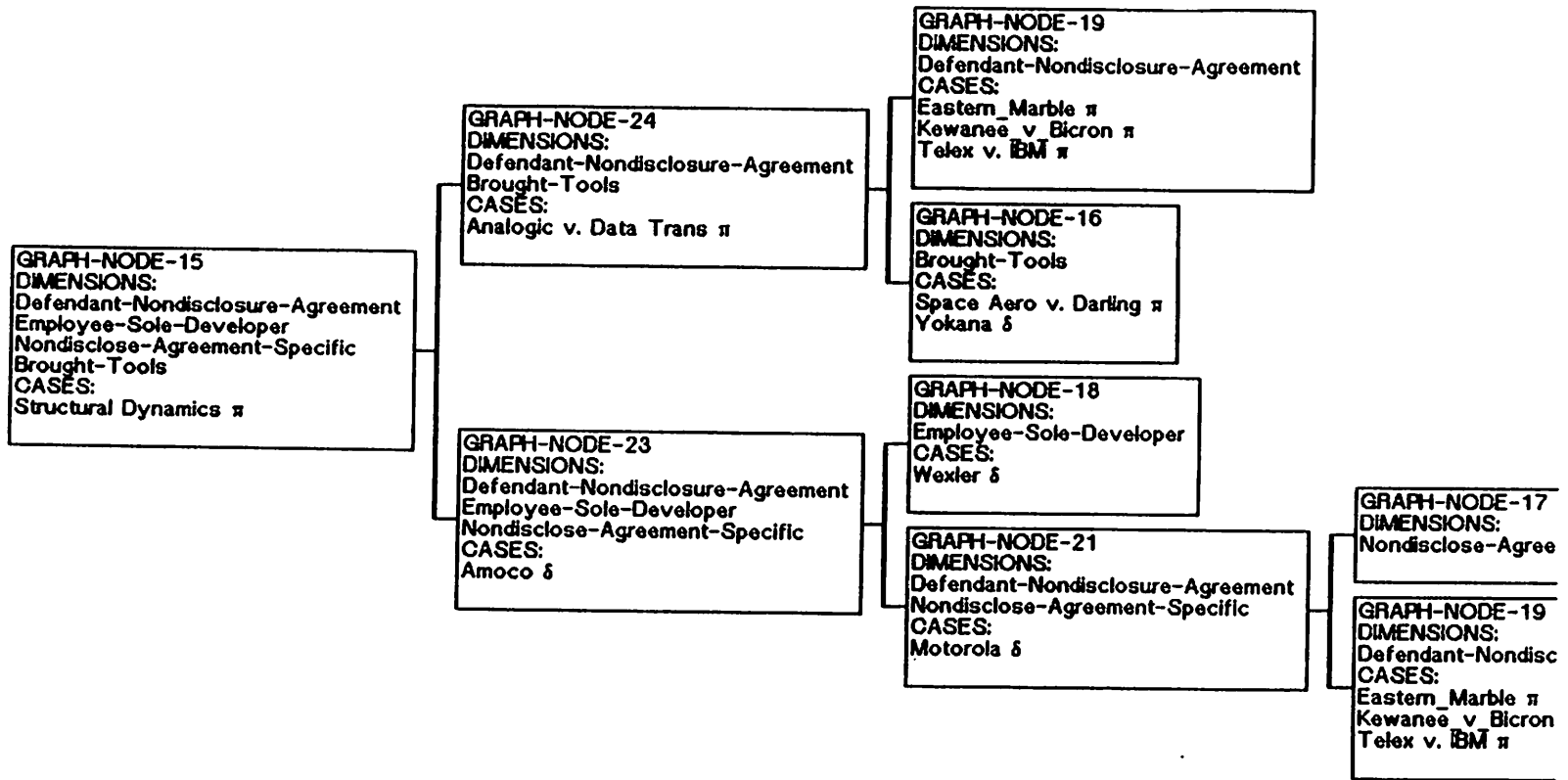

Figure 33: Claim-Lattice for Trade Secrets Claim in *Structural Dynamics* Case

NAME:
STRUCTURAL DYNAMICS RESEARCH CORP. V.
ENGINEERING MECHANICS RESEARCH
CORP. : ACR CASE:
 <CASE : structural dynamics research corp. v.
 engineering mechanics research corp.>
MOST-ON-POINT-CASES-BY-CLAIM:
 ((<TYPE-OF-CLAIM : TRADE-SECRETS-MISAPPROPRIATION>
 (PLAINTIFF
 <CASE : Analogic Corp. v. Data Translation, Inc.>
 (DEFENDANT
 <CASE : Amoco Production Co. v. Lindley>)))
MOST-ON-POINT-NEAR-MISS-CASES-BY-CLAIM:
 ((<TYPE-OF-CLAIM : TRADE-SECRETS-MISAPPROPRIATION>
 (PLAINTIFF
 <CASE : Eastern Marble Products Corp. v. Roman Marble, Inc.>
 <CASE : Analogic Corp. v. Data Translation, Inc.>
 <CASE : Space Aero Products Co. v. R.E. Darling Co.>
 <CASE : telex corp. v. ibm corp. (1)>
 (DEFENDANT
 <CASE : Crown Industries Inc. v. Kawneer Co.>
 <CASE : midland-ross corp. v. yokana>
 <CASE : Automated-Systems v. Service-Bureau>
 <CASE : Midland-Ross Corp. v. Sunbeam Equipment Corp.>)))
BEST-CASES-BY-CLAIM:
 ((<TYPE-OF-CLAIM : TRADE-SECRETS-MISAPPROPRIATION>
 (PLAINTIFF
 <CASE : Analogic Corp. v. Data Translation, Inc.>
 (DEFENDANT
 <CASE : Amoco Production Co. v. Lindley>)))

Figure 34: Excerpts from Case-Analysis-Record for *Structural Dynamics Case*

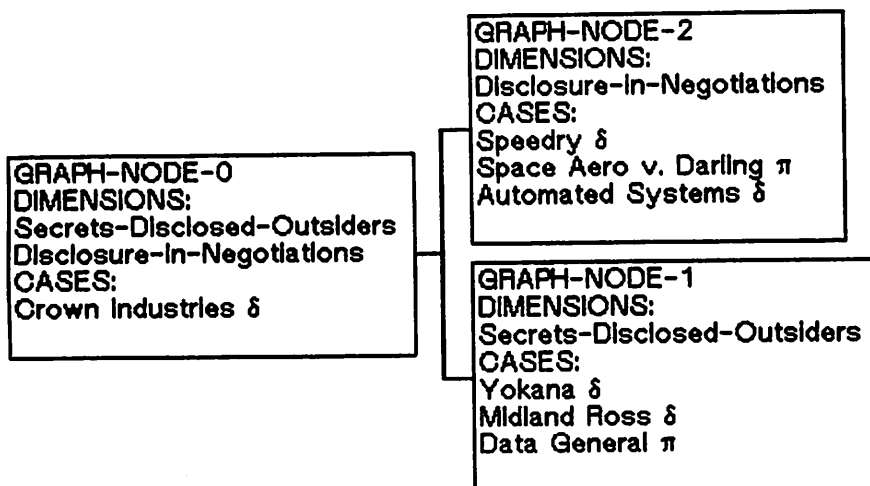

Figure 35: Claim-Lattice for Trade Secrets Claim in *Crown Case*

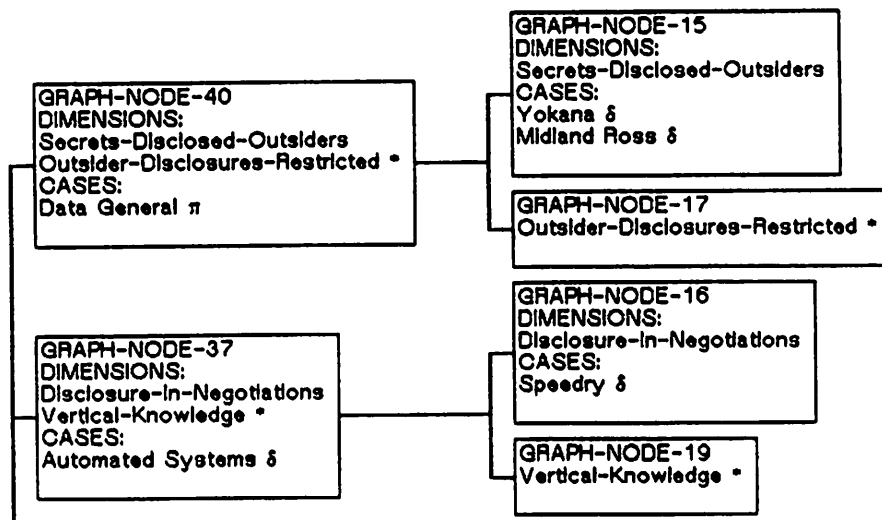

Figure 36: Excerpt of Extended Claim-Lattice in *Crown*

MOST-ON-POINT-CASES-BY-CLAIM:

((<TYPE-OF-CLAIM : TRADE-SECRETS-MISAPPROPRIATION>
 (PLAINTIFF
 <CASE : Data General Corp. v. Digital Computer Controls Inc.>
 <CASE : Space Aero Products Co. v. R.E. Darling Co.>)
 (DEFENDANT
 <CASE : Midland-Ross Corp. v. Sunbeam Equipment Corp.>
 <CASE : midland-ross corp. v. yokana>
 <CASE : Automated-Systems v. Service-Bureau>
 <CASE : Speedry Chemical Products, Inc. v. Carter's Ink Company>)))

MOST-ON-POINT-NEAR-MISS-CASES-BY-CLAIM:

(<TYPE-OF-CLAIM : TRADE-SECRETS-MISAPPROPRIATION>
 (PLAINTIFF
 <CASE : Eastern Marble Products Corp. v. Roman Marble, Inc.>
 <CASE : telex corp. v. ibm corp. (1)>
 <CASE : Kewanee Oil Co. v. Bicron Corp.>
 <CASE : Analogic Corp. v. Data Translation, Inc.>
 <CASE : Space Aero Products Co. v. R.E. Darling Co.>
 <CASE : Data General Corp. v. Digital Computer Controls Inc.>)
 (DEFENDANT
 <CASE : Automated-Systems v. Service-Bureau>)))

BEST-CASES-BY-CLAIM:

((<TYPE-OF-CLAIM : TRADE-SECRETS-MISAPPROPRIATION>
 (PLAINTIFF)
 (DEFENDANT
 <CASE : Midland-Ross Corp. v. Sunbeam Equipment Corp.>
 <CASE : midland-ross corp. v. yokana>
 <CASE : Automated-Systems v. Service-Bureau>
 <CASE : Speedry Chemical Products, Inc. v. Carter's Ink Company>)))

Figure 37: Excerpts from Case-Analysis-Record for *Crown* Case

1. PLAINTIFF's response would be strengthened if: Plaintiff's disclosures to outsiders were restricted. Cf. *Data General Corp. V. Digital Computer Controls Inc.* 357 A.2d 105 (Del. Ch. 1975) (e.g., see argument [1])
2. PLAINTIFF's response would be strengthened if: Defendant's access to plaintiff's product information saved it time or expense. Plaintiff adopted security measures. Cf. *Space Aero Products Co. V. R.E. Darling Co.* 208 A.2d 74 (Ct.App., Md., 1965) (see argument [4])
3. PLAINTIFF's position would be strengthened in following situations: SUPPOSE:
 - (a) Plaintiff and defendant entered into a nondisclosure agreement. Plaintiff adopted security measures. Cf. *Eastern Marble Products Corp. V. Roman Marble, Inc.* 364 N.E.2d 799 (Mass. 1977)
 - (b) Defendant's access to plaintiff's product information saved it time or expense. Plaintiff and defendant entered into a nondisclosure agreement. Cf. *Telex Corp. V. Ibm Corp.* (1) 510 F.2d 894 (10 Cir., 1975)
4. DEFENDANT's position would be strengthened in following situations: SUPPOSE:
 - (a) Plaintiff's product information was about customer business relations. Cf. *Automated-Systems V. Service-Bureau* 401 F.2d 619 (10 Cir., 1968)
 - (b) Plaintiff disclosed to 6000 outsiders, as many as in *Data General*. Suppose it disclosed to 10,000? or 10,000,000?

Figure 38: Hypothetical Variations of the *Crown* Case Suggested by HYPO

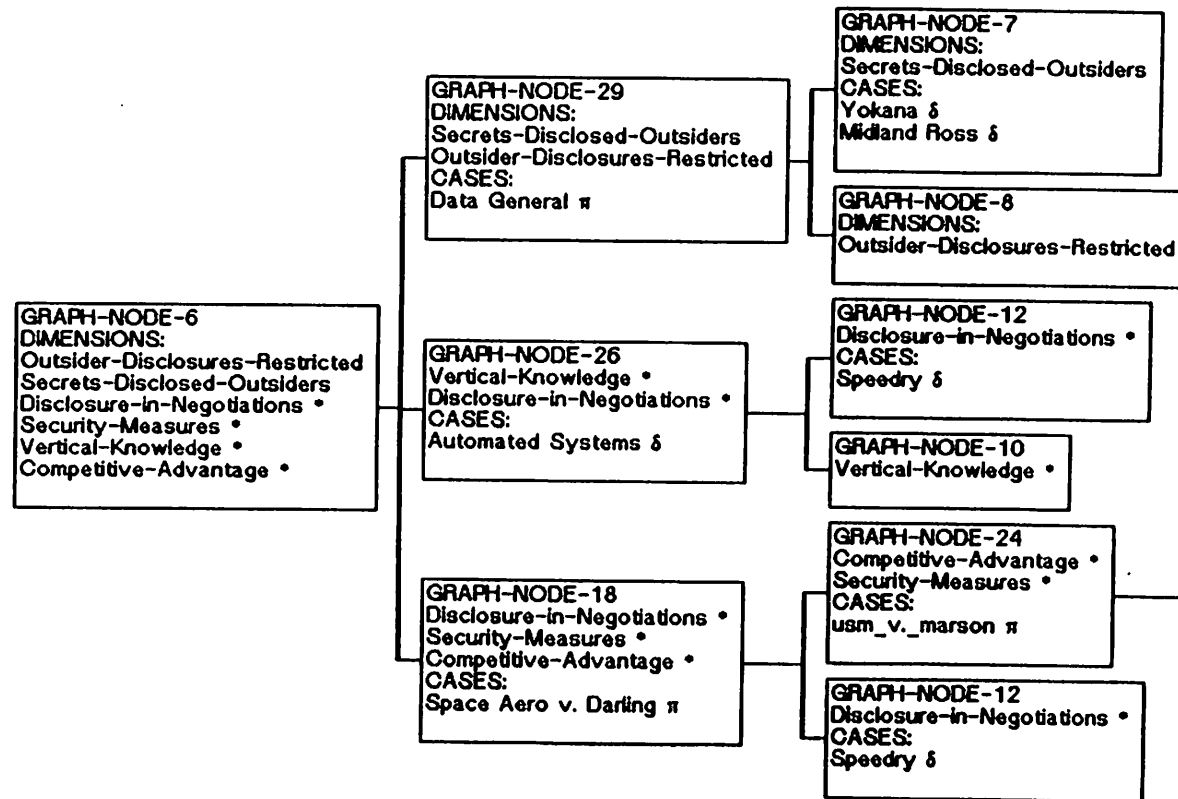

Figure 39: Extended Claim-Lattice for Trade Secrets Claim in Variant of *Crown* Case where Disclosures are Restricted

CHAPTER 9

Case-Based Argument in HYPO

In this chapter, we highlight some general aspects of arguing by analogy to precedents as illustrated by HYPO's output. Specifically, we look at:

1. Roles precedents play in making and responding to arguments by analogy.
2. Selecting the best analogies to draw.
3. Explaining with case-based arguments.

9.1 Roles Precedents Play in Making and Responding to Arguments by Analogy

As described in Chapter 2 and 3, making arguments by analogizing a fact situation to prior cases, and responding to those arguments, involve three basic operations:

1. Drawing the analogy to a precedent.
2. Distinguishing the precedent.
3. Citing other precedents as counter-examples to the precedent.

Precedents thus play a number of roles in legal analogical argument, and the legal significance of a given precedent depends on the role it is playing. In HYPO's 3-Ply Arguments a given precedent may appear in any of the following roles, as a:

1. Cited case in a point;
2. Cited case distinguished in a response or rebuttal;
3. Cited case in response to which another precedent is cited as a counter-example.
4. Counter-example in a response, in particular as a:
 - (a) Trumping counter-example;
 - (b) Boundary counter-example;
 - (c) Overlapping counter-example;
 - (d) Potentially more-on-point counter-example.
5. Target case for a hypothetical, suggested as a way either to:
 - (a) Bolster a response;
 - (b) Make a new point.
6. Current fact situation about which 3-Ply Arguments are made.

All of the roles precedents play in HYPO are illustrated below in Figures 42 through 50¹, each of which deals with one precedent, the *Data General* case, in different capacities:

Figures 42 through 44 show how the *Data General* case is cited in points and distinguished in responses with respect to three different current fact situations: the *Crown* case, the hypothetical variant of the *Crown* case, and the *USM* case.

¹A squib for the *Data General* case may be found in Appendix G.

Figure 45 shows how *Data General* is cited in Argument [1] of the *Crown Extended Example*, Section 5.1.7, first as a boundary counter-example in the response and then as a potentially more-on-point counter-example to suggest a way to bolster the response. The current fact situation is the *Crown* case.

Figure 46 shows how *Data General* is cited as a trumping counter-example in a response from Argument [5] of the *Crown Extended Example*, Section 5.1.7. The current fact situation is the hypothetical variant, Version-4 of the *Crown* case.

Figure 47 shows how *Data General* is cited as a most-on-point near-miss case to suggest the basis of a new point in the Suggested Hypotheticals of Section 5.1.7 where the current fact situation is the *Crown* case.

Figures 48 through 50 show the citation summary and 3-ply arguments generated when *Data General* is the current fact situation.

In HYPO, as in law, the significance and description of a given precedent depend on the following factors, each of which will be examined in light of the Figures:

1. Factual context of the current fact situation in which the precedent is cited.
2. Role that the precedent is playing.
3. Type of counter-example the precedent appears as.
4. Other cases in the CKB.
5. Kind of response that can be made to a point citing the precedent.

The factual context of the particular current fact situation has three effects on the significance of a given predicate:

First, as the current fact situation and precedent share more important features, the precedent becomes more on point and the response to citing it becomes weaker as fewer distinctions or fewer counter-examples can be made. This effect is demonstrated in Figures 42 through 44. The more extensive analogy drawn in

the point and fewer distinctions cited in the response of Figure 43 as compared to Figure 42 show that the cited case, *Data General*, is closer to the current fact situation of the former than of the latter. In Figure 44, where *Data General* and the current fact situation (the *USM* case) have nothing in common, the response cites lots of distinctions and counter-examples showing that the precedent is a very weak one in that context.

Second, as the current fact situation shares more important features with a precedent, the precedent's role as a counter-example changes. A progression from a potentially more-on-point counter-example to a trumping counter-example is demonstrated in Figures 45 where the current fact situation is the *Crown* case and 46 where the current fact situation is the hypothetical variant of *Crown*. The much stronger response in Figure 46 reflects the change in the status of the *Data General* case as a counter-example.

Third, a precedent's role as counter-example may also change as the current fact situation's position along a shared dimension changes relative to that of the precedent. For example, while *Data General* is a boundary counter-example for the *Crown* case with 7 disclosees as in Figure 45, it would not be for a hypothetical variant of *Crown* with 7000 disclosees because then it would not be more extreme than the cfs.

The effect on a precedent's significance of the role it plays in an argument may be demonstrated by comparing Figures 45 and 47. Where the precedent is suggested as a target for a hypothetical in the context of a specific point/response, the EXPLAINER tells the attorney specifically how the precedent can be used to bolster the response. This was done with the hypothetical based on *Data General* in Figure 45. By contrast, a different use – to build a new point – is recommended for the hypothetical in Figure 47 where it has not been related to an existing point/response.

If the precedent plays the role of a counter-example, its significance depends on what type of counter-example it is. For example, when cited as a boundary counter-example in Figure 45, the *Data General* case implies that disclosures to outsiders are not a legal weakness for plaintiff after all where a plaintiff can still win having made so many of them. When cited as a trumping counter-example in Figure 46, the same precedent also implies that restrictions on disclosures counter the negative legal effect for the plaintiff of the disclosures in the current-fact-situation. Thus a small change in the cfs introduced a second interpretation of the significance of the precedent.

The significance of a precedent also depends on what other cases happen to be in the CKB when the argument is made. For example, consider the rebuttal in Figure 45. If there were a case in the CKB which had been won by the plaintiff and had both disclosures to outsiders and disclosures to the defendant in negotiations, then that case would have been a better precedent than *Data General* to cite as a counter-example in the argument because it would have been more on point. Indeed, it would have been a trumping counter-example.²

The kinds of responses that can be made to citing a precedent in a given fact situation also affect its significance. As described in Chapter 4, HYPO makes four types of responses:

1. Trumping – citing a more-on-point counter-example to trump a point citing the precedent. A trumping response says, in effect, that the cited precedent is fine as far as it goes, but that when one considers the effect of important additional shared features of the trumping counter-example, the opposite result is warranted. Figure 46 shows how the cited precedent *Midland Ross* is trumped by *Data General*.

²Such a case is a hybrid of *Data General* and *Automated Systems*. As described in Chapter 8, HYPO has methods of identifying and generating hybrid hypotheticals.

2. **Partial** – citing an as-on-point or overlapping counter-example. Although a partial response cites a counter-example, the counter-example is distinguishable from the current fact situation or at least is no more on point than the cited precedent. A partial response, however, at least shows that cases have come to the opposite result with some or all of the features of the cited precedent. Figure 45 shows how *Data General* is cited in a partial response as a less-on-point counter-example to the cited precedent *Midland Ross*.
3. **Disparaging** – asserting that the current fact situation is a milder case than the cited precedent because the magnitudes of shared features are less. In addition to distinguishing the cited precedent, a disparaging response may also cite boundary counter-examples to show how much worse the magnitudes can be without necessitating the outcome in the precedent. The response in Figure 45 is also a disparaging one in so far as it points out that *Midland Ross* involved more disclosures to outsiders and cites *Data General* as a boundary counter-example to show how many more disclosures there can be without resulting in plaintiff's loss.
4. **Alternative Explanation** – showing that the comparison between the current fact situation and cited precedent is not fair because there were other features, not shared by the cfs and cited precedent, that independently explain why the two should be decided differently. The response in Figure 42 provides an alternative explanation for why *Data General* was won by plaintiff: in *Data General*, the disclosures were subject to restriction, and beside, there were no disclosures in negotiations to the defendant as there were in the cfs.

A final role that a precedent can play in HYPO is as a current fact situation to be analyzed and argued about in light of the other precedents in the CKB. Figures 48 through 50 demonstrate what arguments can be made for the parties

in *Data General*. Given the state of the CKB, only pro-defendant arguments can be made because *Data General* happens to be the only case in the CKB involving disclosures to outsiders where the plaintiff won.

9.2 Selecting Which Analogies to Draw

The question of selecting which analogies to draw comprises two issues, selecting which:

1. Prior cases to draw an analogy to.
2. Features of a given analogous case to focus on in a given context.

In HYPO, the former is the issue of, given a fact situation, deciding which precedents should be cited in points and as counter-examples in responses. The issue has been discussed in detail in Chapter 4, describing the algorithms of the BEST CASE SELECTOR, and Chapter 8, describing the criteria for selecting most analogous cases and identifying configurations of counter-examples. There the emphasis was on how the the domain-specific Criteria for Evaluation of Arguments were intimately bound to the selection of which precedents were best for justifying a legal position.

Given the selection of a precedent to employ in a role, the second issue involves salience, deciding what aspects of the analogy (or of the "dis-analogy") between the current fact situation and precedent to focus attention on. Like its significance, how a precedent is described by the 3-PLY ARGUER and the EXPLAINER depends on the particular factual context and argument role played by the precedent. Although in HYPO, at present, the only features which are available for describing relevant similarities or differences are those associated

with the dimensions, there still are decisions to be made about which of those similarities or differences to call attention to in a given context.

In the 3-PLY ARGUER and EXPLAINER, the determination of salience of features for describing precedents takes into account:

1. What are the shared and unshared features between the cfs and the precedent?
2. What are the differences in magnitude of shared features between the cfs and precedent?
3. What features does a counter-example share with the cfs that the precedent does not?
4. Which side do the above features and relative differences favor, plaintiff or defendant?
5. In the precedent, were the above features consistent with the outcome (i.e., was the precedent decided because of the features or in spite of them?)
6. On behalf of which side is the point, response or rebuttal that cites or distinguishes the precedent being made?
7. If the precedent is used as a counter-example, what type? If it is used as a target case for a hypothetical, in what context?

In the ARGUER and EXPLAINER, the determinations of salience are based on express information permanently stored in the dimensions and precedents and dynamically generated in the claim-lattices and argument-records. Items 1 - 3 are determined by comparing the cfs and precedent as more fully described in Chapter 8. The information for deciding items 4 and 5 are contained in the dimensions and the CASE frame of the precedent as described in Chapters 6, 7

and 8. The EXPLAINER provides the side for which a particular point is being made, item 6. The configuration of counter-examples and the cfs determine item 7, the type of counter-example, as described in Chapter 8.

The results of the determinations of salience can be illustrated in the Figures below again by focusing on how the *Data General* case was described in its various roles as precedent:

Citing and Distinguishing: In making points and distinctions, only similarities and differences that support a side's argument are stated. For example, the feature of *Data General* that the disclosures were restricted does not assist making a point for the plaintiff in Figures 42 or 44 because it was not shared by the current fact situation. Therefore, it is not included in the statement of the analogy between the cfs and *Data General*. On the contrary, the fact that the pro-plaintiff feature was not shared is a reason for distinguishing the cfs and *Data General*, which is exactly what the responses do. In Figure 43, on the other hand, the pro-plaintiff feature is shared by the cfs and *Data General* and thus appears in the pro-plaintiff point's statement of analogy. A similar distinction was drawn in the defendant's rebuttal of Figure 45 to show that the *Data General* case, though cited as a pro-plaintiff counter-example, was really not as on point as it might be. Note that when the *Data General* case was cited in the response as a counter-example for the plaintiff, the pro-plaintiff restricted disclosures feature, not shared with the cfs, was not stated.

Citing as Counter-example or Target for Hypothetical: As indicated in the previous example, the use of a precedent as a counter-example also affects how it is described. In citing a precedent as a counter-example, only the similarities and differences that focus on why the precedent is a counter-example are described. In Figure 45, where *Data General* is used as a boundary counter-example, the focus is on the specific feature of which

the precedent is an extreme example: the number of outside disclosees, and the feature is described in terms relative to the *Midland Ross* case to emphasize how much worse *Data General* is even though it was still won by the plaintiff.³ At the bottom of Figure 45 where the *Data General* case is used as a potentially more-on-point counter-example, the emphasis is on the missing ingredient in the cfs that would help plaintiff: restrictions on disclosures. In Figure 46 where *Data General* is cited as a trumping counter-example, the emphasis is on the extra pro-plaintiff feature that it shares with the cfs that the cited case does not: restrictions on disclosures.

In summary, the descriptions of the precedent take advantage of the context of the argument to select which features of the precedent to describe in drawing the analogy and how to describe them.

9.3 Explaining with Case-based Arguments

9.3.1 Explaining by Comparing

One way of explaining with case-based arguments is by comparing the significance of precedents. We have seen above how the legal significance of a precedent depends on the context of the argument and how HYPO's 3-ply arguments for selected precedents demonstrate and compare the significance of various precedents given a particular fact situation. In Chapter 4 we saw that changes in the significance of precedents are demonstrated in HYPO by posing hypotheticals and comparing the resulting arguments. In the *Crown* Extended Example, Section 5.1.7, we saw how such a comparison showed how changed facts made some precedents more significant at the expense of others.

³The corresponding argument-record contains the numbers of disclosees so that the comparison could easily be made more specific.

Signal: How Cited Case Supports Proposition

Accord or [no signal]: directly supports

See: supports

Cf.: analogously supports

Contra: directly supports contrary

But See: supports contrary

But Cf: supports analogous contrary

Figure 40: Citing Cases in an Argument: Citation Signals

9.3.2 *Blue Book* Citations for Summarizing Precedential Support

Another aspect of explaining with case-based arguments is summarizing the overall argument by showing the attorney the precedents that can be cited.

HYPO summarizes the 3-ply arguments with citation displays. **Citation Displays** characterize the degree of support that precedents lend to the proposition that a side should win a claim. They label precedents with “citation signals” that show how strong the precedential support is. In the legal profession, standards have been adopted for the use and interpretation of citations. The most influential standard setter is the “*Blue Book*”, *A Uniform System of Citation*, published by The Harvard Law Review Association. A sampling of standard citation signals and their interpretations are set forth in Figure 40.⁴ Note that the default, no signal at all, indicates that the cited case directly supports the proposition.

HYPO’s “computational equivalents” of the *Blue Book* citation signals are shown in Figure 41. They are defined in terms of HYPO’s various categories of

⁴See [Blue Book, 1986, pages 6 -7]

Signal: Computational Equivalent

Accord or [no signal]: Pro best-case-to-cite, no trumping counter-examples.

See: Pro relevant case, not best-case-to-cite.

Cf.: Pro most-on-point near-miss case.

Contra: Trumping or as-on-point counter-example.

But See: Boundary or less-on-point counter-example.

But Cf.: Potentially more-on-point counter-example.

Figure 41: Citation Signals in HYPO

most-analogous cases and counter-examples.

A cites displays is a skeletal framework for 3-Ply arguments for and against a legal proposition that a side should win a claim. An “Accord” label (and the default of no signal) shows that a precedent strongly supports the proposition. A “See” cite conveys less support. “Contra”, “But See” and “But Cf.” labels are warning signals; they label cases that may seriously affect the reliability of the precedent in supporting the proposition. A “Contra” case is a counter-example that yields just as strong, or stronger support for the opposite side on the proposition. “But See” cases yield some support for the opposite side. “But Cf.” indicates that the listed cases may potentially support the opposite side and should be checked out. The actual 3-Ply arguments play out these relationships among a precedent and its counter-examples.

The citation summaries that introduce the 3-ply arguments of the Extended Examples in Sections 5.1.7, 5.2.5, 5.3.3 and 5.4.3 illustrate some simple citation displays where the “[no signal]” default option indicates that the listed cases directly support the proposition that a party should win the claim (i.e., the cases are the best-cases-to-cite and have no trumping counter-examples). In addition,

HYPO's lists of suggested hypotheticals following the 3-ply arguments use "cf." cites to indicate that they potentially support the proposition.

As summaries of precedential support, Cites Displays have much of the utility of published compilations of citations like those of legal treatises as described in Chapter 3, but Cites Displays are compiled dynamically in light of the cases now in the CKB and tailored to the specific fact situation presented by the attorney. Cites displays also flag the changes in an argument caused by hypothetical changes to the facts. For example, the stronger argument that plaintiff can make in the hypothetical variant of the *Crown* case in Section 5.1.7 is flagged by the changes in the cases citable in the citation summary.

9.4 Conclusion

To summarize what this Chapter has shown:

- HYPO's arguments explicate the significance of precedents, their force in an argument.
- Arguments by analogy to precedents deal with credit assignment. They support a result by assigning credit or blame to similarities or differences among the current fact situation and precedents.
- Potentially, precedents have many interpretations, depending on a variety of factors all of which affect how credit and blame are assigned in the context of a specific fact situation to make or respond to a particular argument.
- HYPO supports flexibly interpreting a single precedent in whatever ways allow it to make a cogent argument given the specifics of the current fact situation and argument context.

It should be noted that if one changes the criteria for evaluating arguments, the significance of precedents naturally will change. One can introduce additional criteria such as:

1. Pedigree and recentness of precedents,
2. Strategic considerations of argument planning, such as the effect of citing a precedent on other aspects of ones argument – other claims, for example.
3. Coherence or consistency criteria, trying to square decisions with the competing rationale that courts say they are applying in precedents, for example, the various principles that courts say the precedents stand for.

These are complexities with which HYPO does not presently deal. HYPO's arguments demonstrate how successfully a program can generate complex legal reasoning in terms of some fairly simple comparisons among precedents. As described in Chapter 12, there are more complex kinds of precedential reasoning, but the models of the more complex reasoning will have to support the same core argument roles for precedents that HYPO does and cannot be successfully implemented without them.

9.5 Figures

==> POINT for PLAINTIFF as Side-1:

WHERE:

EVEN THOUGH:

Plaintiff disclosed its product information to outsiders.

PLAINTIFF should win a claim for TRADE-SECRETS-MISAPPROPRIATION.

CITE: Data General Corp. V. Digital Computer Controls Inc.
357 A.2d 105 (Del. Ch. 1975).

<== RESPONSE for DEFENDANT as Side-2:

Data General Corp. V. Digital Computer Controls Inc. is distinguishable because:

In Crown Industries, Plaintiff disclosed its product information in negotiations with defendant. Not so in Data General.

In Data General, plaintiff's disclosures to outsiders were restricted. Not so in Crown Industries.

==> REBUTTAL for PLAINTIFF as Side-1:

None.

**Figure 42: Citing and Distinguishing *Data General* where
CFS is the *Crown Case***

==> POINT for PLAINTIFF as Side-1:

WHERE:

Plaintiff's disclosures to outsiders were restricted.

EVEN THOUGH:

Plaintiff disclosed its product information to outsiders.

PLAINTIFF should win a claim for TRADE-SECRETS-MISAPPROPRIATION.

CITE: Data General Corp. V. Digital Computer Controls Inc.
357 A.2d 105 (Del. Ch. 1975).

<== RESPONSE for DEFENDANT as Side-2:

Data General Corp. V. Digital Computer Controls Inc. is distinguishable because:

In Crown Industries-Ver1, Plaintiff disclosed its product information in negotiations with defendant. Not so in Data General.

==> REBUTTAL for PLAINTIFF as Side-1:

None.

**Figure 43: Citing and Distinguishing *Data General* where
CFS is Hypothetical Variant of *Crown* Case
with Disclosures Restricted**

==> POINT for PLAINTIFF as Side-1:

WHERE:

PLAINTIFF should win a claim for TRADE-SECRETS-MISAPPROPRIATION.
CITE: Data General Corp. V. Digital Computer Controls Inc.
357 A.2d 105 (Del. Ch. 1975).

<== RESPONSE for DEFENDANT as Side-2:

Data General Corp. V. Digital Computer Controls Inc. is distinguishable because:
In Data General, plaintiff's disclosures to outsiders were restricted. Not so in
Usm-V.-Marson.

In Usm-V.-Marson, plaintiff adopted more security measures than in
Data General.

In Usm-V.-Marson, defendant's access to plaintiff's product
information saved it more time or expense than in Data General.

COUNTER-EXAMPLES:

Pressure Science, Inc. V. Kramer

413 F.Supp. 618 (D. Conn., 1976), is more on point and held for DEFENDANT
where it was also the case that:

Defendant's access to plaintiff's product information saved it time or expense.

Amoco Production Co. V. Lindley

609 P.2d 733, is more on point and held for DEFENDANT

where it was also the case that:

Plaintiff adopted security measures.

Healy, Inc. V. Murphy, Inc.

357 Mass. 728 (1970), is more on point and held for DEFENDANT

where it was also the case that:

Plaintiff adopted security measures.

==> REBUTTAL for PLAINTIFF as Side-1:

Pressure Science, Inc. V. Kramer is distinguishable because:

In Usm-V.-Marson, plaintiff adopted more security measures than in Press Sci V.
Kramer.

NOTE: DEFENDANT's response would be strengthened if:

Plaintiff disclosed its product information in negotiations with defendant.

Plaintiff disclosed its product information to outsiders.

Cf. Crown Industries Inc. V. Kawneer Co.

335 F. Supp. 749 (N.D. Ill., 1971)

[1]

==> POINT for DEFENDANT as Side-1:

WHERE:

Plaintiff disclosed its product information to outsiders.

DEFENDANT should win a claim for
TRADE-SECRETS-MISAPPROPRIATION.

CITE: Midland-Ross Corp. V. Sunbeam Equipment Corp.
316 F. Supp 171 (W.D. Pa., 1970).

<== RESPONSE for PLAINTIFF as Side-2:

Midland-Ross Corp. V. Sunbeam Equipment Corp. is distinguishable because:
In Midland-Ross, plaintiff disclosed its product information to
more outsiders than in Crown Industries

COUNTER-EXAMPLES:

Data General Corp. V. Digital Computer Controls Inc.
357 A.2d 105 (Del. Ch. 1975), held for PLAINTIFF
even though in Data General plaintiff disclosed its product information to more
outsiders than in Midland-Ross Corp. V. Sunbeam Equipment Corp..

==> REBUTTAL for DEFENDANT as Side-1:

Data General Corp. V. Digital Computer Controls Inc. is distinguishable because:
In Crown Industries, Plaintiff disclosed its product information in negotiations
with defendant. Not so in Data General.
In Data General, plaintiff's disclosures to outsiders were restricted. Not so in
Crown Industries.

NOTE:

PLAINTIFF's response would be strengthened if:
Plaintiff's disclosures to outsiders were restricted.
Cf. Data General Corp. V. Digital Computer Controls Inc.
357 A.2d 105 (Del. Ch. 1975)

Figure 45: *Data General* Cited as Boundary and Potentially More-On-Point Counter-Examples in Argument [1], *Crown* Extended Example

[5]

==> POINT for DEFENDANT as Side-1:

WHERE:

Plaintiff disclosed its product information to outsiders.

DEFENDANT should win a claim for
TRADE-SECRETS-MISAPPROPRIATION.

CITE: Midland-Ross Corp. V. Sunbeam Equipment Corp.
316 F. Supp 171 (W.D. Pa., 1970).

<== RESPONSE for PLAINTIFF as Side-2:

Midland-Ross Corp. V. Sunbeam Equipment Corp. is distinguishable because:

In Midland-Ross, plaintiff disclosed its product information to more outsiders
than in Crown Industries-4

COUNTER-EXAMPLES:

Data General Corp. V. Digital Computer Controls Inc.
357 A.2d 105 (Del. Ch. 1975), is more on point and held for PLAINTIFF
where it was also the case that:
Plaintiff's disclosures to outsiders were restricted.

Data General Corp. V. Digital Computer Controls Inc.
357 A.2d 105 (Del. Ch. 1975), held for PLAINTIFF
even though in Data General plaintiff disclosed its product information to more
outsiders than in Midland-Ross Corp. V. Sunbeam Equipment Corp..

==> REBUTTAL for DEFENDANT as Side-1:

None.

**Figure 46: Data General Cited as Trumping and Boundary
Counter-Examples in Argument [1], Crown Ex-
tended Example**

**Hypotheticals to Consider
on Claim of TRADE-SECRETS-MISAPPROPRIATION
in Fact Situation of Crown Industries:**

PLAINTIFF's position would be strengthened in following situations:

SUPPOSE:

**Plaintiff's disclosures to outsiders were restricted.
Cf. Data General Corp. V. Digital Computer Controls Inc.
357 A.2d 105 (Del. Ch. 1975)**

**Figure 47: *Data General* Cited as Target for Hypothetical
Where a New Point Could Be Made. From
*Crown Extended Example***

**3-Ply Arguments for Best Cases to Cite
on Claim of TRADE-SECRETS-MISAPPROPRIATION
in Fact Situation of Data General:**

**On a claim for TRADE-SECRETS-MISAPPROPRIATION,
DEFENDANT can make a stronger argument.
DEFENDANT can cite the following cases
for which there are
no more on point counter-examples:**

**Crown Industries Inc. V. Kawneer Co.
335 F. Supp. 749 (N.D. Ill., 1971)**

**Midland-Ross Corp. V. Yokana
293 F. 2d 411 (3 Cir. 1961)**

**Midland-Ross Corp. V. Sunbeam Equipment Corp.
316 F. Supp 171 (W.D. Pa., 1970)**

**Figure 48: Citation Summary for *Data General* as Current
Fact Situation**

==> POINT for DEFENDANT as Side-1:

WHERE:

Plaintiff disclosed its product information to outsiders.

DEFENDANT should win a claim for
TRADE-SECRETS-MISAPPROPRIATION.

CITE: Midland-Ross Corp. V. Sunbeam Equipment Corp.
316 F. Supp 171 (W.D. Pa., 1970).

<== RESPONSE for PLAINTIFF as Side-2:

Midland-Ross Corp. V. Sunbeam Equipment Corp. is distinguishable because:

In Data General, plaintiff's disclosures to outsiders were restricted. Not
so in Midland-Ross.

==> REBUTTAL for DEFENDANT as Side-1:

None.

Figure 49: 3-Ply Arguments about *Data General* as the CFS

==> POINT for DEFENDANT as Side-1:

WHERE:

Plaintiff disclosed its product information to outsiders.

DEFENDANT , should win a claim for
TRADE-SECRETS-MISAPPROPRIATION.

CITE: Crown Industries Inc. V. Kawneer Co.
335 F. Supp. 749 (N.D. Ill., 1971).

<== RESPONSE for PLAINTIFF as Side-2:

Crown Industries Inc. V. Kawneer Co. is distinguishable because:

In Data General, plaintiff's disclosures to outsiders were restricted. Not so in Crown Industries.

In Crown Industries, Plaintiff disclosed its product information in negotiations with defendant. Not so in Data General.

==> REBUTTAL for DEFENDANT as Side-1:

None.

Figure 50: 3-Ply Arguments about *Data General* as the CFS

CHAPTER 10

Evaluating HYPO's Performance

The HYPO program performs significant tasks of legal reasoning. HYPO manipulates precedents to the same ends as attorneys, and with substantially similar results, to:

1. Make and respond to legal points about a fact situation.
2. Select and highlight the best precedents for each side.
3. Evaluate the strengths of each side's argument.
4. Pose hypotheticals to focus on factual issues important in light of the arguments.

10.1 Comparing HYPO's Points and Responses to Court Opinions

HYPO's facility for reasoning with precedents is demonstrated by comparing HYPO's output to that of real judges and attorneys. Current fact situations based on real legal cases were submitted to HYPO. The 3-Ply Arguments and Hypotheticals posed by HYPO were compared to the points and responses made

in the attorneys' briefs or the judges' opinions for the real cases. The comparisons focused on the following questions:

1. Did HYPO's evaluation of the relative overall strength of the parties' arguments tally with who actually won the case?
2. Did HYPO make points and responses for each side citing the same precedents and in the same way as the precedents were cited in the briefs and opinions?
3. Did HYPO's citation of precedents and posing of hypotheticals raise the same issues as were raised in the briefs and opinions?

Detailed comparisons were undertaken for the following cases:

1. *USM Corp. v. Marson Fastener Corp.* 379 Mass. 90 (1979). HYPO's outputs are shown in the *USM* Extended Example, Section 5.4.3.
2. *Crown Industries, Inc. v. Kawneer Co.* 335 F. Supp. 749 (N.D. Ill., 1971). HYPO's outputs are shown in the *Crown* Extended Example, Section 5.1.7.
3. *Amoco Production Co. v. Lindley* 609 P.2d 733. HYPO's outputs are shown in the *Amexco* Extended Example, Section 5.2.5.
4. *Structural Dynamics Research Corp. v. Engineering Mechanics Research Corp.* 401 F. Supp. 1102 (E.D.Mich., 1975). HYPO's outputs are shown in the *Structural Dynamics* Extended Example, Section 5.3.3.

In the remainder of this section, for each case, HYPO's outputs are compared to the arguments from the courts' opinions or the parties' briefs.

10.1.1 *USM Corp. v. Marson*

The Opinion and Briefs

As indicated by the squib summary of *USM Corp. v. Marson Fastener Corp.* in Section 5.4.1, the case involved a claim by plaintiff USM Corp. that defendant Marson Fastener misappropriated its trade secrets concerning a rivet-making machine. The main issue addressed by the Court in its opinion in the case was whether the plaintiff had taken adequate steps to protect its supposed trade secrets. The Court decided the case in favor of the plaintiff, holding that USM Corp. had taken adequate steps.

Some excerpts of the Court's opinion in the *USM Corp.* case are set forth in Appendix A. The Court justified holding for the plaintiff by analogizing the fact situation to cases that held for the plaintiff like *Space Aero* and *Eastern Marble*. It distinguished cases that held for the defendant like *Motorola, Inc.* and the *Healy* case. The argument in the court's opinion was the culmination of a series of previous arguments in the case. Both plaintiff and defendant had submitted to the judge formal written arguments known as "briefs" which set out a summary description of the facts of the case and the law from each side's viewpoint. In the briefs, the parties justify their positions by citing analogous precedent cases and by distinguishing the opponent's cases. Excerpts from the parties' briefs are presented in Appendices B and C.

The main points and responses drawn from the Court's opinion and the briefs of plaintiff and defendant may be summarized as follows:

1. The Court (and plaintiff) favorably cited the *Space Aero* and *Eastern Marble* cases where plaintiff took adequate measures to protect its trade secrets. In *Eastern Marble* as in *USM*, the plaintiff had undertaken security measures to protect its trade secrets. 379 Mass. at 102, 103.
2. The Court (and plaintiff) distinguished the pro-defendant *Healy* case by

contrasting the precautions taken by USM Corp. with the lack of precautions taken by the plaintiff in that case. 379 Mass. at 102.

3. Defendant distinguished *Eastern Marble* by pointing out that it involved specific nondisclosure agreements between the plaintiff and its employee and cited the *Motorola* case where the court declared that absent specific nondisclosure agreements, the defendant should win.
4. The Court responded by distinguishing *Motorola, Inc.* as involving inadequate security measures, contrasted that case with *Plant Industries* where the security measures were adequate, and cited a counter-example, the *A. H. Emery Co.* case, where detailed drawings and blue prints were protected despite the absence of express warnings about what information was confidential, to show that the absence of warnings did not matter. The Court also cited the *Schulenburg* case for the proposition that blueprints and drawings may be trade secrets. 379 Mass. 100.

HYPO's Citation Summary, 3-Ply Arguments, and Hypotheticals

As the Citation Summary of Section 5.4.3 shows, HYPO also determined that plaintiff had the stronger argument on a claim for breach of trade secrets misappropriation and cited as plaintiff's most supportive cases, (i.e., best cases to cite with no trumping counter-examples) two cases that the Court had relied on: *Space Aero* and *Plant Industries*. The other case HYPO cited, *Peggy Lawton Kitchens*, was decided in 1984 and was not in existence when the *USM* case opinion was written.

A comparison of HYPO's selections of analogous precedents in Figures 31 and 32 of Chapter 8 and the cases cited in the Court's opinion shows the following results:

1. Of the nine cases HYPO, after its own analysis of the fact situation, selected as plaintiff's best cases to cite, seven of the cases had actually been cited by the Court as supporting the plaintiff's side. Of the other two cases, one

was the more recent *Kitchens* case and the other was a hypothetical fact situation in HYPO's CKB.

2. Of the three cases HYPO chose as defendant's most on point cases, one was the *Healy* case which the Court distinguished, one was decided subsequent to the date of the *USM* decision and the last was not mentioned by the Court.
3. With respect to the merits of the trade secrets misappropriation claim, the Court cited or distinguished thirty-one cases that HYPO did not cite because none of the cases are in the CKB. Of the ten cases in HYPO's CKB that were either cited or distinguished by the Court, HYPO selected nine of them as most on point or best cases. HYPO treated only one, the *Structural Dynamics* case, as irrelevant to the fact situation. Of five cases¹ not cited by the Court but which HYPO treated as important (i.e., most on point or best case to cite), the *Amoco* case postdated the *USM* decision.

Comparison with the HYPO-generated 3-ply arguments for the case in Section 5.4.3 shows that HYPO hit the major points and responses. In the indicated 3-Ply arguments, HYPO cited or distinguished the following cases in very similar ways to the court:

1. In Arguments [6] and [7], HYPO cited the *Space Aero* and *Eastern Marble* cases for the plaintiff drawing the analogy to the fact that plaintiffs adopted security measures in each. In responding to *Eastern Marble*, by posing *Healy* as an as-on-point counter-example, HYPO evidenced the same juxtaposition of conflicting precedents that the real arguers and the Court focused on. HYPO also distinguished the *Eastern Marble* case in the same way as the defendant did – by focusing on the nondisclosure agreement between plaintiff and defendant in that case.

¹The five include *Telex*, *Kewanee*, *Analogic*, *Amoco* and *Pressure Science*.

2. In Arguments [6] and [8], HYPO distinguished the *Healy* case in the same way that the Court did, by pointing out that the plaintiff in *USM* took more security measures than in *Healy*. In addition, HYPO suggests a way of distinguishing *Healy* that the Court did not think of by focusing on the competitive advantage gained by the defendant in *USM*.
3. As shown in Argument [9], HYPO distinguished the *Motorola* case from the *Eastern Marble* case in the same way that the Court did – by focusing on the greater security measures taken in the latter. Argument [9] was generated with *Eastern Marble* as the current fact situation.

10.1.2 *Crown v. Kawneer*

HYPO's behavior also comports well with the way courts analyzed and decided the case of *Crown Industries, Inc. v. Kawneer Co.* and similar cases. The fact situation of *Crown* is described in Section 5.1.1. The Court held in favor of the defendant, *Kawneer*, where the plaintiff had made disclosures of its supposed trade secrets to various outsiders.

Court Opinions

The quotations below indicate how the Court in *Crown* and in two other cases raising similar issues made arguments citing or distinguishing the nearly identical *Midland-Ross* and *Yokana* cases. This is how the Court analyzed the *Crown* case in its opinion:

Even though the Plaintiff's power packs, exemplified by PX-121, might have had to be rendered inoperative and examined by an engineer in order to discover the alleged trade secrets contained therein, the sale of the power packs nevertheless constituted a public disclosure which

defeats a claim founded upon alleged misappropriation of the trade secrets allegedly contained in the power packs. *Midland-Ross Corp. v. Sunbeam Equipment Co.*, 316 F. Supp. 171, 177 (W.D.Pa. 1970), affirmed, 435 F.2d 159 (3d Cir. 1970). 335 F. Supp. at 761.

No confidential relationship existed between the Plaintiff, Crown, and the Defendant, Kawneer, because Plaintiff never requested Defendant to keep the nature or details of Plaintiff's power pack in confidence; nor was the relationship between Plaintiff and Defendant of the type from which such a confidential relationship could be implied. 335 F. Supp. at 762.

In another case with similar issues, *National Rejectors, Inc. v. Trieman* 409 S.W.2d 1, 40-42 (Sup. Ct. Mo., 1966), the Court said:

[W]e do find some significant parallels between the facts of this case and those of *Midland-Ross Corporation v. Yokana* (D.C. N.J.), 185 F.Supp. 594 [The *Yokana* case involved the same plaintiff as *Midland-Ross Corp. v. Sunbeam Equipment Co.* and the same defense that plaintiff had disclosed its secrets to outsiders]... Thus the claim of trade secrets by National and by plaintiff in *Midland-Ross* have essentially the same basis. ... What was lacking in *Yokana* as in this case, was any evidence that, prior to defendant's competition, plaintiff considered the information which *Yokana* sought to use trade secrets. The court pointed out that plaintiff's blueprints in *Midland-Ross* were furnished plaintiff's suppliers and customers and potential customers. The court found an absence of precautions on the part of plaintiff to keep secret information regarding its machines.

Although the following cases do not parallel the present case as closely as *Yokana* our conclusion here is consistent with that reached in: [citing and describing other cases.]

Not only are the facts of *Midland-Ross Corporation v. Yokana* comparable to those in this situation, but we find the relief afforded in that case also appropriate in this....

In *Mixing Equipment Co. v. Philadelphia Gear, Inc.*, 436 F.2d 1308, 1315 (3d Cir., 1971), also a case with issues similar to *Crown*, the court distinguished the *Yokana* case as follows:

[Another case] and *Midland-Ross Corp. v. Yokana*, 293 F. 2d 411 (3 Cir. 1961) cited by appellants are inapposite. They involve situations in which restrictive covenants had not been utilized by the former employer.

HYPO's Citation Summary, 3-Ply Arguments, and Hypotheticals

HYPO's outputs for the *Crown* case are shown in Section 5.1.7.

Like the Court, HYPO determined that the Defendant had the stronger argument. In its selection of the *Midland-Ross* and *Yokana* cases as among defendant's best cases to cite, HYPO agreed with what the Courts actually did in the *Crown* case and the other cases. HYPO's analysis of the current fact situation – by comparing and contrasting it with the most analogous cases – is similar to that actually performed by the Courts and, in particular, the points in Arguments [1] and [2] show that HYPO draws the same analogy as the Courts did. In both arguments, HYPO's distinction between the *Data General* case and the current fact situation is the obverse of the Court's distinction, quoted above, between the *Yokana* case and the fact situation in *Mixing Equipment*.

Arguments [3] and [4] show that, like the Courts, HYPO also addresses the issue of Crown's having disclosed its information to the defendant without having secured a confidentiality agreement. Note how the suggested hypotheticals focus on how Crown's argument would be improved if the plaintiff and defendant had entered into a nondisclosure agreement.

10.1.3 *Amoco Production Co. v. Lindley*

In several important respects, HYPO's analysis of the *Amexco* fact situation of Chapter 3 compares favorably with that of the Court in the the real case of *Amoco Production Co. v. Lindley*, 609 P2d 733 (Okla., 1980) upon which the

case was based.²

The Court's Opinion

A description of the *Amoco Production* case is set forth in Appendix G. The Court held for the defendant Lindley where Lindley was the sole developer of the Lindley system, a program to analyze oil well probe information, and although Lindley had entered into a nondisclosure agreement, the agreement did not specifically refer to the Lindley system. The Court said:

[Other] user manuals [of the plaintiff] were stamped confidential, numbered, and controlled centrally by management. This was not true of the Lindley System. Trade secret status is difficult to establish and often entails establishing that affirmative and elaborate steps were taken to insure that the secret claimed would remain so. *Telex Corp. v. International Business Machines Corp.*, 367 F. Supp. 258 (N.D.Okl. 1973), rev'd on other grounds, 510 F.2d 894 (10th Cir. 1975) 609 P.2d at 743.

In *Structural Dynamics Res. Corp. v. Engineering Mechanics Res. Corp.*, 401 F. Supp. 1102 (E.D. Mich. 1975), the Court dealt with charges against three former employees of Structural Dynamics Research Corp. [S.D.R.C.] for unfair competition, misappropriation, and misuse of confidential trade secret material and breach of contractual duty not to disclose confidential information. . . . This language [of the S.D.R.C. contract with its employees] was embracive enough to cover the subsequent actions of defendants in setting up a business using a computer system very similar to the one they had created for their former employer. The language of the Amoco employment contract is not so comprehensive. 609 P.2d at 744, 745.

²In all material respects, the *Amezco* fact situation of Chapter 3 and Section 5.2.5 closely tracks that of the *Amoco Production* case. New names for the parties and products were substituted.

HYPO's Citation Summary, 3-Ply Arguments, and Hypotheticals

HYPO's Citation Summary for the *Amoco* case is shown in Figure 51. Although HYPO determined that the plaintiff had a stronger argument – the Court held for defendant – like the Court, HYPO treated the *Structural Dynamics* case as one of plaintiff's strongest cases to cite.³

3-Ply Arguments for Best Cases to Cite
on Claim of TRADE-SECRETS-MISAPPROPRIATION
in Fact Situation of Amoco:

On a claim for TRADE-SECRETS-MISAPPROPRIATION,
PLAINTIFF can make a stronger argument.
PLAINTIFF can cite the following cases
for which there are
no more on point counter-examples:

Structural Dynamics Research Corp. V. Engineering Mechanics Research Corp.
401 F. Supp. 1102 (E.D.Mich., 1975)

Eastern Marble Products Corp. V. Roman Marble, Inc.
364 N.E.2d 799 (Mass. 1977)

Figure 51: HYPO's Citation Summary for *Amoco*.

The 3-Ply Arguments and hypotheticals that HYPO made for the *Amoco* case are similar to those shown for the *Amexco* fact situation in Section 5.2.5. Comparison of Argument [2] with above-quoted language shows that HYPO dis-

³HYPO's outputs for the *Amexco* fact situation are shown in Section 5.2.5. There HYPO determined that both sides in the *Amexco* situation had a strong argument of a claim for trade secrets misappropriation. HYPO did so because it cited the *Amoco* case for the plaintiff. That, of course, was not an option for the Court that decided the *Amoco* case.

tinguished *Structural Dynamics* for the defendant in the same way that the Court did, by pointing out the difference in the specificity of the agreements. In the absence of a trumping counter-example, the Court gave greater weight to that distinction than HYPO did. Argument [5] shows, however, that HYPO analyzed the issue of the employee's having been sole developer of the trade secrets in the same way that the Court did. Note how HYPO responded to citation of the *Wexler* case by focusing on the fact that there was a nondisclosure agreement in *Amerxxco*, a distinction that made *Structural Dynamics* into a pro-plaintiff counter-example.

Argument [1] shows that HYPO focused, as the Court did, on the issue of how many security measures the plaintiff took. HYPO distinguished the *Eastern Marble* case by pointing out that plaintiff there took more precautions than in *Amerxxco*.

HYPO's citations of cases, particularly the suggested targets for hypotheticals, including the *Telex* case, are used in much the same way that the Court used them to guide the inquiry as to what facts to look for and how to legally evaluate them. The Court in the *Amoco* case did not decide the merits of the trade secrets claim, but, instead, sent the case back to the trial court for further action. In effect, the Court's citing cases like *Telex* and *Structural Dynamics* was to instruct the lower court as to what factual findings would be significant.

10.1.4 *Structural Dynamics v. Engineering Mechanics*

The Court's Opinion

The *Structural Dynamics* case is summarized in Section 5.3.1. The Court addressed both claims for breach of a nondisclosure agreement and for trade secrets misappropriation. It held in favor of the plaintiff's claim for breach of the nondisclosure agreement. The Court indicated, however, that, since the defendant

employees were the sole developers of the trade secret information, it would have held against plaintiff's trade secrets claim except for the fact that the employees had also entered into an agreement not to disclose confidential information to outsiders. The Court said:

In this case Surana and Kothawala [the defendant employees] did not obtain the claimed trade secrets through improper means. In substantial measure they were the developers and innovators... In such a case, absent an express contractual obligation by the employee not to use or disclose such confidential information acquired during his employment adverse to his employer's interest, he is free to use or disclose it in subsequent employment activity.

In *Wexler v. Greenberg*, 399 Pa. 569, 160 A.2d 430 (1960), the Pennsylvania Supreme Court held that in the absence of a contractual obligation not to use or disclose, no duty arose from the employment relationship itself that would prevent a chemist from using and disclosing secret chemical formulae developed by him in the course of his former employment. The court distinguished the cases in which an employer discloses to his employee a pre-existing trade secret from those in which the employee himself develops the trade secret sought to be protected. 101 F. Supp. at 1111,2.

A quantity of documents belonging to SDRC were also found in possession of defendants when this action was commenced. 101 F. Supp. at 1116.

Although SDRC did not use the ultimate in policing measures, the professional calibre of its employees, and the nature of its development work made heavy-handed measures unnecessary. Moreover, the confidential nature of development work was specifically called to each employee's attention in his individual confidential disclosure agreement. 101 F. Supp. at 1117.

HYPO's Citation Summary, 3-Ply Arguments, and Hypotheticals

Like the Court, HYPO treated the fact situation as raising claims both for breach of a nondisclosure agreement and trade secrets misappropriation. On the claim for trade secrets misappropriation, HYPO determined that both sides could

make strong arguments. On the claim of breach of a nondisclosure agreement, HYPO came to the same conclusion as the court that the plaintiff had the stronger argument.

Although the cases that HYPO relied on post-dated the *Structural Dynamics* case, examination of HYPO's points in Arguments [1] and [2] show that HYPO focused on the same issues important to the court, the facts that plaintiff and defendant entered into nondisclosure agreements, that the defendants were the sole developers of the trade secrets, and that the employees brought various product development tools with them from the plaintiff.

Argument [3] shows that HYPO distinguishes the *Wezler* case just like the Court did, by focusing on the fact that there, the employee had not entered into a nondisclosure agreement.

10.2 Comparing HYPO's Citation Displays to Treatise Notes

HYPO's Citation Summaries, 3-Ply Arguments and Suggested Hypotheticals compare favorably with the compilations of footnotes in legal treatises. Figure 52 shows cases cited in various footnotes having to do with the effect of disclosures to outsiders. HYPO's outputs for the *Crown* case, Section 5.1.7 have much of the utility for helping an attorney to plan an argument that the compilations of citations in the Treatise footnotes have. The difference is that whereas an attorney needs to find the right treatise footnotes manually, HYPO generates the compilation dynamically and automatically from its analysis of the cfs.

10.3 Discussion

The evaluation shows that HYPO is a promising prototype of an automated "Brief Writers' Assistant." Attorneys need to find precedents and to organize them into arguments about a fact situation and that is what HYPO does. Although HYPO's judgments about the overall strength of an argument do not always coincide with the Courts' ultimate decisions, nevertheless, HYPO:

- Treats as significant many of the same precedents that the courts do.
- Demonstrates both sides of an argument based on the precedents.
- Distinguishes and cites counter-examples to the precedents in the same way as the courts.

Empirical experiments are planned to provide a more detailed benchmark of HYPO's performance, and in particular to confirm what we know in an informal way, that HYPO's argument moves and hypotheticals impress attorneys as reasonable from a legal viewpoint and as helpful pointers to useful precedents organized according to their utility in arguments. In one experiment, modeled on the MYCIN evaluation, [Yu *et al.*, 1984], subjects comprising lawyers and law students will be provided with a hypothetical fact situation and the same cases that HYPO has in its CKB. They will be asked to select the cases that they would be sure to cite in favor of each side in the fact situation. For the cases they select, they will also be asked to briefly outline a point citing the case for a side, a response to the point on behalf of the opponent and a rebuttal. In a blind test, legal experts will be provided the subject's outputs as well as HYPO's selections of cases and 3-Ply Arguments and asked to rank them according to acceptability. The experiment will show whether HYPO performs the tasks of selecting and organizing precedents for arguments on a par with the subjects.

As the size and scope of HYPO's Case Knowledge Base expands, it will be possible to compare its performance to those of existing full text retrieval systems like LEXIS and WESTLAW in so far as the quality of the assistance they give to attorneys who need to make arguments about specific fact situations.

Legal Proposition: When a product is marketed, put on display or advertised in such a manner as to allow its secret to be known, the "secret" is lost.

Authorities:

- Crown Industries, Inc. v. Kawneer Co.*, 335 F. Supp. 749, 761 (N.D.Ill. 1971) (sale terminates trade secret status even if product would have to be rendered inoperative and disassembled by an engineer, i.e., if product which can be readily reverse-engineered is sold, secrecy is lost);
- Midland-Ross Corp. v. Sunbeam Equipment Corp.*, 316 F. Supp. 171 (W.D. Pa.) *aff'd*, 435 F.2d 159 (3d Cir. 1970) (disclosure of trade secret by reason of operating instructions provided to customers);
- Speedry Chems. & Prods., Inc. v. Carter's Ink Co.*, 306 F.2d 328, 334 (2d Cir. 1962);
- Cf. Telex Corp. v. IBM*, 367 F. Supp. 258, 358 (N.D. Okla. 1973), *antitrust aspects rev'd, trade secret aspects aff'd although computation of damages modified*, 510 F. 2d 894, (10th Cir. 1975) (although some of IBM's trade secrets lost through IBM's marketing products, Telex's pervasive, willful trade secret misappropriation grounds for injunctive relief designed to limit further misappropriation);
- But cf. Data Gen. Corp. v. Digital Computer Controls, Inc.*, 357 A. 2d 105 (Del. Ch. 1975) (despite arguably broad distribution of maintenance manual – restrictively legended – from which defendant copied plaintiff's minicomputer circuitry, court found (a) trade secret continued and (b) an absence of independent development by defendant.);

Figure 52: Sample Compilation of Citations: Excerpts from three footnotes, citing more than 100 cases, in the legal treatise, *Milgrim on Trade Secrets*, Volume 12, Section 2.05[2], nn. 8–10.

CHAPTER 11

Implementation of HYPO

Chapter 4 provides a detailed account of HYPO's architecture, modules, data structures and algorithms. In this chapter we briefly examine some lower level features of HYPO's implementation including the programming environment and flavor system modifications.

11.1 Programming Environment

The HYPO program runs on a Texas Instruments Explorer and is written in Zetalisp. It comprises approximately 3500 blocks of VAX storage which includes both source code and a compiled version of the program. It takes approximately 20 minutes to load the program.

HYPO takes from 2 to 4 minutes to generate a complete set of 3-ply arguments and suggestions for hypotheticals from a fact situation already represented in legal-case-frames. The approximate times for generating 3-ply arguments and hypotheticals for the fact situations of the Extended Examples, Chapter 5 are shown below:

Structural Dynamics 132 seconds

Amexco 183 seconds

Crown 199 seconds

USM 278 seconds

These times include the input/output delays for making three or four menu selections and writing the files of outputs. The longer processing times for some cases reflect the fact that for those fact situations, there are multiple best cases to cite for a side, each one of which is the subject of a separate 3-ply argument.

11.2 Flavor System Modifications

The HYPO program makes extensive use of the flavor facilities available in Zetalisp. As described in Chapters 4 and 6, HYPO's language for representing and analyzing cases is implemented in flavors. The legal-case-frames, interpretation-frames, case-analysis-records, argument-records, claim-lattice nodes and dimensions are all defined as flavors.

HYPO's flavors are specially modified to deal with three implementation problems frequently encountered in frame-based representation schemes employing flavors:

1. Keeping track of flavor instances.
2. Cross-referencing flavor instances.
3. "Copying" flavor instances.

The modifications are contained in four mixins that make up HYPO's flavors:

1. Self-cataloging

2. Self-naming
3. Post-processing
4. Dumping

Keeping Track: The self-cataloging mixin facilitates keeping track of flavor instances. Instances with the self-cataloging mixin are automatically cataloged upon instantiation in each of their target catalogs. There are two main catalogs, the **global-catalog** and the **post-process-catalog**. The **global-catalog** contains all of the instances generated in a session with HYPO or their replacements. As described in Chapters 4 and 6, it is used as a data base for storing and retrieving information about cases in the Case Knowledge Base. The use of the **post-process-catalog** is described below.

Cross-referencing: Most hypo flavor instances cross-reference other flavor instances, that is, the values of some of their slots are other flavor instances. For example, the value of the *:case* slot of each legal-case-frame associated with a given legal case is the top-level CASE frame for that legal case. The self-naming and post-processing mixins facilitate cross-referencing. By virtue of the self-naming mixin, the value of the string in the instance's *:name* slot is set equal to the instance itself. Any instance with the post-processing mixin gets cataloged automatically in the **post-processing-catalog**.

The utility of the cross-referencing feature is apparent when the HYPO program is loaded. Each legal case has a corresponding file of make-instance forms for its various legal-case-frames. When the file is loaded, the make-instances are evaluated and the legal-case-frames are instantiated, their names are set to themselves and they are cataloged in the **global-catalog** and **post-processing-catalog**. At that point, their various slots refer to the *names* of other instances rather than to the instances themselves. A call to the post-processing function replaces the names with the instances. It runs through each of the objects in the

post-processing-catalog and for each of the slots listed in the object's **:postp-list**, it replaces the name of any instance in that slot with the instance itself.

Copying: Instances are copied through the use of the dumping mixin. Instances with the dumping mixin can be "dumped" into files in the sense that make-instance forms are created that can be written to the file. When those make-instances are re-evaluated, they create "copies" of the same instances. As described in Chapters 4 and 8, copying cases is useful in creating hypothetical variants of a seed case. A copy of a seed case is made by dumping it into a file, in the process of which the modifications are inserted. The make-instances for the variant are then re-evaluated, automatically cataloged and post-processed. Copying is also useful in permanently storing hypothetical cases generated by HYPO in the course of a session. It is not possible to store the actual instances in a file except in the sense that make-instance forms for the newly created instances are dumped into a file from which they can be "reconstituted".

CHAPTER 12

Extending the HYPO Research

In this chapter, we discuss briefly how to extend the methodology of the dissertation research in four ways to build an extension of HYPO (“Extended HYPO” or “HYPO-XL”) that could perform the following tasks:

1. Reason with abstract legal predicates.
2. Argue by analogy from other kinds of claims.
3. Connect with existing legal databases.
4. Learn dimensions.

12.1 Reasoning with Abstract Legal Predicates

Statutes and other express rules from constitutions and regulations, court-made rules for deciding claims, and general principles propounded by courts as decisional guides can be seen as partial theories of a legal domain. They employ abstract theoretical terms – legal predicates like “reasonable time”, “ordinary care” or “substantial non-infringing use”. The theories are partial in the sense that the predicates are not adequately defined to enable deductively inferring

whether they apply to a fact situation and there may be disagreements among courts as to which theories to apply, how to formulate the theories and what they mean.

Eventhough the express legal rules are not well defined, attorneys employ them as theoretical justifications why a fact situation should be decided in a particular way. To suggest what a theoretical justification might look like in the context of a now familiar example, consider how HYPO-XL might reformulate the point and response in Argument [1] of the *Crown* Extended Example, Section 5.1.7:

↪ For *Side-1*, the defendant, HYPO-XL would cite *Midland-Ross* for the proposition that, after disclosing its information to outsiders, plaintiff Crown could no longer satisfy the “Secrecy” element of a trade secrets misappropriation claim.

↪ The response for the plaintiff as *Side-2* would be (In the spirit of “I *am* a teenager!” ...): Plaintiff Crown does not need to satisfy any Secrecy element. Crown has as much of a secret after disclosing its confidential information to just five people as the plaintiff in *Data General* had after disclosing its information to 6000 people.

In this example, the more abstract legal predicate at the focus of the dispute is Secrecy. As discussed in Chapter 3, although there is disagreement as to what the elements of a trade secrets claim are, there is no dearth of court opinions or legal treatises that purport to define a trade secret. Secrecy is on almost everybody’s list of elements, although usually the authorities do not purport to define Secrecy beyond making the generally unhelpful distinction between “absolute” and “relative” secrecy. See [Milgrim, 1985] and [Nimmer, 1985]. In any event, HYPO-XL’s argument on behalf of *Side-2* is that 6000 is such a large number of disclosees that the court in *Data General*, in effect, has waived, or at least weakened, any requirement of Secrecy.

HYPO's current vocabulary of abstract legal predicates is very limited comprising basically only the legal claims with which it deals: trade secrets misappropriation and breach of contract, especially breach of nondisclosure and non-competition agreements.

Extending HYPO's vocabulary of abstract legal predicates entails dealing with a difficult problem: the predicates are not well-defined. Just as with HYPO's claims, the theoretical concepts employed in express legal rules have no definitions sufficient to deduce whether the terms apply to a fact situation or not. The meanings of the abstract terms, like the meanings of claims, come from the cases, in particular from the holdings of courts as to whether the term was satisfied in a given fact situation, and the methods for analogizing from one fact situation to another. Thus, an attorney will need to cite cases to support an assertion that a particular legal predicate is satisfied, just as he would to support an assertion that a particular party should win a claim. In addition, the methods of response – distinguishing and citing counter-examples – still apply.

This suggests that the same approach could be employed to represent meanings of theoretical terminology as has been used in HYPO to represent the meanings of claims. HYPO uses cases to scope out the boundaries of what fact situations have or have not been deemed to present winning trade secrets claims. An Extended HYPO would also tag certain important predicates with cases that scope out the boundaries of fact situations that have or have not been deemed to satisfy the predicate. Just as dimensions in HYPO represent factors that affect claims, in an Extended HYPO, dimensions would represent factors that affect other legal predicates like the elements of claims. Cases where courts held that a particular predicate was or was not satisfied would be indexed both by the predicate and by the dimensions along which they are stronger and weaker examples of the predicate.

There would still be some difficult problems to solve before an Extended

HYPO could reason effectively with more abstract legal predicates:

1. Selecting the right predicates.
2. Representing the theoretical analysis performed by the court in a precedent.
3. Supporting multiple theoretical analyses of a precedent.
4. Dealing with interactions among factors.
5. Dealing with the logic of the predicates.

Selection: If one is to represent more abstract legal terminology, one must choose which theoretical terms to represent. This may be quite controversial in dealing with court-made rules. Substantially different formulations of a rule may appear in different opinions or even in the same opinion.

Augmenting Case Representation: HYPO's representation of how a case is decided will need to be augmented to reflect the court's theoretical analysis or rationale for deciding the case. The predicates applied by the court and its holding as to whether a predicate is satisfied will have to be identified. This also is not uncontroversial. Courts may not state clearly what issues they are deciding, what the criteria for decision are, or how they decided the issue. Thus the process of entering cases into the CKB will require considerably more interpretation.

Multiple Interpretations: To be faithful to the way legal argument is performed, an extension of HYPO should deal with at least some of the alternative theoretical formulations of the domain. Different statutes or rules may apply to a given fact situation with contradictory outcomes. Thus, in addition to representing the rationale that the court did apply in a precedent, it is also necessary to represent at least some of the alternative rationales that it could have applied.

Interactions among Factors: As one starts to deal with theoretical components of claims, one will not be able to avoid dealing with the theoretical interactions among the factors. Facts that are strengths for one component of a claim may be weaknesses for another. Although this problem exists for HYPO now, it is ameliorated by HYPO's focus on claims. The potentially complex detailed interactions among factors tend to be lumped together in the Court's final decision of the claim. Although facts that are strengths for one *claim* may be weaknesses for another claim, HYPO's criteria for evaluating arguments do not take those more complex strategic interactions into account. Since a legal claim is a basic and important unit – lawyers tend to consider individual claims independently even though they also care about the overall lawsuit – this oversimplification has not posed major problems.

Logic of the Predicates: Another complication is the logical interaction among the predicates. Although the predicates are not well enough defined to allow one to deduce whether they apply or not, they are defined to some extent if only by their common non-technical usage. Arguments that describe precedents in terms of abstract theoretical predicates will thus have to deal with avoiding or exploiting apparent inconsistencies in terms.

Despite the problems, the use of cases to represent the meanings of abstract legal predicates is clearly an important beginning. A dimensional structure will be effective in ordering the cases to which a predicate has been held to apply or not. For example, although arguing about the meanings of predicates is beyond HYPO's present capabilities, HYPO does know that *Data General* is an extreme case for the plaintiff in some sense. It is a *boundary* case for plaintiff along the *Secrets-Disclosed-Outsiders* dimension, the weakest case along the dimension that the plaintiff still won. By linking the legal predicate, the Secrecy element, to the dimension, an Extended HYPO would know that such a move along the dimension "stretches" the meaning of Secrecy to an extreme. At the same time,

like a real attorney, HYPO-XL must be able to make alternative interpretations of a precedent that favor an opponent. For example, it should be able to point out that there is an alternative explanation of *Data General* in which the requirement of Secrecy is preserved, namely that the court held that the Secrecy element was satisfied by the fact that all of the disclosures were subject to confidentiality restrictions.

12.2 Arguing by Analogy from Other Kinds of Claims

A somewhat simpler extension of HYPO's adversarial, case-based methodology would be to get HYPO to argue by analogy from other kinds of claims.

When in searching for precedents that support a client's position, a lawyer cannot find any that deal with the same claim, he may resort to cases dealing with similar fact situations in other claims. In effect, he relaxes the criteria of what constitutes an analogous case to accept cases that at least favor the right side in similar circumstances, even if not under the right rubric. Courts actually do apply cases from one kind of claim to another. For example, in deciding in favor of the defendant Sony on the *copyright* claim in *Sony Corp. v. Universal City Studios*, 464 U.S. 417,456 (1984) (See Chapter 3), the Supreme Court cited *patent* cases that raised the same factual issue of the existence of a substantial noninfringing use.

An Extended HYPO could import arguments from one claim to another by looking for analogous cases to cite for a side in claim-lattices for other claims that it constructs for a current fact situation. For example, in Argument [5] of the *Crown* Extended Example, Section 5.1.7, HYPO-XL could respond to citation of the *Data General* case, cited on a claim for trade secrets misappropriation, in a way that would be appropriate for a contracts claim. It could raise the issue of

whether the outsider's contractual obligations not to disclose the secrets could be enforced where there is no evidence that the contracts were supported by consideration. If the nondisclosure agreements between plaintiff and its outside disclosees are not enforceable, then plaintiff has failed adequately to protect its secrets.

There are two key elements to this kind of reasoning:

1. HYPO-XL's failure to make an argument response drives it to consider cases from different domains that are farther afield.
2. HYPO-XL must appropriately relax the criteria of analogy to unearth cases that are still useful for the argument.

For example, in its attempt to find a way to respond to the point citing the *Data General* case in Argument [5] on behalf of defendant as *Side 2*, the 3-PLY ARGUER would be frustrated because there are no more on point counter-examples in the claim-lattice. As a result HYPO-XL would check lattices dealing with other claims. Since the current fact situation involves an *agreement* between plaintiff and disclosees to keep the disclosures confidential, HYPO-XL would also construct around the cfs a claim-lattice for a *contracts* claim. It would determine that there is a pro- Δ *contracts* most-on-point case, *Dougherty v. Salt* (227 N.Y. 200 (1919)), which held against the party trying to enforce the contract where the other party received nothing of value for entering into the agreement (i.e., the contract was held to be unenforceable for lack of consideration). Since there is no information in the problem situation that the disclosees received any consideration either, HYPO-XL would cite the *Dougherty* case in response. In this example, relaxing the criteria of analogy meant treating a weakness in a hypothetical *contracts* claim of plaintiff against its disclosees as a weakness of plaintiff's trade secrets claim against the defendant.

There is no guaranty that such a response, imported from another claim, will be meaningful. But as a general heuristic, when the underlying facts of cases are similar, so are the legal considerations despite the difference in formal claims. For example, the non-enforceability of non-disclosure agreements is suggested as a threat to protecting trade secrets in [Gilburne & Johnston, 1982, p. 231].

12.3 Connecting with Legal Databases

HYPO presents the possibility of a considerable advance over current means of access to the existing legal databases, LEXIS and WESTLAW, which now require cumbersome key word searches and whose ranking of returned cases is based on statistical criteria that do not adequately capture the relevance of the cases to the attorney user's inquiry. The fact that HYPO performs sophisticated argument tasks using a simple dimensional scheme for representing and reasoning about the argument significance of case features suggests that its basic mechanisms of case-based reasoning could also be used to order cases returned by database queries more intelligently in terms of their real relevance to an attorney's problem.

A simple link between the current version of HYPO and these databases would allow an attorney to conduct research in the following way. The attorney would describe his fact situation to the program. HYPO would conduct its analysis, retrieve cases from its CKB and present them to the attorney in the form of 3-ply arguments and claim-lattices as described above. If the attorney wanted to examine the text of the cases, he would be able to retrieve them on the basis of the citation information contained in the HYPO version of the case. As described in Chapter 6, the top-level case frames of cases in the CKB contain the citation to where the actual text of the opinions may be found. With that information, a LEXIS or WESTLAW search could be conducted on the citation fields of cases in their case databases. Thus, the attorney could have before him not only HYPO's

summary of the cases and how they may be used, but the full text of the actual decision.

A more sophisticated link between an Extended HYPO and these databases offers the promise of making available their enormous databases of cases. An Extended HYPO program could be used to help prune the cases returned by a LEXIS or WESTLAW search so that only the best cases (in HYPO's more intelligent sense of "best") are presented first to the attorney. Since it is unlikely that one can restructure the way cases are represented in LEXIS or WESTLAW, this would entail being able to re-express the thousand or so cases returned by LEXIS or WESTLAW in a HYPO-type representation scheme, a sophisticated natural language problem. The problem may be simplified somewhat by the fact that WEST's key numbering scheme with its abstracts of the cases are also on line. Those abstracts and the key numbering scheme correspond, to some extent, to HYPO's dimensions, offering the possibility of filling out a legal-case-frame representation from the abstracts. An Extended HYPO could then select the most on point or troublesome cases to present to the attorney.

12.4 Learning Dimensions

Of the variety of learning tasks that an Extended HYPO might perform, the hardest and most important is learning new dimensions. Two cornerstones of the current HYPO program will be very important for that difficult task: comparing arguments and posing hypotheticals.

An Extended HYPO would determine that it needs to learn a new dimension by comparing the best arguments it can make about a case with the actual decision of the court. If HYPO-XL's strongest arguments favored one side, but the court decided in favor of the other side, that would present an anomaly indicat-

ing the need to learn something new. For example, if the *Outsider-Disclosures-Restricted* dimension had been unknown at the time *Data General* was entered into the CKB, the circumstance that plaintiff won the case despite the fact that HYPO-XL could only make pro-defendant arguments is an anomaly. It would alert a learning module to the need to acquire knowledge of a yet unknown, pro-plaintiff dimension associated with *Data General*. Actually, such an anomaly would have a number of possible explanations:

1. The case may present factors unknown to HYPO-XL's then current library of dimensions. These factors would be the basis of new dimensions.
2. The court may not have resolved conflicting features in the same way that HYPO-XL did.
3. The court may have applied argument evaluation criteria that were different from HYPO-XL's.

Deciding which possible explanation applies is a hard problem of credit assignment.

An Extended HYPO's ability to pose hypothetical test cases would be essential for testing what the correct resolution of the anomaly should be. Although the credit assignment problem is extremely difficult, it is unthinkable to try to address it without the ability to pose hypotheticals to eliminate possible explanations. That is, of course, why the Justices employ hypotheticals – to help them deal with their credit assignment problem – and why the HYPO research is significant for machine learning and its need more effectively to generate test cases.

CHAPTER 13

Conclusion

This dissertation has shown how a computer program can generate sophisticated, realistic arguments by reasoning about concepts whose meanings are not defined logically by rules but represented analogically with prior cases in which the concepts were applied. The HYPO program reasons adversarially about problem situations in a legal domain by comparing them with real precedent cases in its Case Knowledge Base and with realistic hypothetical cases that it makes up.

The dissertation describes, and the HYPO program implements, an adversarial, case-based reasoning process that comprises the following steps:

1. Analyzing a problem situation by comparing it to relevant precedents.
2. Justifying deciding the problem situation like a particular precedent by focusing on their important similarities.
3. Justifying *not* deciding the problem situation like the precedent by distinguishing them and drawing competing analogies to counter-examples, real and hypothetical.
4. Making the strongest arguments on all sides of the issue by combining the precedential justifications – the analogies, distinctions, and comparisons to counter-examples.
5. Evaluating the competing arguments and deciding the problem situation accordingly.
6. Explaining the decision by discussing the competing arguments.

We have identified the kinds of domain knowledge that are necessary for adversarial, case-based reasoning and described in detail how they are implemented in HYPO:

1. A Case Knowledge Base of prior cases to cite in arguments.
2. An indexing scheme to access the cases that are relevant for making an argument.
3. A formal structure for making the arguments by analogy to prior cases.
4. Criteria for evaluating those arguments.

HYPO's Case Knowledge Base contains, at this writing, thirty real legal cases represented in a legal-case-frame language. Included in the representation of each case are its outcome, general facts and the particular features that were deemed to favor, or not to favor, the outcome.

HYPO employs a Dimensional Index. Dimensions represent features of cases that strengthen or weaken a side's argument in favor of a particular outcome. Dimensions define the ways in which cases are relevantly similar or different and facilitate comparing cases in terms of the magnitudes of those features. At this writing, there are thirteen implemented dimensions.

As a formal structure for making and evaluating case-citing arguments in HYPO, a 3-ply, turn-taking schematic has been specified consisting of a:

- Point for *Side 1* – where the dimension-based analogy between the problem situation and a favorable precedent is drawn.
- Response for the opponent, *Side 2* – consisting of dimension-guided distinctions between the problem situation and cited precedent and counter-examples to the precedent.

- Rebuttal, again for *Side 1* – consisting of a response to the counter-examples cited in the Response.

We have defined argument evaluation criteria in HYPO in terms of whether there are cases to cite for a particular side in a problem situation, how analogous or on point those cases are to the situation, and whether there are more on point cases to cite for the opponent.

At the heart of HYPO are its basic, case-based reasoning methods and its analytic structures, particularly dimensions, case-analysis-records and claim-lattices, for representing and interpreting the argument relations among cases. Five basic case-based operations have been identified and implemented:

1. Ordering analogous cases
2. Selecting most analogous cases
3. Identifying configurations of counter-examples among the most analogous cases
4. Posing hypotheticals to explore connections to neighboring cases.
5. Comparing case-based analyses of different problem situations.

HYPO employs the dimensions and case-analysis-record to take reciprocal views of the problem situation and the Case Knowledge Base. The case-analysis-record views the problem situation with respect to the existing cases in the CKB; the claim-lattice views the cases with respect to the problem situation. HYPO uses this information to determine the cases, and the aspects of the cases, that are relevant to the problem situation.

With the claim-lattices, HYPO determines which of the similarities and differences among the precedents are, in fact, most important with respect to the

particular problem situation. HYPO positions the current fact situation with respect to the relevant existing cases in the CKB as seen from the viewpoint of the problem situation. With the benefit of this ordering, HYPO selects the most analogous cases pro and con a decision and identifies configurations of counter-examples among them. Indeed, four kinds of counter-examples have been identified, each corresponding to a different configuration of cases in the claim-lattice or along shared dimensions and each having its own significance in terms of the argument.

HYPO's relevance assessments are dynamic because they depend on the particular configurations of cases and counter-examples around a particular problem situation. The fact that the problem situation shares a certain feature with a prior case may be overshadowed by the fact that it also shares other features with cases having opposite outcomes. Determining which features are more important is tailored to each problem situation. Moreover, as new cases are added to the CKB, the relative importance of features is, in effect, automatically adjusted.

Having located the problem situation within a neighborhood of relevant cases, HYPO's heuristic methods for generating hypotheticals allow it to explore that neighborhood. HYPO poses hypotheticals to test the sensitivity of the problem situation to various changes in the facts, to flesh out sparse areas of the CKB, and to create cases in which the precedents lead to conflicting outcomes.

HYPO's arguments are interpretations of the relationships among the problem situation and the precedents in the claim-lattice and along shared-dimensions. The points and responses are legally realistic and derivable from the information contained in the dimensions and claim-lattices. The arguments make explicit the relationships among the problem situation and its closest analogues and provide a medium for explaining the alternative ways of deciding the situation. HYPO explains its decisions by summarizing the most-on-point precedents with standard *Blue Book* citation labels, playing out the 3-ply arguments, suggesting hypothet-

icals to improve a side's position and comparing arguments.

This dissertation has addressed certain general issues of central concern to Artificial Intelligence including:

- Relevance
- Credit Assignment
- Inference Control and Indexing
- Analogical Reasoning
- Explanation

Relevance: The dissertation has identified the factors that make relevance assessment such a complex matter. The cases and features of cases that are *relevant* depend on:

1. **Ones purpose:** What precedent is relevant depends on what use one wants to make of it. If ones purpose is to convince or persuade, then relevance must reflect the criteria for making and evaluating an argument. Other purposes, for example, to tutor a student, may impose other evaluation criteria in addition to argument evaluation criteria.
2. **Context of the argument:** Given that ones purpose is to make convincing arguments, the relevance of a precedent, and the features of it that are salient, depend on the context of the argument, for example: whose side one takes, whether one makes a point or responds to one, whether one responds by distinguishing or citing a counter-example, what kind of counter-example one cites.
3. **Definition of Importance:** Whether a precedent is relevant depends on the similarities and differences that have been deemed to be important. The

criteria for importance need to be justifiable in terms of reasonable domain arguments just as does the importance of particular similarities and differences.

4. **Features Shared with Problem Situation:** Given that features, similarities and differences have been defined, a precedent's relevance depends on which features it shares and does not share with the problem situation.
5. **Other Precedents:** The relevance of a precedent also depends on the features that the problem situation shares with all other, possibly contradictory, precedents relative to those it shares with the precedent.

With its reciprocal views of the problem situation and CKB and dynamic relevancy assessment, HYPO flexibly interprets the relevance of a precedent in light of the specific facts of the problem situation, the other precedents and the context of the argument.

Credit assignment: Credit assignment is hard because, when comparing precedents, all other things are *not* equal. The cases are not neat. In most instances, the competing most-analogous cases do not differ relative to the problem situation and to each other in only one respect but in many. Their features overlap to various extents. The magnitudes of the features vary widely. In this light, it is clear why the knowledge engineer needs to avoid using *a priori* feature hierarchies to select the best matches among the most analogous cases. The relations among the features frozen in the hierarchy do not take into consideration the effects that the presence of other features or different magnitudes may have on their relevance in specific circumstances. Moreover, the decision of each new case affects the assessment of relevance in ways not necessarily reflected in the hierarchy.

HYPO deals realistically with the problems of credit assignment. It avoids static feature hierarchies. Its arguments and different response styles play out the

alternative interpretations of the precedents making explicit the reasons why it should, and should not, be followed. HYPO's tools for generating hypotheticals point to ways of making controlled comparisons among cases. Hypotheticals can be designed to present just the right mix of features for testing the significance of a particular feature where all other things are kept equal.

Inference Control and Indexing: HYPO's facility for making arguments demonstrates the utility of adopting strong, domain-dependent indices for controlling inference. The dimensional index reflects the specific ways that knowledge is organized in the legal domain to facilitate argument-making. The dimensional index supports reasoning about cases within the index, in particular, comparing cases in terms of which make stronger or weaker justifications for a given outcome. At the same time, the dimensional indexing method is general enough to be useful in non-legal domains where case comparisons are important.

Analogical Reasoning: HYPO provides a mechanism for analogical transfer where there is no strong domain theory for structuring explanations of prior cases that can be mapped to a problem situation. HYPO does not assume that a strong domain theory exists or that a best-matched target case is a model for an answer to the problem situation. Instead, HYPO combines information from competing most analogous precedents by treating them as competing justifications that are combined into arguments. Other analogy programs transform the differences among nearly analogous cases into point differentials in a matcher. The losers are discarded and no information is gained. By contrast, HYPO makes the comparisons among the best cases symbolically, draws inferences from them and transforms them into arguments.

Explanation: In this research, we have progressed beyond Explanation-Based Learning domains with their neat invertible operators into domains where there may be several ill-defined candidate theories. We have shown how adversarial, case-based methods can be used to make and explain decisions by comparing

the problem situation to similar cases from past experience, contrasting arguments by analogy for and against a decision and posing hypothetical cases to demonstrate possible new facts and arguments.

A difficult task has been undertaken in this dissertation: to build a system that *argues* the way experts do. Care has been taken to examine specifically how experts justify adversarial positions in a particular domain. Here, in a legal domain, justifications are not merely logical proofs but analogical comparisons to prior cases. A dimensionally-indexed Case Knowledge Base organizes the cases according to the ways that experts use them in making arguments. Claim-lattice and dimension mechanisms support computationally simple comparisons among the cases. The comparisons have been ascribed realistic argument interpretations. The result has been greater than the sum of its parts, a computer program, HYPO, that generates sophisticated arguments citing cases and hypotheticals comparable to those of legal experts.

A P P E N D I X A

Excerpts from Opinion

The following excerpts are taken from the opinion of the court in *USM Corp. v. Marson Fastener Corp.*, 379 Mass. 90, 98 - 103 (1979):

No general rule may be established to determine whether the security precautions taken by the possessor of a trade secret are reasonable. "Relevant factors to be considered include (1) the existence or absence of an express agreement restricting disclosure, (2) the nature and extent of security precautions taken by the possessor to prevent acquisition of the information by unauthorized third parties, (3) the circumstances under which the information was disclosed . . . to [any] employee to the extent that they give rise to a reasonable inference that further disclosure, without the consent of the possessor, is prohibited, and (4) the degree to which the information has been placed in the public domain or rendered 'readily ascertainable' by the third parties through patent applications or unrestricted product marketing." [citing a Michigan appellate court case.] . . .

USM required supervisory, technical, and research personnel, including the defendant Lahnston, to sign nondisclosure agreements. . . . While the nondisclosure agreements did not list the particular information which USM considered secret, such specificity is not required to put employees on notice that their work involves access to trade secrets and confidential information. See *Eastern Marble Prods. Corp. v. Roman Marble, Inc.*, 372 Mass. 835, 840 (1977). . . . Accord, *Kodekey Elecs., Inc. v. Mechanex Corp.*, 486 F. 2d 449, 455 (10th Cir. 1973) (nondisclosure agreements a "primary and essential precaution"); . . .

It is not fatal that the blueprints and parts drawings were not labeled "confidential" or "secret" or that USM had not expressly informed its employees that these part drawings were considered secret by USM. See *A. H. Emery Co. v. Marcan Prods. Corp.*, *supra* . . .

Similarly, the plant security precautions taken by USM were sufficient to exclude the general public from the production areas of USM's plants, thereby denying access to USM factory equipment, including the USM machine. The fact that USM conducted escorted tours for employees' families and USM product distributors, including certain defendants, does not militate against a finding that USM denied public access to the USM machine. Compare *Plant Indus., Inc. v. Coleman*, 287 F.Supp. 636, 643 (C.D. Cal. 1968) (tours by women's clubs and customers' representatives do not constitute failure to maintain secrecy) ... with *Motorola, Inc. v. Fairchild Camera & Instrument Corp.*, 366 F. Supp. 1173, 1186 (D. Ariz. 1973) (security inadequate where competitors toured plant, operated "secret" machine and "observed its 'secret' process in a separate microscope placed there for this purpose") ...

We do not require the possessor of a trade secret to take heroic measures to preserve its secrecy. ... The question whether a plaintiff has taken "all proper and reasonable steps" depends on the circumstances of each case, considering the nature of the information sought to be protected *as well as the conduct of the parties*. ...

Applying this standard, we denied trade secret protection in *Healy* because the plaintiff had made a conscious policy decision to do nothing to safeguard the confidentiality of its manufacturing processes. *J.T. Healy & Son v. James A. Murphy & Son*, *supra* at 737-738. In *Healy*, the employees were never informed that any of the manufacturing processes were considered secret; employees were not required to sign nondisclosure agreements; ... The plaintiff in *Healy*, other than excluding the general public from the manufacturing plant, took no security precautions whatever. ...

By contrast, in *Eastern Marble Prods. Corp. v. Roman Marble, Inc.*, 372 Mass. 835 (1977), trade secret protection was afforded a plaintiff who ... required all manufacturing employees "to sign an agreement not to disclose the methods and procedures involved in the [plaintiff's] manufacturing processes." ...

We think that, considering the character of the information which USM sought to protect, the steps taken by USM to preserve the secrecy of its trade secret were reasonable. Accord, *Eastern Marble Prods. Corp. v. Roman Marble, Inc. supra*. ... In short, USM's "efforts at secrecy, like the process itself, met the basic criterion of success." *Space Aero Prods. Co. v. R. E. Darling Co.*, 238 Md. 93, 112, cert. denied, 382 U.S. 843 (1965). See Restatement of Torts Sec.

757, Comment b (1939).

A P P E N D I X B

Excerpts from Plaintiff's Brief

The following excerpts are taken from the brief filed by the plaintiff's attorney in the *USM* Case:

The Master was in error in his conclusion of law, . . . , that USM had not sufficiently guarded the confidential information within its machine so as to qualify that information as a trade secret This error was based on a misinterpretation of the language of the Court in *J.T. Healy & Son, Inc. v. James A. Murphy & Sons, Inc.*, 357 Mass. 728, 738 (1970) ("Healy")

The *Healy* case was, of course, unique in that the owner of the allegedly secret process did absolutely nothing to guard it, and in the course of its opinion the Court described various precautionary measures which the *Healy* plaintiff had not taken, including the failure to enter into non-disclosure agreements or give its employees continual warnings and admonitions of secrecy Whatever might or might not be the correctness of the *Healy* decision on its own facts, some of its language was susceptible to the misinterpretation of establishing not only a set of specific secrecy requirements but, under an undefined "eternal vigilance" standard, an artificially extreme level of security which, as a practical matter, would tend to eliminate trade secrets as a viable means of protective development and use of confidential information and processes. . . .

[The Master and the Superior Court (i.e., the court below)] seem to have read the "eternal vigilance" language of "Healy" as establishing a list of precautionary measures, all of which have to be taken in every case in order to have anything qualify as a trade secret in any case. . . . Thus, for example, a predominant concern of both the Master and the Superior Court was with the fact that the USM machine was not kept constantly and carefully concealed from all observation,

without paying attention at all to the related fact, . . . , that the trade secret could not be in any way determined or duplicated through observation of the machine. . . . The plaintiffs in *Jet Spray* had not complied with all the precautionary measures mentioned in *Healy*, but the Court nevertheless held that their actions "clearly constituted sufficient and appropriate precautions [to maintain secrecy]" . . . In so holding, the *Jet Spray* Court . . . stated that "[I]n our view, the result in each case depends upon the conduct of the parties and the nature of the information" . . . See, also *Eastern Marble Products Corp. v. Roman Marble, Inc.* . . .

The undesirable effect of any such artificial approach, . . . , would be as a practical matter to encourage theft and other improper commercial practices by supporting the proposition that if a manufacturer's confidential information can be somehow misappropriated by improper means, it is not sufficiently safeguarded to qualify as a trade secret.

A P P E N D I X C

Excerpts from Defendant's Brief

The following excerpts are taken from the brief filed by the defendant's attorney in the in *USM* Case:

The court has stated the nature of this burden to maintain secrecy in great detail in *J.T. Healy & Son, Inc. v. James A. Murphy & Son, Inc., supra*:

"If the person entitled to a trade secret wishes to have its exclusive use in his own business, he must not fail to take all proper and reasonable steps to keep it secret. . . . [O]ne who claims that he has a trade secret must exercise eternal vigilance...." . . .

In all three of these cases [(i.e. the *Healy, Jet Spray Cooler*, and *Eastern Marble Products* cases, the court applied to the plaintiff's activities a requirement that all proper and reasonable steps be taken to protect the alleged secret process. The differences in result arise because in some instances a plaintiff has been able to meet that burden, while in others, the plaintiff's efforts have fallen short of the required standard....

The findings in this case contain numerous indications of the absence of security and secrecy regarding the USM machine. [Two defendants] each visited the plaintiff's plant and were allowed to observe and examine closely the plaintiff's machine in operation. . . . Cf. *Motorola, Inc. v. Fairchild Camera and Instrument Corp.*, 366 F. Supp. 1173, 1186 (D. Ariz. 1973). Neither they nor anyone else were notified in any manner that the machines they observed were secret or confidential. There was no effective control over plans and drawings at Shelton. Employees could thus easily obtain sepias and blueprints and remove them from the plant....

Although Lahnston was given an agreement to sign it was a form agreement designed primarily for research and development employees... The

fact that the agreement signed by Lahnston was a printed form bearing little relation to his actual duties reinforces the impression that USM did not make a serious effort to inform its employees such as Lahnston as to their obligations not to disclose trade secrets. ...

In *Motorola, Inc., supra* the court held a secrecy agreement invalid and stated:

“While the Motorola employee-defendants had executed the above-mentioned nondisclosure agreement, they were not advised upon execution, either generally or specifically, what, if any, production processes, know-how, or other things plaintiff considered proprietary. At no time during their employment were they so advised.” ...

Contrast this with the situation in *Eastern Marble Products Corp. v. Roman Marble, Inc., ...*, wherein the nondisclosure agreement specifically required employees not to disclose the methods and procedures involved in the manufacturing processes of Eastern Marble.

A P P E N D I X D

Uniform Trade Secrets Act

Section 1. [Definitions]

(1) "Improper means" includes theft, bribery, misrepresentation, breach or inducement of a breach of a duty to maintain secrecy, or espionage through electronic or other means;

(2) "Misappropriation" means:

(i) acquisition of a trade secret of another by a person who knows or has reason to know that the trade secret was acquired by improper means; or

(ii) disclosure or use of a trade secret of another without express or implied consent by a person who

(A) used improper means to acquire knowledge of the trade secret; or

(B) at the time of disclosure or use, knew or had reason to know that his knowledge of the trade secret was

(I) derived from or through a person who had utilized improper means to acquire it;

...

(4) "Trade secret" means information, including a formula, pattern, compilation, program, device, method, technique, or process, that:

(i) derives independent economic value, actual or potential, from not being generally known to, and not being readily ascertainable by proper means by, other persons who can obtain economic value from its disclosure or use, and

(ii) is the subject of efforts that are reasonable under the circumstances to maintain its secrecy.

Commissioner's Comment

...

Proper means include:

1. Discovery by independent invention;
2. Discovery by "reverse engineering", that is, by starting with the known product and working backward to find the method by which it was developed. The acquisition of the known product must of course, also be by a fair and honest means, such as purchase of the item on the open market for reverse engineering to be lawful;
3. Discovery under a license from the owner of the trade secret;
4. Observation of the item in public use or on public display;
5. Obtaining the trade secret from published literature.

A P P E N D I X E

Restatement of Torts—Section 757

Section 757. Liability for disclosure or use of another's trade secret – General Principle.

One who discloses or uses another's trade secret, without a privilege to do so, is liable to the other if

(a) he discovered the secret by improper means, or

(b) his disclosure or use constitutes a breach of confidence reposed in him by the other in disclosing the secret to him, or

(c) he learned the secret from a third person with notice of the facts that it was a secret and that the third person discovered it by improper means or that the third person's disclosure of it was otherwise a breach of his duty to the other, or

(d) he learned the secret with notice of the facts that it was a secret and that its disclosure was made to him by mistake.

Comment b. Definition of trade secret.

A trade secret may consist of any formula, pattern, device or compilation of information which is used in ones business, and which gives him an opportunity to obtain an advantage over competitors who do not know or use it. It may be a formula for a chemical compound, a process of manufacturing, treating or preserving materials, a pattern for a machine or other device, or a list of customers....A trade secret is a process or device for continuous use in the operation of the business. Generally it relates to the production of goods, as, for example, a machine or formula for the production of an article. It may, however, relate to the sale of goods or to other operations in the business, such as a code for determining discounts, rebates or other concessions in a price list or catalogue,

or a list of specialized customers, or a method of bookkeeping or other office management.

The subject matter of a trade secret must be secret. Matters of public knowledge or of general knowledge in an industry cannot be appropriated by one as his secret. Matters which are completely disclosed by the goods which one markets cannot be his secret. Substantially, a trade secret is known only in the particular business in which it is used. It is not requisite that only the proprietor of the business know it. He may, without losing his protection, communicate it to employees involved in its use. He may likewise communicate it to others pledged to secrecy. Others may also know of it independently, as, for example, when they have discovered the process or formula by independent invention and are keeping it secret. Nevertheless, a substantial element of secrecy must exist so that, except by the use of improper means, there would be difficulty in acquiring the information. An exact definition of a trade secret is not possible. Some factors to be considered in determining whether given information is ones trade secret are: (1) the extent to which the information is known outside of his business; (2) the extent to which it is known by employees and others involved in his business; (3) the extent of measures taken by him to guard the secrecy of the information; (4) the value of the information to him and to his competitors; (5) the amount of effort or money expended by him in developing the information; (6) the ease or difficulty with which the information could be properly acquired or duplicated by others.

A P P E N D I X F

Complete List of Legal-Case-Frames

Legal:

- CASE
- TYPE-OF-CLAIM
- PARTY-TO-LAWSUIT
- PERSON-PARTY
- CORPORATE-PARTY
- EMPLOYEE-PARTY

Actors:

- PERSON
- CORPORATION

Product-related:

- PRODUCT
- KNOWLEDGE
- PRODUCT-WORKED-ON
- INTRINSIC-SIMILARITIES
- SECURITY-BREACH
- DISCLOSURE-EVENT

Employment-related:

- EMPLOYEE
- EMPLOYMENT

- EMPLOYMENT-CHANGE

Contracts:

- AGREEMENT
- NONCOMPETITION-COV
NONDISCLOSURE-AGREEMENT
- PROMISE
- RELIANCE

A P P E N D I X G

Cases in the Case Knowledge Base

Amoco Production Co. v. Lindley, 609 P2d 733 (Okla. 1980) (Defendant won trade secrets misappropriation claim where plaintiff's former employee was sole developer of plaintiff's product and nondisclosure agreement did not specifically refer to it.)

Analogic Corp. v. Data Translation, Inc., 358 N.E.2d 804 (S.J.C. Mass. 1976) (Plaintiff won trade secrets misappropriation claim where defendant gained competitive advantage, plaintiff's employee brought product related tools to defendant, and employee entered into nondisclosure agreement.)

Automated Systems, Inc. v. Service Bureau Corp., 401 F.2d 619 (10 Cir. 1968) (Defendant won claim for trade secrets misappropriation where secrets about vertical business information and disclosures made to defendant in negotiations.)

Black, Sivals & Bryson, Inc. v. Keystone Steel Fabrication, Inc., 584 F2d 946 (10th Cir. 1978)

Com-Share, Inc. v. Computer Complex, Inc., 338 F.Supp. 1229 (E.D.Mich. 1971)

Crown Industries, Inc. v. Kawneer Co., 335 F. Supp. 749 (N.D. Ill. 1971) (Defendant won claim for trade secrets misappropriation where plaintiff disclosed secrets to 7 outsiders.)

Data General Corp. v. Digital Computer Controls Inc., 357 A.2d 105 (Del. Ch. 1975) (Plaintiff won claim for trade secrets misappropriation even though plaintiff disclosed secrets to 6000 outsiders where disclosures covered by nondisclosure agreements.)

Dougherty v. Salt, 227 N.Y. 200, 125 N.E. 94 (1919) (Defendant won contracts claim where contract not supported by consideration.)

Eastern Marble Products Corp. v. Roman Marble, Inc., 364 N.E.2d 799 (Mass. 1977) (Plaintiff won trade secrets misappropriation claim where adequate security measures taken and defendant entered into nondisclosure agreement.)

Hancock Bank & Trust Co. v. Shell Oil Co. (Defendant won contracts claim where contract not supported by consideration.)

J.T. Healy & Son, Inc. v. James A. Murphy & Son, Inc., 357 Mass. 728 (1970) (Defendant won trade secrets misappropriation claim where plaintiff took insufficient measures to protect secrets.)

Kirksey v. Kirksey, 8 Ala. 131 (1845) (Defendant won contracts claim where contract not supported by consideration.)

Kewanee Oil Co. v. Bicon Corp., 416 U.S. 470, 94 S.Ct. 1879, 40 L.Ed.2d 315 (1974) (Plaintiff won trade secrets misappropriation claim where there was nondisclosure agreement covering defendant's access.)

Laff v. John O. Butler Co., 381 N.E.2d 423, 64 Ill.App.3d 603 (1978) (Plaintiff won contracts claim.)

Midland-Ross Corp. v. Sunbeam Equipment Corp., 316 F. Supp 171 (W.D. Pa. 1970) (Defendant won claim for trade secrets misappropriation where plaintiff disclosed secrets to 150 outsiders.)

Midland-Ross Corp. v. Yokana, 293 F. 2d 411 (3 Cir. 1961) (Defendant won claim for trade secrets misappropriation where plaintiff disclosed secrets to outsiders.)

Modern Controls Inc. v. Andreadakis, 578 F.2d 1264 (8 Cir. 1978) (Plaintiff won claim for breach of noncompetition agreement.)

Motorola, Inc. v. Fairchild Camera and Instrument Corp., 366 F.Supp. 1173 (D. Arizona 1973) (Defendant won trade secrets misappropriation claim where nondisclosure agreements did not specifically refer to plaintiff's product.)

Peggy Lawton Kitchens, Inc. v. Hogan, 466 N.E.2d 138 (Mass. App. 1984) (Plaintiff won trade secrets misappropriation claim where adequate security measures taken.)

Plant Industries, Inc. v. Coleman, 287 F.Supp. 636 (C.D.Cal. 1968) (Plaintiff won trade secrets misappropriation claim where adequate security measures taken.)

Pressure Science Inc. v. Kramer, 413 F.Supp. 618 (D. Conn. 1976) (Defen-

dant won trade secrets misappropriation claim even though it gained competitive advantage.)

Raycorp v. Tronic (Hypothetical Case) (Defendant won trade secrets misappropriation claim even though there was an express noncompetition agreement.)

Schnell v. Nell, 17 Ind. 29 (1861) (Defendant won contracts claim where contract not supported by consideration.)

Schulenburg v. Signatrol, Inc., 212 N.E.2d 865, 33 Ill.2d 379 (1965) (Plaintiff won trade secrets misappropriation claim where defendant gained competitive advantage and paid plaintiff's former employee to switch employers.)

Space Aero Products Co. v. R.E. Darling Co., 208 A.2d 74 (Ct.App. Md. 1965) (Plaintiff won trade secrets misappropriation claim where defendant gained competitive advantage, bribed plaintiff's employee and brought product related tools to defendant even though plaintiff disclosed secrets to defendant in negotiations.)

Speedry Chemical Products, Inc. v. Carter's Ink Co., 306 F.2d 328 (2d Cir. 1962) (Defendant won trade secrets misappropriation claim where plaintiff disclosed secrets to defendant in negotiations.)

Sperry Rand Corp. v. Pentronix, 311 F. Supp. 910 (E.D.Pa. 1970)

Structural Dynamics Research Corp. v. Engineering Mechanics Research Corp., 401 F. Supp. 1102 (E.D.Mich. 1975) (Plaintiff won claim for trade secrets misappropriation where employees entered into nondisclosure agreements covering product of which they were sole developers.)

Telex Corp. v. IBM Corp., 367 F.Supp. 258 (N.D. Okl. 1973); aff'd in part, mod. in part, 510 F.2d 894 (10 Cir. 1975) (Plaintiff won claim for trade secrets misappropriation where defendant bribed plaintiff's employees to switch employers and gained competitive advantage.)

Trilog Associates, Inc. v. Famularo, 314 A.2d 287 (Pa. 1974)

USM Corp. v. Marson Fastener Corp., 379 Mass. 90 (1979) (Plaintiff won trade secrets misappropriation claim where adequate steps taken to protect secrets.)

Wexler v. Greenberg, 160 A.2d 430 (Sup. Ct. Pa. 1960) (Defendant won trade secrets misappropriation claim where plaintiff's former employee was sole developer of plaintiff's product.)

***Widget-King v. Cupcake* (Hypothetical Case) (Plaintiff won trade secrets misappropriation claim even though defendant gained competitive advantage.)**

The Squib for the *Data General* Case

Title: Data General Corp. v. Digital Computer Controls, Inc.

Cite: 357 A.2d 105 (Del. Ct. Chanc. 1975)

Date: November 7, 1975

Parties: Π: Data Gen.; Δ: Digital

Claim: Trade Secrets Misappropriation

Procedural Setting: Π denied preliminary injunction; seeks permanent injunction after trial.

Decision: Judgement for Π

Facts:

Data Gen. manufactured the Nova 1200 minicomputer. Digital ordered a Nova 1200 from a third party supplier. From the supplier, it also secured one of Π's maintenance manuals with design drawings from the supplier which it copied and returned. The drawings bore a proprietary legend prohibiting copying and the contract for the machine included a confidentiality agreement prohibiting use of the drawings for manufacture. Digital used the drawings to produce its D-116 minicomputer which was substantially identical to the Nova 1200. Π distributed the same drawings, bearing the same restrictive legend, to some 6000 customers, users, vendors and trainees. Π's sales contracts all prohibited the use of the drawings for manufacturing. Data Gen. took measures to protect its trade secrets including plant security, trainee confidentiality agreements, and stamping restrictive legends.

Issues: Did plaintiff lose its trade secret rights to the drawings by distributing them to 6000 outsiders?

Holding: For Π: No, the restrictive legends were sufficient to preclude disclosure to the public.

Cases cited:

The Squib for the *Amoco* Case

Title: *Amoco Production Co. v. Lindley*

Cite: 609 P.2d 733 (Sup. Ct. Okla.)

Date: 1980

Parties: Π : Amoco; Δ : Lindley

Claim: Breach of Nondisclosure Agreement, Trade Secrets Misappropriation

Procedural Setting: Δ appeals from lower court's granting Π a temporary injunction against Δ 's use or disclosure of information in connection with computer system developed by Δ .

Decision: In favor of Δ lifting the injunction.

Facts:

In 1964, Lindley, a well log analyst, entered into an employment agreement with Amoco to perform research related to oil and gas exploration. The agreement contained a provision under which Lindley agreed to disclose all inventions or discoveries to Amoco and not to disclose them to others. Starting in 1971, on his own time, Lindley developed a computer system (the "Lindley System" for analyzing well logs. Amoco refused to approve his development of the Lindley System in favor of another system ("AMS"), although they did order him to incorporate its features into the AMS system in 1973. In 1975, Amoco officially recognized the Lindley System when it was found responsible for discovering a large field of hydrocarbons. Ten months later, Lindley left Amoco in a dispute over the program. Amoco did not take any measures to protect secrecy of Lindley System such as controlling documents to maintain confidentiality.

Issues: (1) Was the Lindley System covered by the nondisclosure agreement?
(2) Did Lindley have right to use or disclose information connected with Lindley System?

Holding: (1) Held for Δ : Lindley system was not an invention and not covered by contract. (2) Held for Δ : Π did not take adequate measures to protect secret. Lindley developed system on his own.

Cases cited: re (2): *Telex Corp. v. IBM Corp.*, 367 F.Supp. 258 (N.D. Okla. 1973), rev'd on other gnds, 510 F.2d 894 (10th Cir. 1975); *Com-Share, Inc. v. Computer Complex, Inc.* 338 F. Supp. 1229 (E.D.Mich. 1971);

Structural Dynamics Research Corp. v. Engineering Mechanics Research Corp., 401 F. Supp. 1102 (E.D.Mich. 1975).

A P P E N D I X H

Implemented Dimensions In HYPO

1. *Competitive-Advantage-Gained*

Short Name: Competitive-Advantage

Claim: Trade Secrets Misappropriation

Generalization: Π strengthened the greater the competitive advantage gained by the defendant.

Focal Slots: INTERP-FRAME :claimant-makes-product1 PRODUCT :product-development-time

INTERP-FRAME :respondent-makes-product2 PRODUCT :expenditures-made

Ranges: 2 – 60 months, \$10000 – \$10,000,000

2. *Vertical-Knowledge*

Short Name: Vertical-Knowledge

Claim: Trade Secrets Misappropriation

Generalization: Plaintiff strengthened if knowledge does not pertain to customer business methods.

Focal Slots: INTERP-FRAME :exists-claimants-info-re-product1 KNOWLEDGE :kind-of-knowledge

Range: (vertical technical)

3. *Secrets-Voluntarily-Disclosed*

Short Name: Secrets-Disclosed-Outsiders

Claim: Trade Secrets Misappropriation

Generalization: Π strengthened the fewer disclosures to outsiders it has made of confidential information.

Focal Slots: INTERP-FRAME :exists-claimants-info-re-product1 KNOWL-
EDGE :number-disclosees

Range: 0 – 10,000,000

4. *Disclosures-Subject-To-Restriction*

Short Name: Outsider-Disclosures-Restricted

Claim: Trade Secrets Misappropriation

Generalization: Π strengthened to extent that disclosees are restricted from disclosing confidential information to others.

Focal Slots: INTERP-FRAME :exists-claimants-info-re-product1 KNOWL-
EDGE :percent-disclosees-restricted

Range: 0 – 100 %

5. *Agreement-Supported-By-Consideration*

Short Name: Consideration

Claim: Breach of Contract

Generalization: Π strengthened to extent that Δ received something of value for entering into contract.

Focal Slots: INTERP-FRAME :exists-purported-agreement AGREEMENT
:party-consideration-alist

Range: *nothing* v. *something* (e.g., *promise* *money*)

6. *Common-Employee-Paid-To-Change-Employers*

Short Name: Bribe-Employee

Claim: Trade Secrets Misappropriation

Generalization: Π strengthened the more Δ paid Π 's former employees with knowledge of the confidential information to switch employment.

Focal Slots: INTERP-FRAME :exists-employment-change EMPLOYMENT-
CHANGE :value-received-to-make-change-list

Range: *nothing* v. (*promise-of-higher-salary* *promise-of-promotion*
promise-of-stock *promise-of-bonus*)

7. *Exists-Express-Noncompetition-Agreement*

Short Name: Noncompetition-Agreement

Claim: Trade Secrets Misappropriation, Breach of Noncompetition Agree-
ment

Generalization: Π strengthened if employee entered noncompetition agreement.

Focal Slots: INTERP-FRAME :corp1-employee1-agreement

Range: nil v. NONCOMPETITION-COV

8. *Common-Employee-Transferred-Product-Tools*

Short Name: Brought-Tools

Claim: Trade Secrets Misappropriation

Generalization: Π strengthened if former employee brought product-related tools to Δ .

Focal Slots: INTERP-FRAME :exists-employment-change EMPLOYMENT-CHANGE :records-devices-code-brought-by-employment-list

Range: *nothing* v. (*development-notes* *source-code* *copy-of-product*)

9. *Nondisclosure-Agreement-Re-Defendant-Access*

Short Name: Agreed-Not-To-Disclose

Claim: Trade Secrets Misappropriation, Breach of Nondisclosure Agreement

Generalization: Π strengthened to extent Δ entered into a nondisclosure agreement.

Focal Slots: INTERP-FRAME :corp1-employee1-agreement

Range: *nothing* v. NONDISCLOSURE-AGREEMENT

10. *Common-Employee-Sole-Developer*

Short Name: Employee-Sole-Developer

Claim: Trade Secrets Misappropriation

Generalization: Π strengthened if Δ was not sole developer of the confidential information.

Focal Slots: INTERP-FRAME :exists-data-re-sole-developer

Range: *negative* v. *affirmative*

11. *Nondisclosure-Agreement-Specific*

Short Name: Nondisclose-Agreement-Specific

Claim: Trade Secrets Misappropriation, Breach of Nondisclosure Agreement

Generalization: Π strengthened if nondisclosure agreement specifically referred to Π 's product.

Focal Slots: INTERP-FRAME :exists-data-re-specificity

Range: *nothing* v. KNOWLEDGE

12. *Disclosure-In-Negotiations-With-Defendant*

Short Name: Disclosure-in-Negotiations

Claim: Trade Secrets Misappropriation

Generalization: Π strengthened to extent that it did not disclose secret to defendant in negotiations.

Focal Slots: INTERP-FRAME :info1-disclosed-corps-1-2-negotiations

Range: *negative* v. *affirmative*

13. *Security-Measures-Adopted*

Short Name: Security-Measures

Claim: Trade Secrets Misappropriation

Generalization: Π strengthened the more security measures it took to protect its confidential information.

Focal Slots: INTERP-FRAME :claimant-makes-product1 PRODUCT :security-measures-list

Range: (*minimal-measures* *access-to-premises-controlled* *restrictions-on-entry-by-visitors* *restrictions-on-entry-by-employees* *product-marked-confidential* *employee-trade-secret-program-exists* *restrictions-on-hardcopy-release* *employee-nondisclosure-agreements*)

A P P E N D I X I

Factual Predicates

- : exists-claimant-corp1**
There is a corporate Π .
(NIL, CORPORATE-PARTY, *negative*)
- : claimant-makes-product1**
Corporate Π makes a product.
(NIL, PRODUCT, *negative*)
- : exists-claimants-info-re-product1**
 Π has product information.
(NIL, KNOWLEGE, *negative*)
- : exists-respondent-corp2**
There is a corporate Δ .
(NIL, CORPORATE-PARTY, *negative*)
- : respondent-makes-product2**
Corporate Δ makes a product.
(NIL, PRODUCT, *negative*)
- : corps-1-2-compete**
Corporate Π and Δ are competitors.
(NIL, T, *negative*)
- : corps-1-2-compete-re-products-1-2**
Corporate Π and Δ products compete.
(NIL, T, *negative*)
- : exists-respondent-employee1**
There is an employee Δ .
(NIL, EMPLOYEE-PARTY, *negative*)
- : employee1-worked-for-claimant**
Employee Δ worked for Π .
(NIL, EMPLOYMENT, *negative*)

- : employee1-worked-for-respondent**
Employee Δ worked for corporate Δ .
(NIL, EMPLOYMENT, *negative*)
- : exists-common-employee1**
Employee Δ worked for both Π and Δ .
(NIL, T, *negative*)
- : exists-employment-change**
Employee Δ worked for Π before working for corporate Δ .
(NIL, EMPLOYMENT-CHANGE, *negative*)
- : employee-paid-to-switch**
Employee Δ received bribe to switch employment.
(NIL, list of items paid, *negative*)
- : employee-brought-product-tools**
Employee Δ brought Π 's product development tools with him.
(NIL, list of tools brought, *negative*)
- : employee-worked-on-product1**
Employee Δ worked on Π 's product.
(NIL, PRODUCT-WORKED-ON, *negative*)
- : corp2-access-product1-via-employee1**
Employee Δ worked on Π 's product and switched to working for Δ .
(NIL, DISCLOSURE-EVENT, *negative*)
- : corp1-employee1-agreement**
 Π and employee Δ had entered into an employment agreement.
(NIL, AGREEMENT, *negative*)
- : exists-person-asserting-contract**
There is a Π who is a party to a contract.
(NIL, PARTY-TO-LAWSUIT, *negative*)
- : exists-person-denying-contract**
There is a Δ who is a party to a contract.
(NIL, PARTY-TO-LAWSUIT, *negative*)
- : exists-purported-agreement**
There is some contractual agreement involved in the case.
(NIL, AGREEMENT, *negative*)
- : exists-disclosures-info1**
There is data that plaintiff made disclosures to outsiders.
(NIL, *affirmative*, *negative*)
- : exists-restrictions-disclosures-info1**
There is data that disclosures to outsiders were subject to restriction.
(NIL, *affirmative*, *negative*)

- : know-what-kind-info1**
There is data about the type of confidential product information, vertical or technical.
(NIL, list of vertical or technical, *negative*)
- : corp2-saved-expense**
Corporate Δ saved development time or cost in producing competing product.
(NIL, list of time or expense saved, *negative*)
- : exists-info-re-security-measures**
There is data regarding security measures taken by plaintiff.
(NIL, list of security measures, *negative*)
- : info1-disclosed-corps-1-2-negotiations** Π disclosed product information to Δ in negotiations.
(NIL, DISCLOSURE-EVENT, *negative*)
- : corp2-access-info1-via-disclosure**
 Δ accessed Π 's product information via a common employee or through negotiations.
(NIL, list of DISCLOSURE-EVENTs, *negative*)
- : nondisclosure-agreement-re-corp2-access**
Corporate or Employee Δ had entered into nondisclosure agreement with Π .
(NIL, NONDISCLOSURE-AGREEMENT, *negative*)
- : exists-data-re-specificity**
There is data whether nondisclosure agreement covered Π 's product.
(NIL, *affirmative*, *negative*)
- : exists-data-re-sole-developer**
There is data whether employee Δ was sole developer of Π 's product.
(NIL, *affirmative*, *negative*)

A P P E N D I X J

Glossary

Argument Evaluation Standards or Criteria: Standards for evaluating the strength of legal arguments that cite precedents. One of HYPO's basic sources of domain knowledge. See Chapter 4.

Argument-Record, Arg-Rec: Basic HYPO data structure for generating 3-Ply arguments. See Chapter 4.

Basic Processing Loop: The basic control loop in the HYPO program. See Chapter 4.

BEST-CASE-SELECTOR: HYPO module that selects from among the relevant cases, various types of most analogous cases including the most-on-point cases and best cases for plaintiff and defendant to cite. See Chapters 4 and 8.

boundary counter-example: a precedent whose features favor a particular outcome even more extremely than either the current fact situation or the precedent cited in the Point but where a different outcome was reached. See Chapter 4.

case: In law, a dispute between two parties, a plaintiff and a defendant, arising out of a specific fact situation, a lawsuit. See Chapters 3, 5 and Appendix G for sample legal cases.

Case-Analysis-Record, CAR, ACR: Basic HYPO data structure for recording results of dimensional analysis of a current fact situation and for keeping track of claim-lattices and arguments made about cfs. See Chapter 4.

CASE-ANALYZER: HYPO module that performs dimensional analysis of a current fact situation to determine what cases are relevant. See Chapter 4.

CASE EDITOR: HYPO module to assist attorney/user to input new fact situations, modify existing cases, or permanently store cases in the CKB. See Chapter 4.

CASE-POSITIONER: HYPO module that retrieves relevant cases from the CKB and organizes them according to how on point they are with respect to the current fact situation. See Chapter 4.

CBR, Case-Based Reasoning: A kind of reasoning where cases are employed as justifications for conclusions about or as models for solutions to a problem situation.

CEG, Constrained Example Generation: A research approach for reasoning by examples in which a "space" of examples is used. Examples are generated by modifying existing examples to meet various useful constraints.

cfs, current fact situation: The problem situation that HYPO currently is analyzing, retrieving cases relevant to, or making arguments about.

citable in first instance: Whether a precedent is good enough to cite in an initial point for a side or should be held in reserve to cite only if needed as a counter-example to the opponent's point.

citation signals: In law, labels for citing precedents that convey to reader how strongly the precedent supports the proposition for which it is cited. See Chapter 9.

cite: In law, to justify a legal conclusion, such as that a party in a case should win a claim, by formally referring to a legal authority such as a prior case, a statute or a legal reference work.

Cites Displays: In HYPO, output lists of cases that inform attorney/user what precedents can be cited for or against a party on a claim and how strongly they support the party's position. See Chapter 5 for examples.

CKB, Case Knowledge Base: HYPO's database of legal cases which are represented in the legal-case-frame language and indexed by dimensions. See Chapter 6.

claim: a recognized kind of legal complaint for which the courts will grant relief (e.g., negligence, malpractice, breach of contract, trade secrets misappropriation)

claim-lattice: In HYPO, the main tool for organizing relevant cases in the CKB in terms of how analogous or on point they are to a problem situation. See Chapters 4 and 8. Claim-lattices are used in selecting the best cases to cite and in locating counter-examples to cited precedents.

Common Law: The Anglo-American system of law in which prior cases are a source of law even in the absence of statutory or constitutional provisions. Distinguished from European Civil Law in which detailed statutory codes are the primary source of law.

counter-example: a case that in some sense is as analogous to a problem situation as a given case, but which had a different outcome. In HYPO, citing cases as counter-examples is a way of responding to points in a legal argument. See Chapter 4 and 8.

decision: In law, the court's selection of the winning party on a claim in a case.

defendant, Δ , δ : a party to a legal case who is sued by the plaintiff and defends against the claim alleged by the plaintiff.

dimension: a knowledge representation construct in HYPO for representing factors that make a party's position on a claim in a lawsuit stronger or weaker. Dimensions identify the features that are the bases of important similarities and differences among cases. See Chapters 4 and 7. Appendix 7 contains a complete listing.

Dimension Index: HYPO's primary indexing scheme for retrieving relevant precedents from the Case Knowledge Base. See Chapter 7.

distinguish: In law and HYPO, a way of responding to a point citing a precedent by pointing out the significant differences between the precedent and the current fact situation. See Chapters 3 and 4.

elements of a legal claim: In law, generalized statements of what facts must be proven in order to prevail on the claim. See Chapter 3.

EKB: A knowledge base of examples for use in reasoning by example about problem situations.

EBR, Example-Based Reasoning: Reasoning which employs retrieval, generation, analysis, modification or manipulation of examples for explanation, learning, discovery or debugging.

EXPLAINER: HYPO module that explains HYPO's analysis of current fact situation by summarizing best cases to cite, making 3-Ply arguments for and against a side's position, suggesting hypotheticals to strengthen the position, and comparing arguments. See Chapters 4 and 9.

factual predicates: Generalized factual tests for the existence of legally significant relationships in a case represented in HYPO's legal-case-frame language. Used in dimension prerequisites. See Chapters 4 and 7. Appendix I provides a complete listing.

focal slot: In HYPO, the focal slot of the dimension is the crucial value for comparing cases along a dimension. In a case to which the dimension applies, the focal slot value determines where the case lies along the range of the dimension. See Chapters 4 and 7.

hold, holding, hold in favor of: In a lawsuit, the court's resolution in favor of one side or the other of their dispute about a particular issue.

HYPO: A computer program which is the subject of this dissertation and which performs case-based reasoning in a legal domain.

HYPO-GENERATOR: HYPO module that generates hypothetical variants of the current fact situation or relevant cases to bolster points and responses. See Chapters 4 and 8.

hypothetical: A "made up" legal dispute that has not been decided by a court but whose fact situation is similar to that of real legal cases.

Interpretation-Frame, Interp-Frame: A basic HYPO data structure for recording the values in a fact situation of the factual predicates. See Chapter 4.

jurisprudence: The philosophy of law.

legal-case-frames: A frame-based language, implemented in flavors, for representing legal cases. See Chapters 4 and 6.

lines of cases: A series of legal cases presenting similar fact situations that were decided on similar grounds.

most-on-point: The most analogous cases to a problem situation as determined by relative degrees of overlap between sets of dimensions shared by cases and problem situation. Measured in HYPO by claim-lattices. See Chapters 4 and 8.

near-miss dimension: In HYPO, a dimension is a near-miss with respect to a problem situation if all of its prerequisites are satisfied except the one[s] associated with the focal slots of the dimension. See Chapter 7.

On Point: A symbolic measure of how analogous or close a prior case is to given fact situation. In HYPO, a prior case is on point to the extent that it shares the same strengths and weaknesses, as represented by dimensions, that are present in the current fact situation. See Chapters 4 and 8.

Open Textured: A predicate in a rule is open textured if it is not further defined by more detailed rules. Predicates in legal rules are commonly open textured. Only the cases that apply the predicates to specific fact situations provide a meaning for the predicates.

Overlapping Counter-example: In HYPO, a precedent that shares some of the features of the current fact situation that the precedent cited in a Point does but had a different outcome. See Chapter 4.

plaintiff, Π , π : a party to a legal case who sues the defendant by commencing a lawsuit and alleging a claim against the defendant.

Point: In law, a legal conclusion accompanied by citation to an authority to justify the conclusion. In HYPO, a Point is the first ply in a 3-Ply Argument where the legal conclusion is that a side in the current fact situation should win a claim, a prior case is cited and an analogy is drawn between the current fact situation and the cited case.

positioning: In HYPO, using claim-lattices to interpret and assess the relevancy of past cases to a current fact situation by seeing them from the viewpoint of the case at hand and finding the most on point cases.

potentially more-on-point counter-example: In HYPO, a precedent that is nearly more-on-point than the one cited in the Point but that had a different outcome. See Chapter 4.

potential most-on-point case: In HYPO, a case that would be more-on-point than a given case relative to a problem situation if the prerequisites of certain near-miss dimensions were added to the problem situation. Useful in suggesting hypotheticals to bolster points or responses. See Chapter 4.

precedent: In law, a prior case that can be cited to justify a legal conclusion.

prerequisites: In HYPO, a list of factual predicates that must be satisfied in a case for a dimension to apply to that case. See Chapter 7.

Rebuttal: In HYPO, the third ply of a 3-Ply Argument in which any counter-example cases cited in the Response are distinguished from the current fact situation. See Chapter 4.

Response: In HYPO, the second ply of a 3-Ply Argument in which the case cited in the Point is distinguished from the current fact situation and counter-examples are cited. See Chapter 4.

seed case: In HYPO, a case as represented in the legal-case-frame language, that serves as the basis for a hypothetical. A copy of the seed case is modified to produce a hypothetical variant of the seed case. See Chapter 8.

SESSION MANAGER: HYPO module that keeps track of cases and hypotheticals employed as current fact situations during the course of an attorney/user's session with HYPO. See Chapter 4.

Slippery Slope: A kind of argument tactic. One asserts that if a rule applied with a given result to a given fact situation, then it would also necessitate the same results in a series of hypothetical fact situations. Each hypothetical in the series is more exaggerated than the preceding one and demonstrates circumstances in which the result is more and more absurd.

- squib:** A structured summary of a legal case also known as a case brief. Commonly used in legal case-books and by law students to summarize important features of cases.
- stare decisis:** In law, the doctrine of the Common Law that a court's decision in a previous case is binding on the same or a lower court in a similar case.
- target case:** In HYPO, a case various of whose features are incorporated into a hypothetical variant of a seed case. See Chapter 8.
- top-level legal-case-frame:** A frame of HYPO's language for representing legal cases that represents a legal case's name, court, date, parties, winner, and claims as well as indexing information for retrieving the case from the Case Knowledge Base. See Chapter 6.
- 3-PLY-ARGUER:** HYPO module that generates 3-Ply Arguments about a current fact situation and suggests hypotheticals for improving the arguments. See Chapter 4.
- 3-Ply Argument:** Turn-taking schematic for a legal argument citing cases; consists of a point for *Side-1*, response for *Side-2* and rebuttal for *Side-1*. See Chapters 3 and 4.
- trade secrets misappropriation:** a kind of legal claim usually involving corporate competitors. The plaintiff corporation complains that the defendant corporation has gained access to plaintiff's secret information and used it to obtain an unfair competitive advantage. Most of the cases in HYPO's Case Knowledge Base deal with claims for trade secrets misappropriation. See Chapter 3 for a representative fact situation raising a trade secrets claim.
- trumping or most-on-point counter-example:** In HYPO, a precedent that is more analogous than the one cited in the point and had a different outcome. These are the strongest counter-examples to cite in a response. See Chapter 4.
- underlying legal-case-frame:** Frames of HYPO's language for representing legal cases that represent the facts of the case. See Chapter 6.

Bibliography

- [Alker Jr. and Christensen, 1972] Hayward R. Alker Jr. and Cheryl Christensen. From Causal Modelling to Artificial Intelligence: the Evolution of a UN Peace-Making Simulation. In J. La Ponce and Smoker P., editors, *Experimentation and Simulation in Political Science*, U. of Toronto Press, Toronto, 1972.
- [Allen and Saxon, 1987] Layman E. Allen and Charles S. Saxon. Some Problems in Designing Expert Systems to Aid Legal Reasoning. In *First International Conference on Artificial Intelligence and Law*, Northeastern University, Boston MA, 1987.
- [Ashley, 1985] Kevin D. Ashley. Reasoning by Analogy: A Survey of Selected A.I. Research with Implications for Legal Expert Systems. In Charles Walter, editor, *Computing Power and Legal Reasoning*, West Publishing Co., St. Paul, MN, 1985.
- [Ashley, 1986] Kevin D. Ashley. *Modelling Legal Argument: Reasoning with Cases and Hypotheticals - A Thesis Proposal*. Project Memo 10, The COUNSELOR Project, Department of Computer and Information Science, University of Massachusetts, 1986.
- [Ashley, 1987a] Kevin D. Ashley. Arguing by Analogy in Law: an A.I. Model. To appear in David H. Helman, editor, *Analogical Reasoning: Perspectives of Artificial Intelligence, Cognitive Science, and Philosophy*. D. Reidel, 1987.
- [Ashley, 1987b] Kevin D. Ashley. Distinguishing - A Reasoner's Wedge. In *Ninth Annual Cognitive Science Society Conference*, University of Washington, Seattle, 1987.
- [Ashley and Rissland, 1986] Kevin D. Ashley and Edwina L. Rissland. Toward Modelling Legal Argument. In Antonio A. Martino and F. Socci Natali, editors, *Automated Analysis of Legal Texts, Logic, Informatics, Law*, pages 19 - 30, Elsevier (North-Holland), 1986.

- [Ashley and Rissland, 1987a] Kevin D. Ashley and Edwina L. Rissland. But, See, Accord: Generating *Blue Book* Citations in HYPO. In *First International Conference on Artificial Intelligence and Law*, Northeastern University, Boston MA, 1987.
- [Ashley and Rissland, 1987b] Kevin D. Ashley and Edwina L. Rissland. Compare and Contrast, A Test of Expertise. In *Proceedings of the Sixth National Conference on Artificial Intelligence*, American Association for Artificial Intelligence, August 1987. Seattle.
- [Ashley and Rissland, 1988] Kevin D. Ashley and Edwina L. Rissland. Dynamic Assessment of Relevancy in a Case-Based Reasoner. In *Proceedings of the Fourth IEEE Conference on Artificial Intelligence Applications*, The Institute of Electrical and Electronics Engineers, Inc., March 1988. San Diego.
- [Bench-Capon *et al.*, 1987] T.J.M. Bench-Capon, G.O. Robinson, T.W. Routen, and M.J. Sergot. Logic Programming for Large Scale Applications in Law: A Formalism of Supplementary Benefit Legislation. In *First International Conference on Artificial Intelligence and Law*, Northeastern University, Boston MA, 1987.
- [Berman, 1968] H. J. Berman. Legal Reasoning. In *International Encyclopedia of the Social Sciences*, MacMillan, 1968.
- [Birnbaum, 1982] L. Birnbaum. Argument Molecules: A Functional Representation of Argument Structure. In *Proceedings of the Second National Conference on Artificial Intelligence*, American Association for Artificial Intelligence, Pittsburgh, PA, August 1982.
- [Birnbaum *et al.*, 1980] L. Birnbaum, M. Flowers, and R. McGuire. Towards an AI Model of Argumentation. In *Proceedings of the First National Conference on Artificial Intelligence*, pages 313–315, American Association for Artificial Intelligence, August 1980. Stanford, CA.
- [Blair and Maron, 1985] David C. Blair and M. E. Maron. An Evaluation of Retrieval Effectiveness for a Full-Text Document-Retrieval System. *Communications of the ACM*, 28(3):289–299, March 1985.
- [Blue Book, 1986] Blue Book. *A Uniform System of Citation*. The Harvard Law Review Association, Cambridge, MA, fourteenth edition, 1986.
- [Buchanan and Headrick, 1970] Bruce G. Buchanan and Thomas E. Headrick. *Some Speculation About Artificial Intelligence and Legal Reasoning*. Project Memo AIM 123, Stanford Artificial Intelligence Project, 1970.

- [Burstein, 1983a] M. H. Burstein. A Model of Learning by Incremental Analogical Reasoning and Debugging. In *Proceedings of the Third National Conference on Artificial Intelligence*, American Association for Artificial Intelligence, Washington, D.C., August 1983.
- [Burstein, 1983b] M. H. Burstein. Concept Formation by Incremental Analogical Reasoning and Debugging. In *Proceedings International Machine Learning Workshop*, Monticello, IL, June 1983.
- [Burton, 1985] Steven J. Burton. *An Introduction to Law and Legal Reasoning*. Little, Brown, Boston, 1985.
- [Carbonell, 1981] J. G. Carbonell. A Computational Model of Problem Solving by Analogy. In *Proceedings of the Seventh International Joint Conference on Artificial Intelligence*, International Joint Conferences on Artificial Intelligence, Inc., Vancouver, B.C., August 1981.
- [Carbonell, 1982] J. G. Carbonell. Experiential Learning in Analogical Problem Solving. In *Proceedings of the Second National Conference on Artificial Intelligence*, American Association for Artificial Intelligence, Pittsburgh, PA, August 1982.
- [Carbonell, 1983a] J. G. Carbonell. Derivational Analogy and its Role in Problem Solving. In *Proceedings of the Third National Conference on Artificial Intelligence*, American Association for Artificial Intelligence, Washington, D.C., August 1983.
- [Carbonell, 1983b] J. G. Carbonell. Derivational Analogy in Problem Solving and Knowledge Acquisition. In *Proceedings International Machine Learning Workshop*, Monticello, IL, June 1983.
- [Carbonell, 1983c] J. G. Carbonell. Learning by Analogy: Formulating and Generalizing Plans from Past Experience. In Michalski, J.G. Carbonell, and T. Mitchell, editors, *Machine Learning: An Artificial Intelligence Approach*, Tioga Publishing, CA, 1983.
- [Carbonell, 1986] J. G. Carbonell. Derivational Analogy: A Theory of Reconstructive Problem Solving and Expertise Acquisition. In R. S. Michalski, J.G. Carbonell, and T.M. Mitchell, editors, *Machine Learning: An Artificial Intelligence Approach, Volume II*, Morgan Kaufmann, Los Altos, CA, 1986.
- [Clancey, 1983] W.J. Clancey. The Epistemology of a Rule-based Expert System: A Framework for Explanation. *Artificial Intelligence*, 20(3):215-251, 1983.

- [Clancey, 1984] William J. Clancey. Classification Problem Solving. In *Proceedings of the Fourth National Conference on Artificial Intelligence*, American Association for Artificial Intelligence, Austin, TX, August 1984.
- [Cohen, 1984] Paul R. Cohen. *Progress Report on the Theory of Endorsements: A Heuristic Approach to Reasoning about Uncertainty*. Technical Report 84-15, Department of Computer and Information Science, University of Massachusetts, Amherst, MA, 1984.
- [Cohen, 1983] Robin Cohen. *Computational Model for the Analysis of Arguments*. Technical Report CSRG-151, Department of Computer Science, University of Toronto, 1983.
- [De Jong and Mooney, 1986] G. De Jong and R. Mooney. Explanation-Based Learning: An Alternative View. *Machine Learning*, 1(2), 1986.
- [Doyle, 1986] Richard J. Doyle. Constructing and Refining Causal Explanations from an Inconsistent Domain Theory. In *Proceedings of the Fifth National Conference on Artificial Intelligence*, American Association for Artificial Intelligence, August 1986. Philadelphia, PA.
- [Dworkin, 1977] Ronald Dworkin. *Taking Rights Seriously*. Harvard, Cambridge, MA, 1977.
- [Dworkin, 1978] R. Dworkin. No Right Answer? *New York University Law Review*, 53:1-32, 1978.
- [Dworkin, 1985] Ronald Dworkin. *A Matter of Principle*. Harvard, Cambridge, MA, 1985.
- [Evans, 1968] T.G. Evans. A Program for the Solution of Geometric Analogy Intelligence Test Questions. In Marvin Minsky, editor, *Semantic Information Processing*, M.I.T. Press, Cambridge, MA, 1968.
- [Flowers *et al.*, 1982] M. Flowers, R. McGuire, and L. Birnbaum. Adversary Arguments and the Logic of Personal Attacks. In W. Lehnert and M. Ringle, editors, *Strategies for Natural Language Processing*, Lawrence Erlbaum Associates, Hillsdale, NJ, 1982.
- [Fu and Buchanan, 1985] Li-Min Fu and Bruce G. Buchanan. *Inductive Knowledge Acquisition for Rule-Based Expert Systems*. Report KSL-85-42, Knowledge Systems Laboratory, Department of Computer Science, Stanford University, 1985. To Appear in *AI Journal*.

- [Gardner, 1984] A. vdL. Gardner. *An Artificial Intelligence Approach to Legal Reasoning*. PhD thesis, Department of Computer Science, Stanford University, 1984.
- [Gardner, 1987] A. vdL. Gardner. *An Artificial Intelligence Approach to Legal Reasoning*. MIT Press, Cambridge, MA, 1987.
- [Gentner, 1983] D. Gentner. Structure-Mapping: A Theoretical Framework for Analogy. *Cognitive Science*, 7:155–170, 1983.
- [Gewirtz, 1981] Paul Gewirtz. The Jurisprudence of Hypotheticals. *American Bar Association Journal*, 67:864–866, 1981.
- [Gilburne and Johnston, 1982] M. R. Gilburne and R. L. Johnston. Trade Secret Protection for Software Generally and in the Mass Market. *Computer/Law Journal*, III(3), 1982.
- [Goldman *et al.*, 1987] Seth R. Goldman, Michael G. Dyer, and Margot Flowers. Precedent-Based Legal Reasoning and Knowledge Acquisition in Contract Law: A Process Model. In *First International Conference on Artificial Intelligence and Law*, Northeastern University, Boston MA, 1987.
- [Hafner, 1987] Carol D. Hafner. Conceptual Organization of Case Law Knowledge Bases. In *First International Conference on Artificial Intelligence and Law*, Northeastern University, Boston MA, 1987.
- [Hammond, 1986a] Kristian J. Hammond. CHEF: A Model of Case-based Planning. In *Proceedings of the Fifth National Conference on Artificial Intelligence*, American Association for Artificial Intelligence, August 1986. Philadelphia, PA.
- [Hammond, 1986b] Kristian J. Hammond. Learning to Anticipate and Avoid Planning Problems through the Explanation of Failures. In *Proceedings of the Fifth National Conference on Artificial Intelligence*, American Association for Artificial Intelligence, August 1986. Philadelphia, PA.
- [Hammond, 1987] Kristian J. Hammond. Explaining and Repairing Plans that Fail. In *Proceedings of the Tenth International Joint Conference on Artificial Intelligence*, International Joint Conferences on Artificial Intelligence, Inc., August 1987. Milan, Italy.
- [Hart, 1961] H.L.A. Hart. *The Concept of Law*. Clarendon Press, Oxford, 1961.
- [Holyoak and Thagard, 1987] Keith J. Holyoak and Paul Thagard. Analogical Mapping by Constraint Satisfaction: A Computational Theory. 1987. Manuscript.

- [Kedar-Cabelli, 1984] S. Kedar-Cabelli. *Analogy with Purpose in Legal Reasoning from Precedents A Dissertation Proposal*. Technical Report LRP-TR-17, Laboratory for Computer Science Research, Rutgers University, 1984.
- [Kling, 1971] R. E. Kling. A Paradigm for Reasoning by Analogy. *Artificial Intelligence*, 2:147-178, 1971.
- [Kolodner, 1983a] Janet L. Kolodner. Maintaining Organization in a Dynamic Long-Term Memory. *Cognitive Science*, 7(4):243-280, 1983.
- [Kolodner, 1983b] Janet L. Kolodner. Reconstructive Memory: A Computer Model. *Cognitive Science*, 7(4):281-328, 1983.
- [Kolodner et al., 1985] Janet L. Kolodner, Robert L. Simpson, and Katia Sycara-Cyranski. A Process Model of Case-Based Reasoning in Problem Solving. In *Proceedings of the Ninth International Joint Conference on Artificial Intelligence*, International Joint Conferences on Artificial Intelligence, Inc., Los Angeles, CA, August 1985.
- [Kuhn, 1970] T. S. Kuhn. *The Structure of Scientific Revolutions*. U. Chicago, 1970.
- [Kurland and Casper, 1985] Philip B. Kurland and Gerhard Casper, editors. *Landmark Briefs and Arguments of the Supreme Court of the United States: Constitutional Law, 1983 Term Supplement*. Volume 151, University Publications of America, Inc., Frederick, MD, 1985.
- [Lakatos, 1976] I. Lakatos. *Proofs and Refutations*. Cambridge University Press, London, 1976.
- [Lenat, 1977] D. B. Lenat. Automated Theory Formation in Mathematics. In *Proceedings of the Fifth International Joint Conference on Artificial Intelligence*, pages 833-841, International Joint Conferences on Artificial Intelligence, Inc., Cambridge, MA, August 1977.
- [Levi, 1949] Edward H. Levi. *An Introduction to Legal Reasoning*. University of Chicago Press, 1949.
- [Llewellyn, 1930] K.N. Llewellyn. *The Bramble Bush: On Our Law and Its Study*. Oceana Publications, Dobbs Ferry, NY, 1960 edition, 1930.
- [Llewellyn, 1933] Karl N. Llewellyn. Praejudizienrecht und Rechtssprechung in Amerika. 1933. Section 52, Certainty in Case Law; In Doubtful Cases the Legal Rule is not Decisive, pages 72-86.

- [Llewellyn, 1938] Karl N. Llewellyn. On Our Case Law of Contract: Offer and Acceptance. *Yale Law Journal*, 48, 1938.
- [McCarty, 1980a] L. Thorne McCarty. *A Computational Theory of Eisner v. Macomber*. Technical Report LRP-TR-9, Laboratory for Computer Science Research, Rutgers University, 1980.
- [McCarty, 1980b] L. Thorne McCarty. Example Generation. In *Third Biennial Conference of the Canadian Society for Computational Studies of Intelligence*, University of Victoria, Victoria, B.C., 1980.
- [McCarty, 1985] L. Thorne McCarty. Permissions and Obligations. In Charles Walter, editor, *Computing Power and Legal Reasoning*, West Publishing Co., St. Paul, MN, 1985.
- [McCarty and Sridharan, 1981] L. Thorne McCarty and N.S. Sridharan. The Representation of an Evolving System of Legal Concepts: II. Prototypes and Deformations. In *Proceedings of the Seventh International Joint Conference on Artificial Intelligence*, International Joint Conferences on Artificial Intelligence, Inc., Vancouver, B.C., August 1981.
- [McCarty and Sridharan, 1982] L. Thorne McCarty and N.S. Sridharan. *A Computational Theory of Legal Argument*. Technical Report LRP-TR-13, Laboratory for Computer Science Research, Rutgers University, 1982.
- [McDonald and Pustejovsky, 1985] D. D. McDonald and J. Pustejovsky. Multi-level, Description-Directed, Goal-Driven Natural Language Generation. In *Proceedings of the Ninth International Joint Conference on Artificial Intelligence*, International Joint Conferences on Artificial Intelligence, Inc., Los Angeles, CA, August 1985.
- [McGuire *et al.*, 1981] R. McGuire, L. Birnbaum, and M. Flowers. Opportunistic Processing in Arguments. In *Proceedings of the Seventh International Joint Conference on Artificial Intelligence*, pages 58-60, International Joint Conferences on Artificial Intelligence, Inc., Vancouver, B.C., August 1981.
- [McKeown *et al.*, 1985] Kathleen R. McKeown, Myron Wish, and Kevin Matthews. Tailoring Explanations for the User. In *Proceedings of the Ninth International Joint Conference on Artificial Intelligence*, International Joint Conferences on Artificial Intelligence, Inc., Los Angeles, CA, August 1985.
- [Meldman, 1977] Jeffrey A. Meldman. A Structural Model for Computer-Aided Legal Analysis. *Journal of Computers and the Law*, 6:27-71, 1977.

- [Michaelsen, 1984] R. H. Michaelsen. An Expert System for Federal Tax Planning. *Expert Systems*, 1(2), October 1984.
- [Milgrim, 1985] Roger M. Milgrim. *Business Organizations, Milgrim on Trade Secrets*. Volume 12, Matthew Bender, New York, 1985.
- [Mitchell et al., 1983] T.M. Mitchell, P.E. Utgoff, and R.B. Banerji. Learning by Experimentation: Acquiring and Refining Problem-Solving Heuristics. In Michalski, Carbonell, and Mitchell, editors, *Machine Learning An Artificial Intelligence Approach*, pages 163-190, Tioga, 1983.
- [Murray, 1982] Murray. The Role of Analogy in Legal Reasoning. *UCLA Law Review*, 29:833, 1982.
- [Neustadt and May, 1986] R. E. Neustadt and E. R. May. *Thinking in Time*. The Free Press, New York, 1986.
- [Nimmer, 1985] Raymond T. Nimmer. *The Law of Computer Technology*. Warren, Gorham, & Lamont, Boston, 1985.
- [Perelman, 1982] C. Perelman. *The Realm of Rhetoric*. University of Notre Dame Press, 1982.
- [Polya, 1973] G. Polya. *How To Solve It*. Princeton University Press, second edition, 1973.
- [Radin, 1933] Max Radin. Case Law and Stare Decisis. *Columbia Law Review*, 33:199, 1933.
- [Rawls, 1971] John Rawls. *A Theory of Justice*. Harvard, Cambridge, MA, 1971.
- [Reichman, 1981] R. Reichman. Modeling Informal Debates. In *Proceedings of the Seventh International Joint Conference on Artificial Intelligence*, International Joint Conferences on Artificial Intelligence, Inc., Vancouver, B.C., August 1981.
- [Reichman-Adar, 1984] R. Reichman-Adar. Extended Person-Machine Interface. *Artificial Intelligence*, 22:157-218, 1984.
- [Rendell, 1985] L. Rendell. Substantial Constructive Induction Using Layered Information Compression: Tractable Feature Formation in Search. In *Proceedings of the Ninth International Joint Conference on Artificial Intelligence*, pages 650-658, International Joint Conferences on Artificial Intelligence, Inc., Los Angeles, CA, August 1985.

- [Rissland, 1978] Edwina L. Rissland. Understanding Understanding Mathematics. *Cognitive Science*, 1(4), 1978.
- [Rissland, 1980] Edwina L. Rissland. Example Generation. In *Third Biennial Conference of the Canadian Society for Computational Studies of Intelligence*, University of Victoria, Victoria, B.C., 1980.
- [Rissland, 1982] Edwina L. Rissland. Examples in the Legal Domain: Hypotheticals in Contract Law. In *Fourth Annual Cognitive Science Society Conference*, University of Michigan, Ann Arbor, 1982.
- [Rissland, 1983] Edwina L. Rissland. Examples in Legal Reasoning: Legal Hypotheticals. In *Proceedings of the Eighth International Joint Conference on Artificial Intelligence*, International Joint Conferences on Artificial Intelligence, Inc., Karlsruhe, Germany, August 1983.
- [Rissland, 1984] Edwina L. Rissland. Hypothetically Speaking: Experience and Reasoning in the Law. In *Proceedings First Annual Conference on Theoretical Issues in Conceptual Information Processing*, Georgia Institute of Technology, Atlanta, GA, March 1984.
- [Rissland, 1985] Edwina L. Rissland. AI and Legal Reasoning, Panel Report. In *Proceedings of the Ninth International Joint Conference on Artificial Intelligence*, International Joint Conferences on Artificial Intelligence, Inc., Los Angeles, CA, August 1985.
- [Rissland and Ashley, 1986] Edwina L. Rissland and Kevin D. Ashley. Hypotheticals as Heuristic Device. In *Proceedings of the Fifth National Conference on Artificial Intelligence*, American Association for Artificial Intelligence, August 1986. Philadelphia, PA.
- [Rissland and Ashley, 1987] Edwina L. Rissland and Kevin D. Ashley. A Case-Based System for Trade Secrets Law. In *First International Conference on Artificial Intelligence and Law*, Northeastern University, Boston MA, 1987.
- [Rissland *et al.*, 1984] Edwina L. Rissland, E. M. Valcarce, and Kevin D. Ashley. Explaining and Arguing with Examples. In *Proceedings of the Fourth National Conference on Artificial Intelligence*, American Association for Artificial Intelligence, Austin, TX, August 1984.
- [Rissland *et al.*, 1986] Edwina L. Rissland, Bruce G. Buchanan, Paul Rosenbloom, and H. T. Ng. *Intelligent Example Selection: Empirical Experiments with Near-Misses*. 1986. Submitted for Publication.

- [Samuel, 1963] A. Samuel. Some Studies in Machine Learning Using the Game of Checkers. In Feigenbaum and Feldman, editors, *Computers and Thought*, pages 71–105, McGraw-Hill, 1963.
- [Schlobohm and Waterman, 1987] Dean A. Schlobohm and Donald A. Waterman. Explanation for an Expert System that Performs Estate Planning. In *First International Conference on Artificial Intelligence and Law*, Northeastern University, Boston MA, 1987.
- [Sergot *et al.*, 1986] Sergot, Sadri, Kowalski, Kriwaczek, Hammond, and Cory. The British Nationality Act as a Logic Program. *Communications of the ACM*, 29(5):370–386, May 1986.
- [Sprowl, 1976a] James A. Sprowl. Computer-Assisted Legal Research—An Analysis of Full-Text Document Retrieval Systems, Particularly the Lexis System. *American Bar Foundation Research Journal*, 1976:175, 1976.
- [Sprowl, 1976b] James A. Sprowl. The Westlaw System – A Different Approach to Computer-Assisted Legal Research. *Jurimetrics*, 16(3), 1976.
- [Stick, 1986] John Stick. Can Nihilism be Pragmatic? *Harvard Law Review*, 100(2):332–401, December 1986.
- [SUP] SUP. The Complete Oral Arguments of the Supreme Court of the United States. University Publications of America, Frederick, MD.
- [Toulmin, 1958] Stephen Toulmin. *The Uses of Argument*. Cambridge U. Press, 1958.
- [Utgoff, 1983] Paul E. Utgoff. Adjusting Bias in Concept Learning. In *Proceedings of the International Machine Learning Workshop*, pages 105–109, Monticello, IL, 1983.
- [Waterman and Peterson, 1980] D. A. Waterman and M. Peterson. Rule-Based Models of Legal Expertise. In *Proceedings of the First National Conference on Artificial Intelligence*, American Association for Artificial Intelligence, Stanford, CA, August 1980.
- [Waterman and Peterson, 1981] D. A. Waterman and M. Peterson. *Models of Legal Decisionmaking*. Technical Report R-2717-1CJ, The Rand Corporation, Santa Monica, CA, 1981.
- [Wellman, 1985] Vincent A. Wellman. Practical Reasoning and Judicial Justification: Toward an Adequate Theory. *University of Colorado Law Review*, 57:45–115, 1985.

- [Winston, 1980] Patrick H. Winston. Learning and Reasoning by Analogy. *Communications of the ACM*, 23(12):689-703, 1980.
- [Yu *et al.*, 1984] Victor L. Yu, Lawrence M. Fagan, Sharon W. Bennett, William J. Clancey, A. Carlisle Scott, John F. Hannigan, Robert L. Blum, Bruce G. Buchanan, and Stanley N. Cohen. An Evaluation of MYCIN's Advice. In Buchanan, Bruce G. and Shortliffe, Edward H., editor, *Rule-Based Expert Systems*, chapter 31, pages 589-596, Addison-Wesley, Reading, MA, 1984.